

CUTTING PLOTTER
CG-60st
OPERATION MANUAL

MIMAKI ENGINEERING CO., LTD.

TKB Gotenyama Building, 5-9-41, Kitashinagawa, Shinagawa-ku, Tokyo 141-0001, Japan

Phone: +81-3-5420-8671 Fax: +81-3-5420-8687

URL: <http://www.mimaki.co.jp>

Foreword

Thank you for purchasing a MIMAKI CG-60st model of cutting plotter.

This Operation Manual describes how to handle and operate the CG-60st model of cutting plotter (hereinafter called the "Device").

Please read and fully understand this Operation Manual before putting the machine into service. It is also necessary to keep this Operation Manual on hand.

REQUESTS

- This Operation Manual has been carefully prepared for your easy understanding, however, please do not hesitate to contact a distributor in your district or our office if you have any inquiry.
- Description contained in this Operation Manual are subject to change without notice prior.
- In the case where this Operation Manual should be illegible due to destruction by fire or breakage, purchase another copy of the Operation Manual from a distributor in your district.

Precautions

Be sure to follow the below-stated precautions when using the device.

Safety precautions

Thoroughly read this Operation Manual to avoid danger.

Be sure to carefully read this Operation Manual, fully understand the description and make yourself familiar to the operation of the device so as to ensure safe use of the device.

Limited application

The device is intended to be used for cutting sheets (PVC sheets, fluorescent sheets, reflective sheets, etc.) and plotting and pouncing on drawing paper. Never use the device in any application other than the aforementioned intended ones.

Clothes to be worn in work

Never worn clothes that can interfere with your work (such as loose-fit clothes and accessories).

In addition, bind your hair, if long.

Precautions in use

- Keep away from a grid roller while it is rotating. A rotating grid roller can be so hazardous to your person as to abrade fingertip skin or tear off fingernails, if touched.
- While the device is engaged in cutting (plotting), keep head and hands away from any moving part of the device. A moving part of the device can catch hair or cause accidental injuries, if approached.
- Never swing a cutter to avoid danger. Blade can project from the cutter, if swung.
- Do not store the device with its pinch rollers lowered. Be sure to raise the pinch rollers whenever the machine is not in operation. If the machine is left unused with its pinch rollers lowered, the pinch rollers can deform and fail to retain sheets.
- Do not make any modification on the machine. It could cause an electric shock or a malfunction. We also don't warrant any modified device.
- Do not put the heavy stuff on Y cover. It may deform and then cause a contact to a carriage.

Safety labels

The device is adhered with a safety label that informs the customer of possible risks associated with the device.

Be sure to understand the correct meaning of the safety label to avoid danger.

If the safety label is illegible due to stains or has come off, purchase a new one from our sales office.

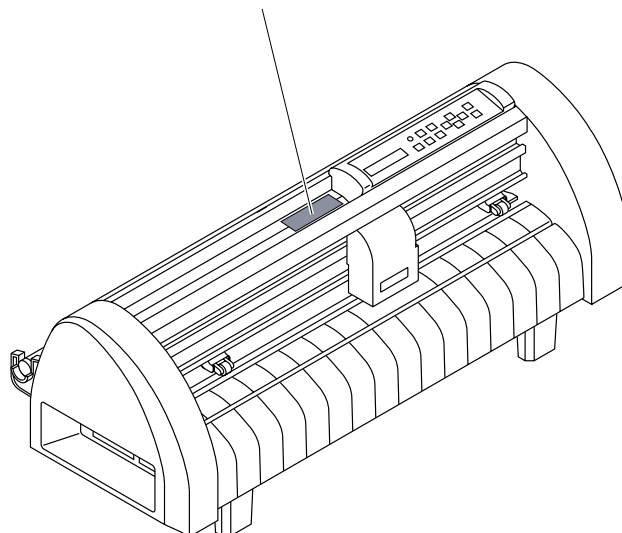
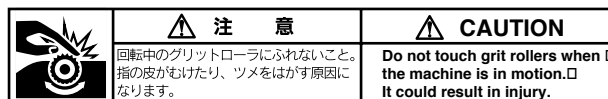

How to use the operation manual

Signs and symbols

For the purpose of this Operation Manual, the below-stated signs are attached to important items and helpful descriptions to be remembered to prevent possible accidents and troubles and to make the most out of the device.



This represents a caution.

It is attached to items and descriptions given to warn the customer against possible risks of personal injury, failures of the device or incorrect data.



This represents a hint.

It is attached to items and descriptions given to help the customer for better results.

Display panel/keys

The display panel and keys appear in the below-stated style.





Display		
	<p>This represents the description shown on the display panel of the device. In this manual, it is given in brackets as [SET UP].</p>	<p>In such a case as to enter a setting, the cursor location flashes on and off on the display panel. In this manual, the cursor location that flashes on and off is given with crosshatched.</p>
keys	<p>Keys are represented as given below both in the illustrations and the text.</p> <div style="display: flex; justify-content: space-around; align-items: center;"> <div style="border: 1px solid black; padding: 2px 5px;">END</div> <div style="border: 1px solid black; padding: 2px 5px;">ENTER</div> <div style="border: 1px solid black; padding: 2px 5px;">FEED</div> <div style="border: 1px solid black; padding: 2px 5px;">FUNCTION</div> <div style="border: 1px solid black; padding: 2px 5px;">REMOTE</div> <div style="border: 1px solid black; padding: 2px 5px;">SHEET SET</div> <div style="border: 1px solid black; padding: 2px 5px;">TOOL</div> </div> <div style="display: flex; justify-content: space-around; align-items: center; margin-top: 5px;"> <div style="border: 1px solid black; padding: 2px 5px;">◀</div> <div style="border: 1px solid black; padding: 2px 5px;">▶</div> <div style="border: 1px solid black; padding: 2px 5px;">▲</div> <div style="border: 1px solid black; padding: 2px 5px;">▼</div> </div>	

TABLE OF CONTENTS

<p>Foreword 2</p> <p>Precautions 2</p> <p>Safety labels 2</p> <p>How to use the operation manual 3</p> <p>Checking the accessories 4</p> <p>Configuration of the main unit 4</p> <p style="padding-left: 20px;">Front of the main unit 4</p> <p style="padding-left: 20px;">Rear of the main unit 5</p> <p style="padding-left: 20px;">OPERATION PANEL 6</p> <p>Basic operation 7</p> <p style="padding-left: 20px;">From box opening to installation 7</p> <p style="padding-left: 20px;">Setting communication conditions [INTERFACE] 8</p> <p style="padding-left: 20px;">Operation modes 9</p> <p style="padding-left: 20px;">Attaching a tool 10</p> <p style="padding-left: 20px;">Attaching ball-point pen on the market 10</p> <p style="padding-left: 20px;">Loading a sheet of media 11</p> <p style="padding-left: 20px;">Tool conditions SETTING 14</p> <p style="padding-left: 20px;">Setting an origin 15</p> <p style="padding-left: 20px;">Test cutting 16</p> <p style="padding-left: 20px;">Starting cutting (plotting) 17</p> <p>Operation of keys corresponding to the functions 18</p> <p>Listing of functions 20</p>	<p>Before taking a phenomenon as a trouble 27</p> <p style="padding-left: 20px;">Troubles for which error messages are given on the LCD 28</p> <p style="padding-left: 20px;">Displays under the remote mode 29</p> <p>Adjusting the Blade tip and the brade of cutter 30</p> <p style="padding-left: 20px;">Replacing the cutter blade 30</p> <p style="padding-left: 20px;">Adjusting the blade tip of the cutter 30</p> <p>Specifications of the main unit 31</p> <p>Option 31</p>
---	---

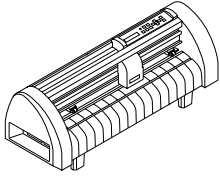
Checking the accessories

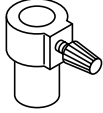
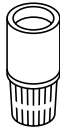
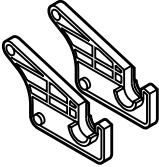
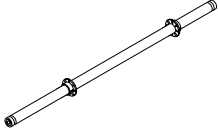
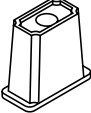
The articles illustrated below are supplied with your device as accessories. Check them up for correct quantities and appearance. If you should find any fault, please contact your distributor.

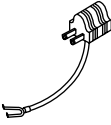
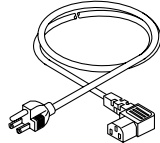
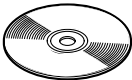
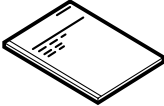
				
Main unit	Cutter holder 1piece	Water-ink ball-point pen 1piece	Pen adapter, 1 piece	Cap, 1 piece
				
Roll stay 2 piece.	Roll bar 1piece	Leg 4 piece	Screw 8piece (for roll hanger mounting/for legs)	L shaped wrench, 1 piece
				
Adapter (Only 100V)	Power cable	FineCut	Operation Manual	

Configuration of the main unit

Name of each part of the equipment and their functions will be explained. Try to memorize the names as quickly as possible and master their usage.

Front of the main unit

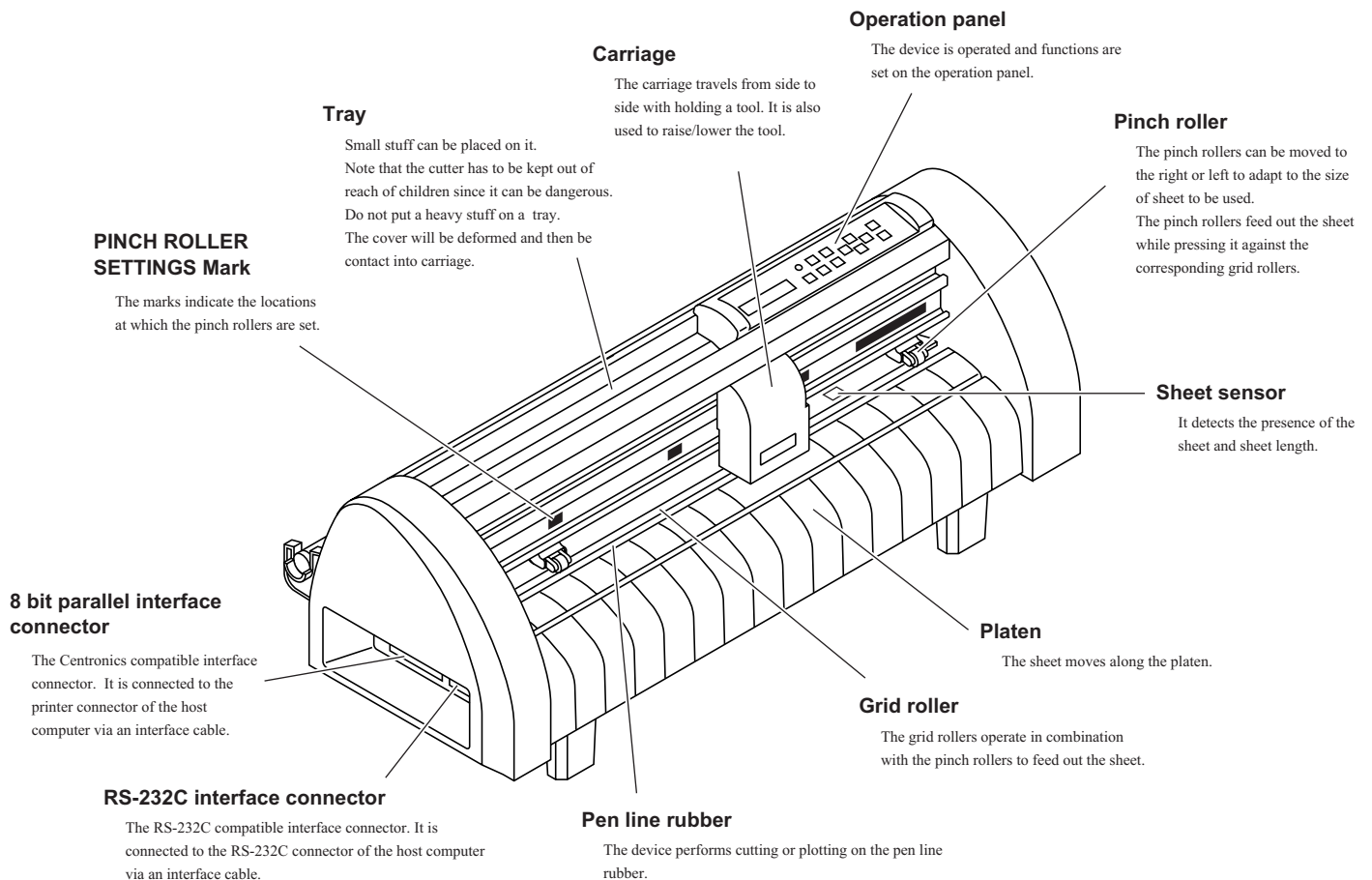

Rear of the main unit

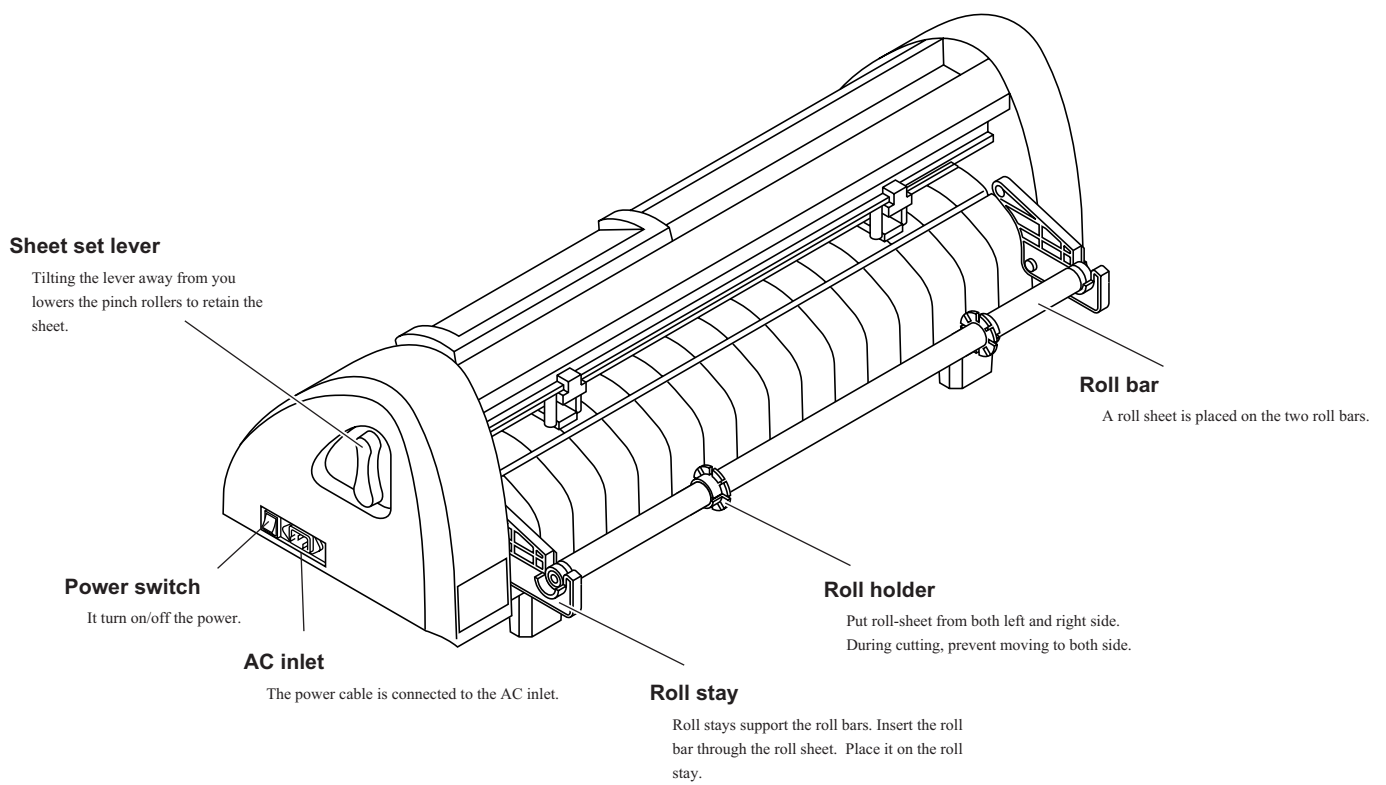

OPERATION PANEL

Configuration of the operation panel is as shown below.

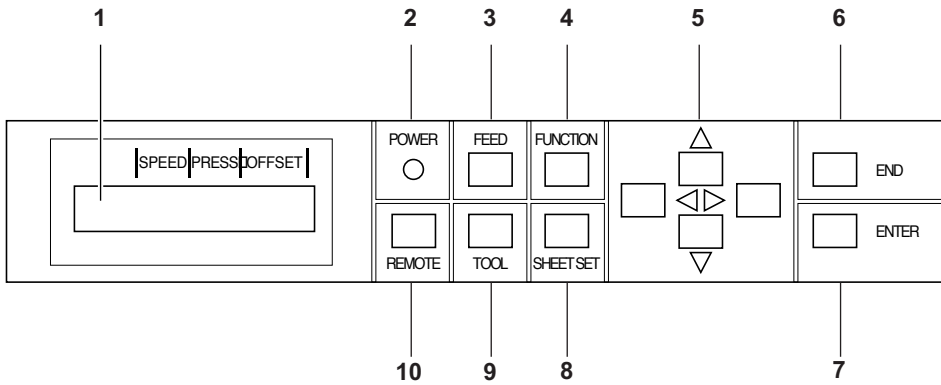

1. Display panel

The display panel indicates tool conditions such as speed, pressure and offset, tool coordinates, functions and error messages.

2. POWER lamp

It lights up when the power to the device is turned on.

3. FEED Feed key

This key is used to execute the sheet feeding.

4. FUNCTION Function key

This key is used to specify the function.

5. < > ^ v Jog key

These arrow keys are used to shift the carriage or sheet in the corresponding direction or change settings.

Refer to the explanation for each key in the table below.

Jog keys

The arrow keys are used as described in the table below.

	<	>	^	v
Before the detection of a sheet	Detects the sheet width. (In the case where a roll sheet is loaded onto the rear of the device)	Detects the width and top end of the sheet. (In the case where a cut sheet is loaded onto the rear of the device)	Detects the sheet width. (In the case where a roll sheet is loaded onto the front of the device)	Detects the width and top end of the sheet. (In the case where a cut sheet is loaded onto the front of the device)
After the detection of a sheet	Shifts the carriage to the left.	Shifts the carriage to the right.	Shifts the sheet away from you.	Moves the sheet toward you.
When selecting a function			Restores the last function.	Moves to the next function.
When selecting values			Change the last value.	Change the next value.

6. END End key

It is used to cancel the value is the last input.

7. ENTER Enter key

This key is used to enter the last input value for a setup item.

8. SHEET SET SHEET SET key

If this key is pressed when detecting the sheet size, the carriage can be moved manually.

9. TOOL Tool select key

This key is used to select a tool and establish tool conditions.

10. REMOTE Remote key

It is used to change over the operation mode between the REMOTE mode and LOCAL mode.

If this key is pressed while the device is in operation, the device will be brought to a halt.

To restart the device, repress the key.

From box opening to installation

1. Open the carton box and check accessory items.

Open the carton box, and make sure that all accessory items are included. Refer to "Confirmation of accessory items (See page 4)" regarding the accessory items. After confirmation, take out the main body and accessory items.

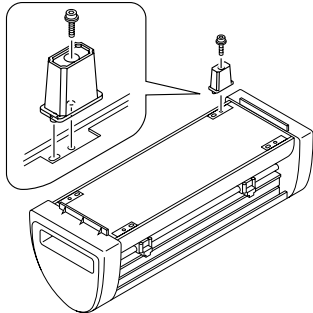

2. Attach the legs.

Place the main body up side down slowly. Mate the projection on the leg and the hole on the main body, and fix the leg firmly with screws using L shaped wrench. After attaching all the legs, turn the main body and place it normally on the floor, and check if it is stable.



• Precautions in installation

Sheet will move during cutting.

Therefore, install this equipment on a stable place.

3. Attach the roll stay.

Roll stay can be attached in the front or in the rear. Attach it to a position whichever is more convenient for working. Check the screw positions, then firmly tighten the screws using L shaped wrench. Attach both left and right sides similarly.

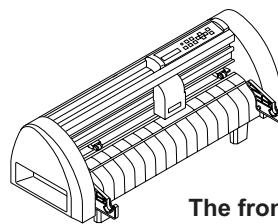
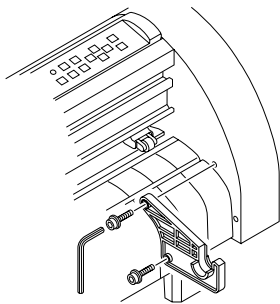

The front

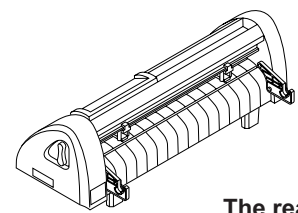

The rear

4. Connecting the interface cables.

When connecting the cables, turn off first the power to the device and that to the host computer which the power cable is to be connected.

The device comes with two different kinds of interfaces. Select either one that matches the host computer.

- RS-232C compatible interface
- 8 bit parallel interface (Centronics compatible)

Consult with the dealer or our sales office regarding the interface cable.

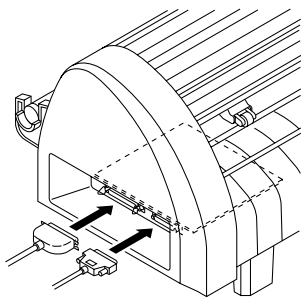

5. Connecting the power cables.

Connect the power cable to the receptacle of the following power specification.

- Voltage :AC100-240V +6%, -10%
- Frequency :50/60Hz ±1%



- If you use 2P inlet, connect a grounding adapter supplied with the unit to the power cable plug. Ground the green wire (ground wire) of the adapter. If the ground wire cannot be grounded, consult your nearest electrical service shop.

6. Turn on the host computer.

7. Turn the power of this equipment ON.



- Turn the power of this equipment ON after turning the power of the host computer ON. If this sequence is reversed, it may cause malfunction.

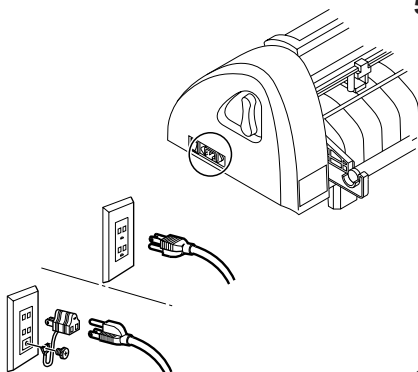

Setting communication conditions [INTERFACE]

In order to generate plotting correctly based on the data received from the host computer, communication interface conditions of your host computer and this equipment must be matched. 2 types of interface connectors as described below are used.

- RS-232C compatible interface
- 8 bit parallel interface (Centronics compatible)

If you are using RS-232C.

Set to the same setting values of interface conditions for both the host computer and this equipment. The underlined values shown below are the initial settings.

Setting value (Make a choice and input it)

Baud rate : 1200, 4800, 9600, 19200, 38400 (bps)
 Data bit : 7, 8 (bit)
 Parity : NON, EVEN, ODD
 Stop bit : 1, 2 (bit)
 Handshake : HARD, SOFT, X-PRM, SOFT
 Step size : 0.025, 0.01 (mm)



• If interface conditions are different between the computer and this equipment, data for plotting cannot be received correctly. Also, malfunction may be caused.

If you are using 8 bit interface.

In the case of 8 bit interface, baud rate ~ hand shake is not used. The underlined values shown below are the initial settings.

Setting value (Make a choice and input it)

Step size : 0.025, 0.01 (mm)
 Parallel I/F : NORMAL, BUFFER

Regarding the setting of parallel interface, refer to the following.

- NORMAL : The device receives data and performs cutting at a time.
 BUFFER : The device starts cutting under any of the following status.
- When the device receives 800 Kbytes data under the remote mode
 - When the device received certain data and has not received additional data for two seconds or more.

Guide for the case where the operating procedure of the 8-bit parallel interface is set to [BUFFER]:

- In the case where the host computer offers high-speed data transfer and it is desired to reduce the time of the host computer occupied by data transfer
- In the case where the device performs cutting intermittently since it receives data and performs cutting simultaneously ([NORMAL]). In the case where the performance of the device when conducting cutting according to the received data and that when conducting the plural sheets cutting independently from the host computer differ from each other.



• If you have changed the step size, the parallel interface will be effective after detecting the sheet.

1. CUT1 20 050 0.30
2. SET UP <ENT>
- 3.
4. INTERFACE <ent>
BAUD RATE :9600
5. BAUD RATE :19200
6. ⋮
7. DATA ADJ. :8 BITS
8. INTERFACE <ent>
9. SET UP <ENT>
10. CUT1 20 050 0.30

Press the REMOTE key switch to the Local mode.

Press the FUNCTION key several times.

Display is made as shown on the left.

Press the ENTER key to enter the function menu.

Press the FUNCTION key several times.

Display is made as shown on the left.

Press the ENTER key .

The baud rate currently being set is displayed.

Value can be changed by the jog key.

Press the ENTER key.

The value is registered, and the next setting item is displayed.

Step 6 and 7 are repeated.

Set the Parallel/F, then display 4) return.

Press the END key.

Then display 2) return.

Press the END key.

Then display 1) return.

Operation modes

The device operates under three different operation modes as shown below.

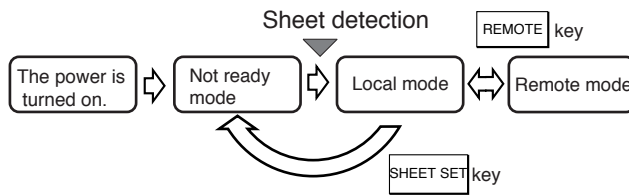

Not-ready mode

When the power is turned on, the device enters the not-ready mode and stays there until a sheet of media is detected. The keys other than the **REMOTE**, **FEED** and **SHEET SET** keys are effective.

Example of display

ROLL <R> LEAF

****NO SHEET****

The function to enable operations of the jog keys or plotter is not effective. (Such as in the case of executing test cutting or sample cutting) If you executed any of the aforementioned disabled function, the following message will appear on the LCD.

ERR30 OPERATION

Local mode

The device enters the local mode after the sheet detection.

Normally, tool conditions appear on the display panel. Under the local mode, all keys are effective to enable setups.

The device is able to receive data sent from the host computer, however, it will not perform cutting (plotting).

Example of display

CUT1 20 040 0.30

Remote mode

The device performs cutting under this mode.

The **REMOTE** key and **REMOTE** keys are effective.

If you press the **REMOTE** key during cutting, the device will be put on hold. Another press on the same key will allow the device to resume cutting.

If you press the **ENTER** key while the device is put on hold, the hold function that corrects the sheet that has slipped out of position.

Example of display

CUT1 ** REMOTE **

Attaching a tool

The below-stated tools can be used with the device.

- Cutter
- Ball-point pen on the market. (8-9mm diameter)
- Ball-point pen for plotter. (separately sold)

Refer to "Adjusting the blade tip and the blade of cutter (--->P.29) for the cutter blade adjustment and blade replacement.

1. Put a cutter in the tool holder.

Fitting the collar of the tool in the slit on the tool holder, put the tool in the holder.

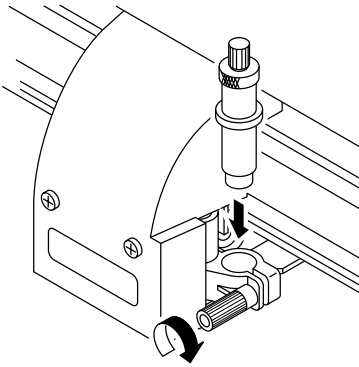

2. Turn the knob of the tool holder clock-wise until the cutter is secured.



CAUTION

- Be sure to securely fix the tool. If not, accurate and high-quality cutting results will not be obtained.
- Do not keep the screw of the tool holder tightened without a tool inside. If done, the tool holder will deform and it will be difficult to insert the tool.

Attaching ball-point pen on the market



CAUTION

- As for the ball-point pen on the market, use the ones with 8-9mm diameter. Picture quality may vary depending on the pen used.

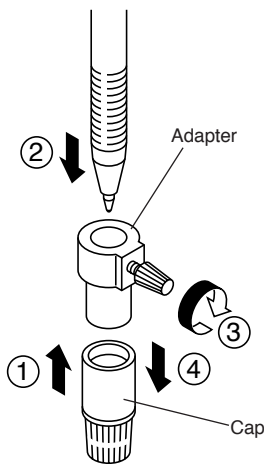

1. Put the cap on the pen adapter.

2. Insert the pen into the pen adapter.

Insert the pen all the way until the pen tip hits the cap.

3. Fix the pen tip.

Now, tighten the fixing screw clock-wise.



CAUTION

- Be careful not to over tighten the fixing screw of the pen adapter. If tightened too much, ball-point pen may crack.

4. Remove the cap.

5. Insert the pen adapter with the pen into the tool.



CAUTION

- Set the adapter in a way that the fixing screw will not hinder operation.

6. Turn the knob of the tool holder clock-wise to fix the tool.

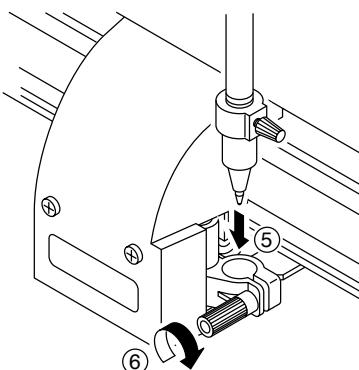

Loading a sheet of media

Loading a sheet of media

Either a leaf sheet or a roll sheet can be loaded on the device. The pinch rollers and grid rollers hold the sheet in position. Specify the location of the pinch rollers to match the sheet to be used.

The table given shows the width of sheet that can be loaded on the device and the maximum cutting area of the device.

	Sheet width	
	mm	inch
Leaf	50 to 711 mm	24
Roll sheet	50 to 670 mm	

Maximum cutting area

The area in which cutting can be made is as described below.

	Maximum cutting area	
	Setting value for origin point switching: "center"	Setting value for origin point switching: "right bottom"
Normal	586 mm x 3 m	586 mm x 51 m
Expand	606 mm x 3 m	606 mm x 51 m

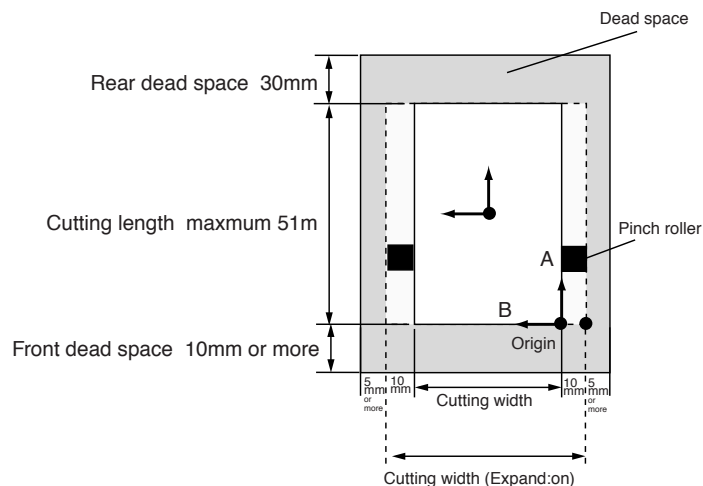

Pinch rollers and grid rollers

Move the pinch rollers to appropriate grid rollers in accordance with the width of sheet to be loaded on the device. Change the location of the pinch rollers using the marks as a guide.



- Be sure to raise the pinch rollers whenever the machine is not in operation.
 - Never set the pinch rollers with deviated or separated from the grid rollers.
- CAUTION** If the pinch rollers are not properly placed, they may fail to retain the sheet during cutting.

Travel range of pinch rollers



- When you use the narrow sheet, place the sheet over the sheet sensor. If the sheet is out of the sheet sensor, the sheet will not be detected.
- Keep away from the rotating grid rollers. Injury could result if the rotating grid rollers are contacted since the rotating grid rollers can shave the skin or the rotating grid rollers and platen can catch fingers between them.

Loading a roll sheet

When roll sheet is used on this equipment, attach a roll stay. Regarding the attachment of roll stay, refer to "From box opening to installation. (--->P.7)". If roll paper is attached for the first time, start from step 2, and when replacing the roll sheet, start from step 1.

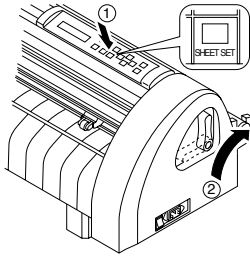

1. Press **SHEET SET** key, and raise the sheet set lever.

Replace the roll sheet. LCD display will be indicating the image as shown on the right. When setting the sheet, slide the carriage by hand lightly so that the carriage will not get in the way.

ROLL <R> LEAF

ROLL ^ F V LEAF

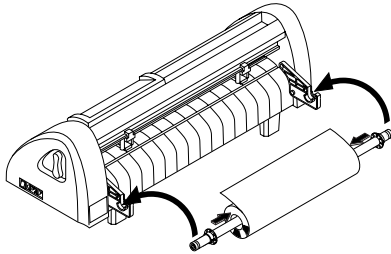

2. Set the roll sheet.

Insert the roll bar through the roll sheet. Place the roll sheet between the two roll holders. Place it on the roll stay. Adjust the position of the roll holders to determine the position of the roll sheet. These roll holders prevent the roll sheet from moving from side to side during cutting. Stretch the sheet and insert it through the platen.

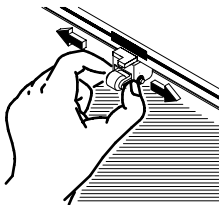

3. Move the pinch roller to match the sheet width.



CAUTION

- Set the pinch roller at a position at least 5mm inside from the sheet edge. If it is positioned less than 5mm, it may cause the sheet to get out of its place during sheet feed.
- Set the pinch roller to align with " ■ " mark of the grid roller.
- Roll stay can be set either in the front or rear of the main body. (--->P.7)

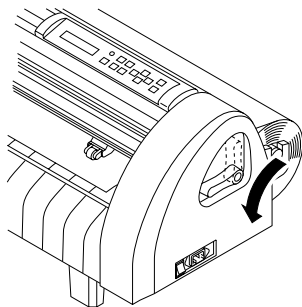

4. Lower the sheet set lever.

Displays the detected size of the roll sheet.

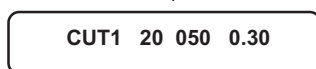
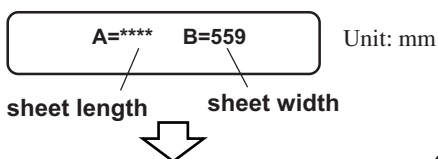

Displays the currently specified tool conditions.

5. Press **^** key when the roll sheet is set from the front or press **<** key when the roll sheet is set from the rear to select "ROLL".

Initial operation will be made after detecting the sheet.

Display panel will indicate the image as shown on the left.



- You can finish detecting the sheet, when you press **END** key while detecting the sheet.

6. Press **FEED** key.

Use **^** key or **v** key to set the length to be used. Set the length to be used based on the length in the feed direction of the cut data. After setting, press **ENTER** key. Then, the sheet will be fed automatically.

SHEET FEED :1.0m



CAUTION

- Before using the roll sheet, pull out the sheet in the length equivalent to the length used in advance to leave a margin. By feeding the sheet out, you can make sure that there is no sheet shifting in advance.
- Maximum length for setting is 51 m (167 feet).

Loading a leaf sheet

When setting a leaf sheet for the first time, start from step 2, and when replacing the sheet, start from step 1.

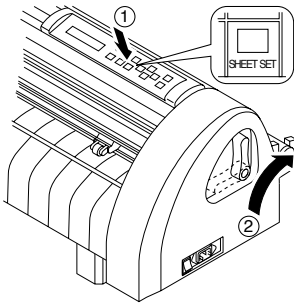

1. Press **SHEET SET** key, and raise the sheet set lever. Replace the leaf sheet.

Replace a leaf sheet. LCD display will be indicating the image as shown on the right. When setting the sheet, slide the carriage by hand lightly so that the carriage will not get in the way.

****NO SHEET****

ROLL <R> LEAF

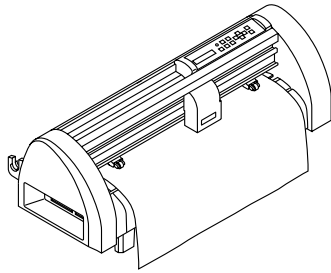

2. Insert the sheet through the platen.

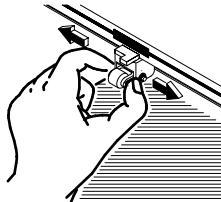

3. Move the pinch roller to match the sheet width.



CAUTION

- Set the pinch roller at a position at least 5mm inside from the sheet edge. If it is positioned less than 5mm, it may cause the sheet to get out of its place during sheet feed.
- Set the pinch roller to align with "■" mark of the grid roller.

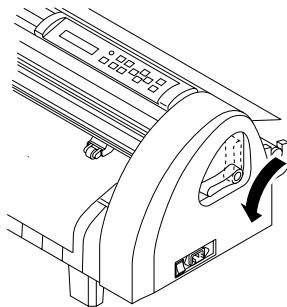

4. Lower the sheet set lever.

Displays the detected size of the leaf sheet.

A=654 B=459

Unit: mm

sheet length

sheet width

CUT1 20 050 0.30

Displays the currently specified tool conditions.

5. Press **>** key when origin point is set to be on the front side of the sheet or press **∇** key when origin point is set to be in the back side of the sheet to select "LEAF."

The device performs the sheet detection, then performs a dummy cutting.

Display panel will indicate the image as shown below.



CAUTION

- The device is not able to detect a leaf sheet of which length is 3 m or more.



- You can finish detecting the sheet, when you press **END** key while detecting the sheet.



CAUTION

Precautions for sheet replacement

After replacing the sheet, make sure to pull down the sheet lever toward you. If the sheet lever is not down, sheet detection cannot be made as the pinch roller cannot hold the sheet. Make sure that the sheet lever is down.

Tool conditions SETTING

Three different tool conditions are to be set such as cutting conditions and plotting conditions.

Specify "SPEED", "PRESS" and "OFFSET" settings that suit the tool to be used.

To set tool conditions, press the **TOOL** key under the local mode, select tool condition with **ENTER** key and input settings.

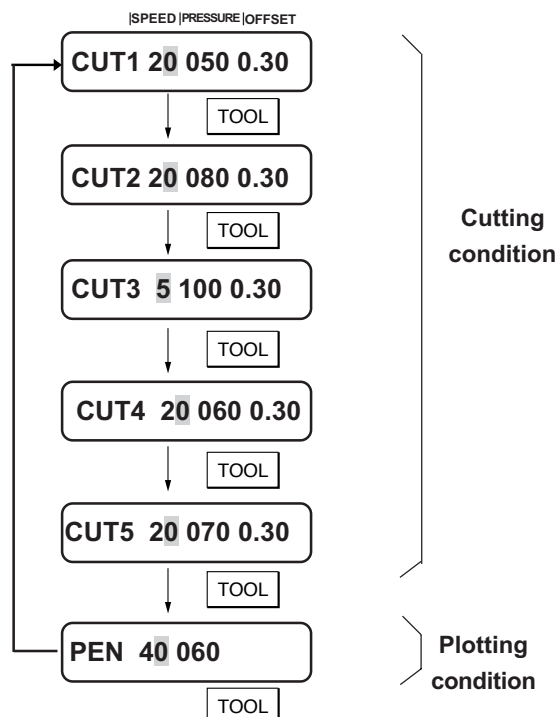

• Cutting conditions

Enter tool conditions for the operation using a cutter. Five kinds of cutting conditions (CUT1, CUT2, CUT3, CUT4 and CUT5) can be entered.

This means these conditions can be entered separately according to the cutter to be used. Once cutting conditions are specified, the cutter will perform a dummy cutting (to adjust the blade direction). Dummy cutting operation is intended to determine the blade direction before cutting.

• Plotting conditions

Enter conditions for the operation using a pen.

• Contents of setting value

- **SPEED** : Cutting (plotting) speed. Set to the appropriate speed.
- **PRESS** : This is the force to press the cutter or the pen. Set to an appropriate value depending on the sheet material or pen type. If the setting is not appropriate, the following symptom may appear.
 - Sheet is turned over during plotting.
 - Lifetime to blade is shortened.
 - Main body is damaged, etc.
- **OFFSET**: This is the distance the cutter blade is shifting from the holder center. Change the offset value depending of the sheet thickness or the type of blade. Change the offset value depending on the sheet thickness or the type of blade. If the setting is not appropriate, the following symptom may appear.
 - If the offset amount is increased, square-shaped characters will be cut/plotted.
 - If it is decreased, round-edged characters will be finished.

•Setting value

Tool conditions	Cut conditions	Plotting conditions
SPEED	1 to 10 cm/s (1 cm/s step) 15, 20, 25, 30, 35, 40, 50(5cm/s step)	1 to 10 cm/s (1 cm/s step) 15, 20, 25, 30, 35, 40, 50(5cm/s step)
PRESS	10 to 20 g (2 g step) 20 to 100 g (5 g step) 100 to 300 g (10 g step)	10 to 20 g (2 g step) 20 to 100 g (5 g step) 100 to 150g(10 g step)
OFFSET	0.00 to 1.00 mm (0.05 mm step)	



CAUTION

- For the cutter supplied with the unit, set the offset to 0.30 mm.
- In the case where the pressure is smaller than 20 g, set the speed using a 10 cm/sec as a guide. If the speed is higher than the appropriate value, the tool can rise to produce blurred characters or a portion that remains uncut.

Reference values of conditions for plotting

Before actually cutting a sheet of media, conduct test plotting to check the quality of finished characters and marks.

Type of pen	SPEED	PRESSURE
Water-ink ball-point pen (0.3 mm)	40 cm/s	60 g
Oil-based ink ball-point pen	40 cm/s	150 g

1. CUT1 20 050 0.30

Put the machine into local mode.

2. CUT1 20 050 0.30

Press the **TOOL** key.

The cursor will flash on SPEED. When the **TOOL** key is pressed again, the tool conditions change.

3. CUT1 10 050 0.30

By pressing the **▲** or **▼** key, the SPEED can be changed.

4. CUT1 10 050 0.30

Press the **ENTER** key, the SPEED is registered and the cursor moves to PRESS.

If the **END** key is pressed without pressing the **ENTER** key, display 1) returns without the SPEED value begin registered.

5. CUT1 10 120 0.30

By pressing the **▲** or **▼** key, the PRESS can be changed.

6. CUT1 10 120 0.30

Press the **ENTER** key, the PRESS is registered and the cursor moves to OFFSET.

7. CUT1 10 120 0.20

By pressing the **▲** or **▼** key, the OFFSET can be changed.

8. CUT1 10 120 0.20

Press the **ENTER** key, the PRESS is registered

Tool conditions are registered, and blade orientation is executed.

Setting an origin



- After the cutting is completed, make sure to set the origin point to a different position before cutting again. If a new origin point is not set, the next data will also be cut (plotted) at the same origin point as the previously cut data.

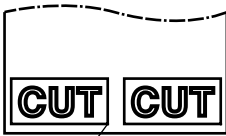

New origin

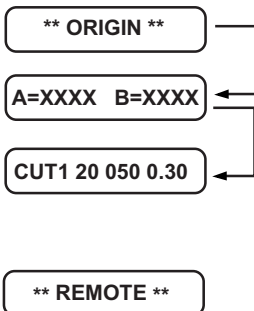

1. Move the head to a point that is specified as an origin.

The origin is a reference point of data to be cut (plotted).

Move the tool tip to an origin point desired to be set by the jog operation.

- ▶**: Moves the head to the right.
- ◀**: Moves the head to the left.
- ▲**: Moves the sheet away from you.
- ▼**: Moves the sheet toward you.



- Every time you press the **TOOL** key, the tool will go up and come down alternately. This helps you to set an origin at a correct position with accuracy.

2. Press the **ENTER** key to enter the origin.

After the effective cutting area appears on the LCD, tool conditions will appear there.

3. After the origin point setting, press **REMOTE** key.

Then the display will change and the system will be in the remote mode. After that, data will be transmitted from the host computer.

Test cutting

Before starting to cut.

Before starting to cut, check the following points.

- **Tool is attached correctly. Screw of the tool holder is firmly tightened.**
- **There is a sheet, and sheet lever is pulled down toward you. Pinch roller is down.**
- **Origin point setting (--->P.15).**
- **Communication interface setting (--->P.8).**

First, test cut to see the result of cutting. Repeat setting of cut conditions (--->P.14) and test cut until optimum cutting conditions are found. There are two patterns in test cutting.

- Test cutting square cut
- Sample cut

Test cutting [SQUARE]

In the case where you have changed the type of sheet or tool and cutting conditions have been changed correspondingly, the test cutting function is used to execute test cutting to check that the cutting conditions such as SPEED, PRESS and OFFSET are appropriate.

In the test cutting, the device cuts two different types of squares. (Refer to the figure on the right.)

Check the result of square cutting according to the following steps.

1. When test cutting is finished, peel 1) off.
2. Peel 2) off.



- If the cutter mark is slightly made on the sheet base paper, it can be said that the speed and cutter pressure are optimally set.
- Change the settings for cutting conditions, if necessary, depending on how the squares are cut.
- The device executes the [SQUARE] at the current tool location.

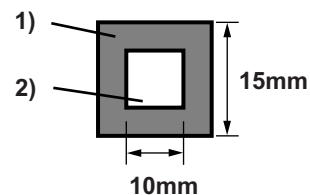

Sample cut [SAMPLE CUT]

In the case where the device fails to cut data correctly or the end point of cutting of a character fails to meet the starting point, the cause of such a fault can be checked up by cutting the characters "Cut."

Cut



- **In the case where the device is able to normally cut the characters "Cut" but fails to cut other data:
The host computer is faulty.**
- **In the case where the device fails to cut both the characters "Cut" and other data:
The device may be faulty. Contact your distributor.**

Starting cutting (plotting)

Start cutting after installation of tool and sheet, and tool condition setting.

CUT1 ** REMOTE **

CUT1 * 1356 K B *



• When selecting the cutter

CUT1 ** REMOTE **

• When selecting the pen

PEN ** REMOTE **

1. After the set of the origin, press the **REMOTE** key.

The display on the LCD will change over to the remote mode.

2. Send data from the host computer to the device.

Once the device receives data, the device will give the remaining amount of data while performing cutting.

When the device completes cutting, the display shown on the left will appear on the LCD.

Putting the cutting (plotting) on hold

To temporarily stop the device during cutting, press the **REMOTE** key once. Another press on the same key will allow the device to resume cutting.



- If any function that initiates some action or any operation that can affect the command coordinate system is executed during a pause period, the error message shown below will appear on the LCD.

ERR34 DAT REMAIN

In the event that the error message appears on the LCD, press the **REMOTE** key to cut the remaining portion of data or execute data clear.



CAUTION

- In case the sheet is off from the pinch roller while cutting, immediately turn off the power switch.
- When the sheet is almost out of the pinch roller, press **REMOTE** key to halt the machine and execute the **DATA CLEAR** (or turn off the power switch) Then press **SHIFT SET** key to reset the sheet. (--->P.12,13)

Operation of keys corresponding to the functions

In the function menu flow chart section, major functions of basic operation and applied functions are explained with a * mark attached. Regarding the * marked function, see the referenced page on the table of functional explanations. Furthermore, see "Listing of functions (--->P.20~)" for each function.

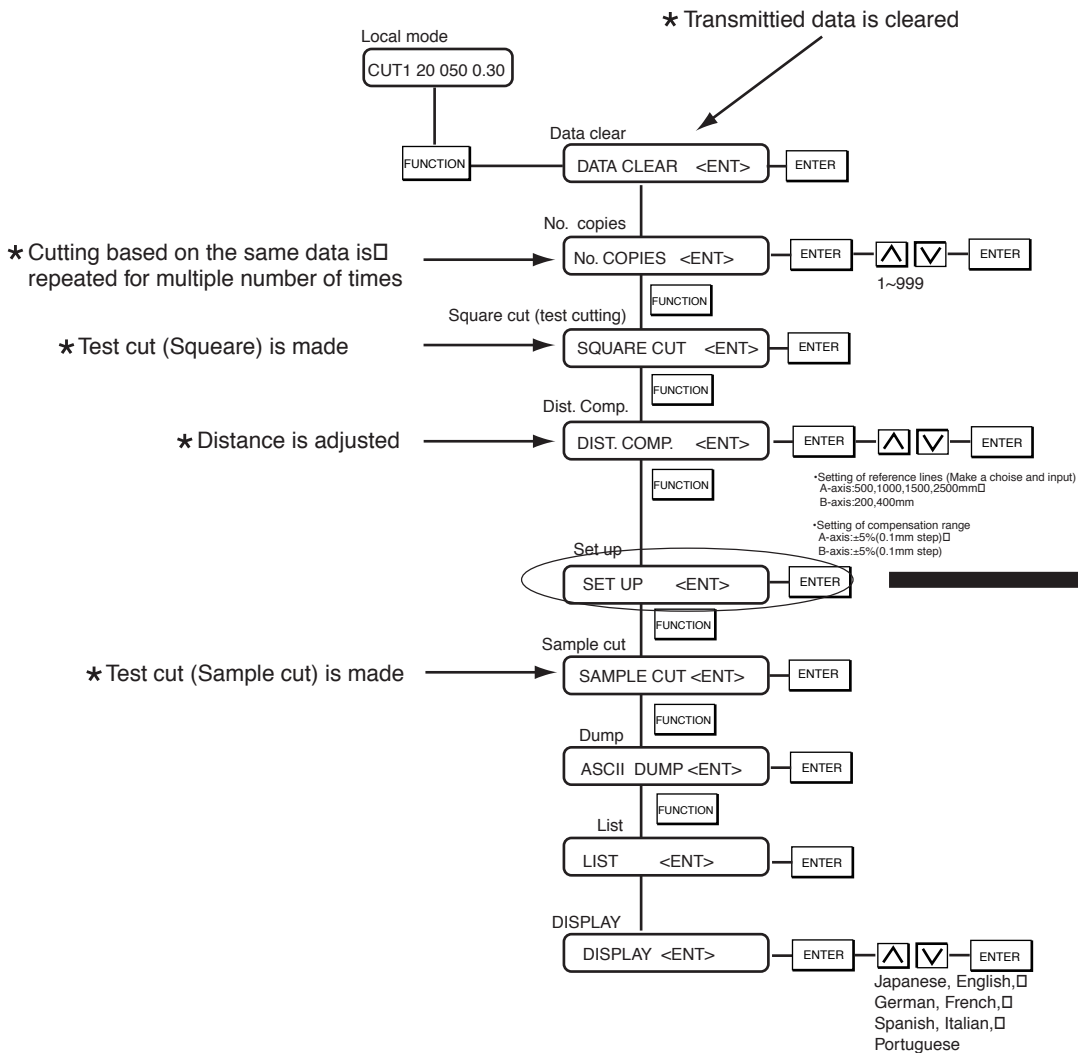

•What is "setting function"? Setting function is used for setting to match the specifications on the host computer side, or for settings related to the plotter operation. The content of the setting will remain stored even if the power is shut off.

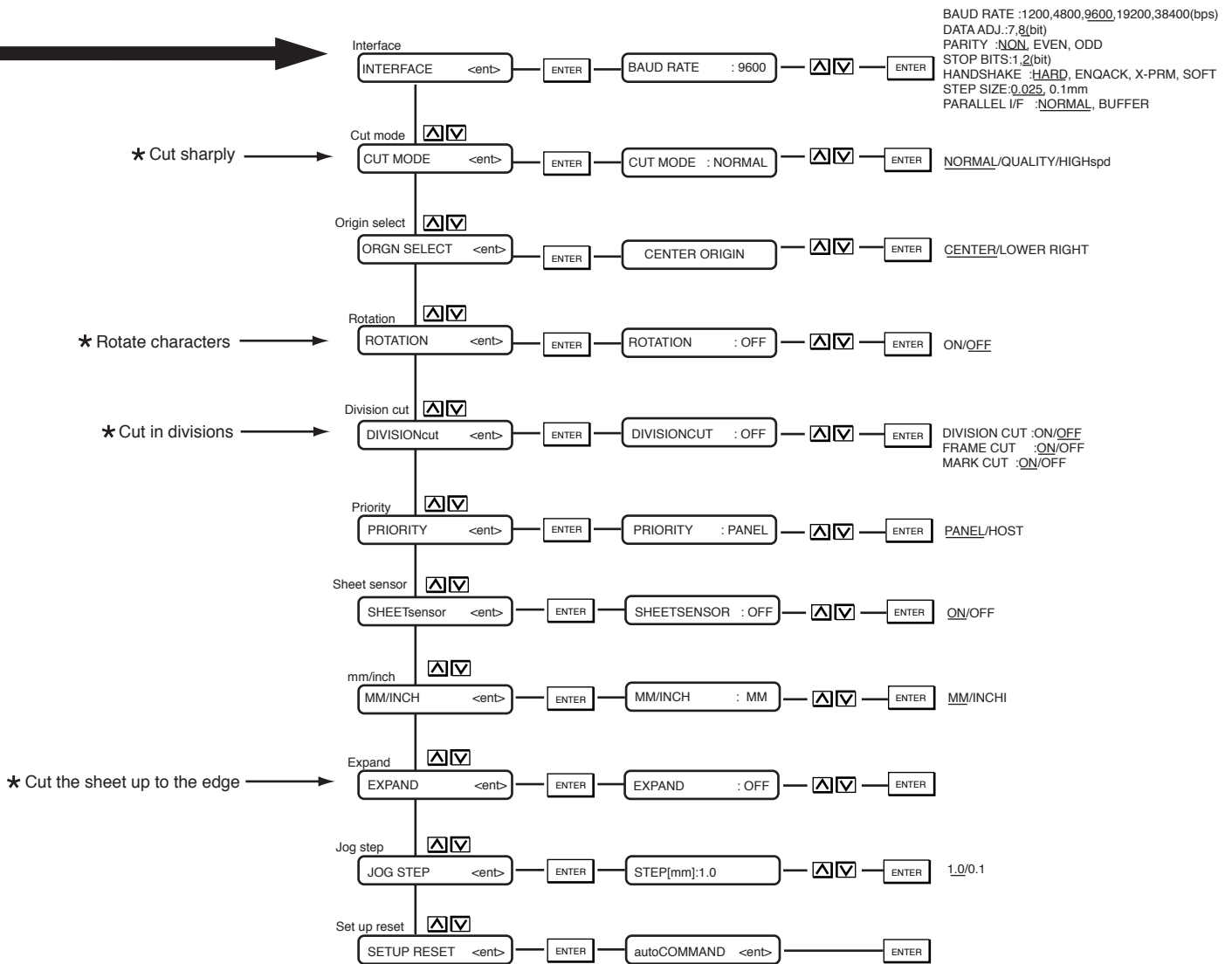

•Underlined values indicate initial settings.

Listing of functions

The device is provided with the following functions. As for the items with a * mark, refer to the description following the table.

Functions invoked with the jog keys (arrow keys)

The jog function is used to move the top end of a tool to a given location to set coordinates of the plotter.

Item	Description of function	Reference page
Origin select	The origin is a reference point of data to be cut (plotted). To start cutting (plotting), be sure to specify an origin in prior.	15
Cutting area setting *	An area in which the device performs cutting (plotting) is specified. The area that has a diagonal line extending from the origin and a given the point is the effective cutting area. If you tilt the sheet set lever away from you, the cut area specified will be cleared.	22
Axis alignment *	Aligns the axis of the sheet to be used with that of the device.	21

Functions invoked with specific keys

Item	Description of function	Reference page
Tool select	Sets a tool to be used to a cutter or pen.	14
Sheet feed	Feeds the sheet by the amount to be used. In the case where a roll sheet is used or a long-dimension data is to be cut, the sheet has to be fed by the length to be used to provide an allowance. In addition, displacement of the sheet can be checked by feeding the sheet. Enter the length to be fed by sheet feed using a jog key.	12
Sheet set	Sheet is detected again at the time of sheet replacement.	12,13

Functions

Item	Description of function	Reference page	
Data clear *	Clears data being cut.	18,21	
No. copies *	Performs cutting according to the received data on two or more sheets.	18,22	
Square cut *	Performs cutting of a square to verify that cutting conditions are appropriate.	16,18	
Distance compensation *	Compensate an error in cutting length.	19,23,24	
SET UP	INTERFACE	Establishes communication conditions in accordance with the host computer in the case where interface is used.	8
	CUT MODE *	Specifies cutting quality. Change cutting quality when smooth curve or fine finish is desired.	19,21
	ORIGIN SELECT	Establishes an origin in accordance with the command specification of application software used.	19
	ROTATION *	Specifies the location of origin and direction of coordinate axis. 4 types of rotation based on the coordinate system and moving of the origin point can be made by combination.	19,21
	DIVISION CUT *	Cuts data that exceeds the sheet width with divided appropriately.	19,25
	PROPRITY	This function is used to specify the setting that is given priority in terms of the following tool setting values; either the setting established on the device or that established on the host computer is given priority.	19
	SHEET SENSOR	Turns off the sheet sensor function. The sheet sensor detects the presence/absence of a sheet and the sheet length. Two sheet sensors are mounted on the platen. In the case where any of the following types of sheet is used, the sheet sensors will not be able to detect it to give the error message shown below. •Transparent sheet that does not reflect the light coming from the sheet sensor. •The sheet of which wrong side is black that does not reflect the light coming from the sheet sensor. In this case, cutting is enabled by setting the [SHEET SENSOR] function contained in the SET UP of FUNCTION to OFF. **NO SHEET**	19
	MM/INCH	Changes over the unit of length to be displayed. Unit for jog operation, and unit for sheet size display and distance correction can be changed.	19
	EXPAND *	When cutting is to be made up to the edge of a sheet, the use of EXPAND function will enable plotting over the pinch roller, thus maximum plotting width can be expanded.	19,21
	JOG STEP	Specifies an amount of travel corresponding to a press on a jog key (arrow key).	6
SETUP RESET	Initializes the current tool setting.	19	
Sample cut	Performs cutting of characters "Cut" to determine whether or not the device is faulty.	16,18	
Dump execution	Plots data sent from the host computers in the ASCII data format. To execute the dump, be sure to use a pen as the tool.	18	
List	Plots tool conditions or function setting conditions. To execute the list, be sure to use a pen as the tool.	18	
Display	Changes over the language to be displayed on the LCD.	18	

*Data clear [DATA CLEAR]

The device terminates cutting of the current data, and starts cutting of new data.

If you want to stop cutting of the current data before the device completes it, you have to clear the data received.



- **After the execution of data clear, the received data will remain in the receiver buffer. It is, therefore, possible to cut (plot) the data in repetition using the plural sheet cutting function.**

Execute the data clear and set the device in the remote mode. When the device receives new data from the host computer, it will cut the new data.

*Change-over of cut mode [CUT MODE]

When smooth curve or fine finish is desired, this function is used to specify the cutting quality.

• Setting value (Make a choice and input it)

- QUALITY*1 : The device conducts cutting giving priority to the cutting quality.
NORMAL : The device conducts cutting normally.
HIGHspd*2 : The device conducts cutting quickly.

*1: Select the "QUALITY" in the following cases:

- Where a character of which size is 10 mm or less is to be cut
- Where a picture pattern or character that have many sharp curves is to be cut
- Where fine cutting is to be performed

*2: It should be noted, however, that a pattern with a rugged edges may be finished in the case where the data sent from the host computer is excessively minute. It is recommended in such a case to select the "HIGHspd" for smoother finish.

*Cutting up to the edge of a sheet. [EXPAND]

When cutting is to be made up to the edge of a sheet, the use of EXPAND function will enable plotting over the pinch roller.

Thus maximum plotting width can be expanded. While inside of the pinch roller is the normal plotting area, expansion of 10 mm per side, total 20 mm, is possible.

• Setting value (Entering of choice.)

ON: Maximum plotting width is expanded.

OFF: Maximum plotting width is not expanded.



- **When EXPAND is selected, dummy cut function for blade orientation adjustment cannot be used. In order to adjust blade orientation prior to cutting, make test cutting "test cut [square]".**
- **Preset value will be effective after sheet detection.**
- **Footprint by pinch roller and grid roller will remain.**

*Rotation [ROTATION]

This function is used to specify the location of origin and direction of the axis of coordinates according to the application software to be used. After the sheet detection, Carriage will stop at the origin point on either the left edge or the right edge, depending on the preset value.

• Setting value (Make a choice and input it)

ON : The device rotates the coordinate axis and relocates the origin at a time.

OFF : The device does not perform rotation of the coordinate axis.

The device has four different axis of coordinates according to how the sheet loading direction and the angle of rotation of the coordinate axis determined by the rotating function are combined.

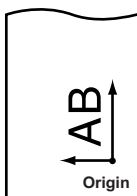

Rotating function: OFF

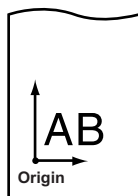

Rotating function: ON

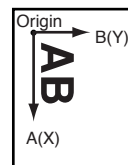

The sheet is loaded on the front of the device.

Rotation: OFF

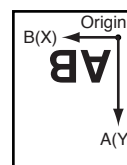

The sheet is loaded on the front of the device.

Rotation: ON

*Cutting area

An area in which the device performs cutting is specified. The area that has a diagonal line extending from the origin and a given UL (upper left) point is the effective cutting area. If you tilt the sheet set lever toward you, the cut area specified will be cleared.

CAUTION

- Be sure to specify an upper left point in the area that is located in the normal direction from the origin.
- Be sure to set an origin in the cutting area. If you establish an origin outside the cutting area, an operation error will result.

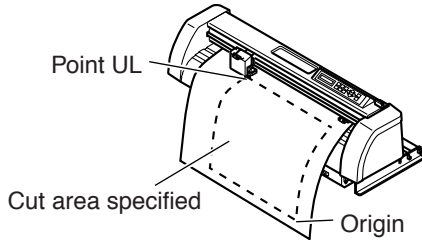

- When the cut area is desired to be nullified. Press **SHEET SET** key, and set the sheet once again. (--->See pages 12 and 13)

1. **CUT1 20 050 0.30**
2. **0.0 0.0**
- 3.
4. **0.0 0.0 ↖**
0.0 258.0 ↖
5. ****CUT AREA****

Press **REMOTE** key to switch to local mode.

Press either one of the **↩** **➤** **⬆** **⬇** keys.

Press **FEED** key.

Set the area to be cut.

Set the cut area on the UL point on the diagonal line using **↩** **➤** **⬆** **⬇** keys.

Press **ENTER** key.

Now, the cut area is registered. The system will return to the local mode.

*Axis alignment

When cutting a contour of a printed matter of which positioning is made, axis of the preset sheet and axis of this machine will be aligned. Axis inclination (θ) is corrected by the origin and the correction point which is provided by this function.

CAUTION

- θ range is $-45^\circ \leq \theta \leq 45^\circ$. Outside of this range will be treated as operational error.

- When the Axis inclination (θ) is desired to be nullified. Press **SHEET SET** key, and set the sheet once again. (--->See pages 12 and 13)

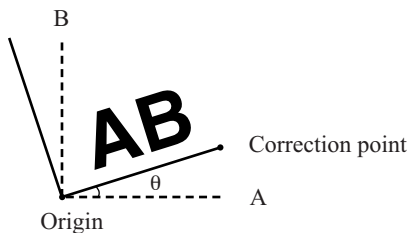

- 1.
2. **100.0 235.4p**
100.0 150.0p
3. ****COMP. X, Y****
4. **CUT1 20 050 0.30**

Set the Origin.

Press either one of the **↩** **➤** **⬆** **⬇** keys.

Press **FUNCTION** key. Then "p" will be displayed at the right edge.

Move to the correction point.

Press **ENTER** key.

Correction point is stored, and the machine will go to local mode.

*No. of copies [No. COPIES]

This function is used to perform cutting of the received data on two or more sheets.

The device stores the received data in the receiver buffer to enable cutting in repetition on as many as 999 sheets.

When the device receives new data, the data stored in the receiver buffer will be updated.

• Setting value (input of numeric data)

1 to 999 (sheets)



- If No. COPIES is executed immediately after cutting under the remote mode, the data will be cut overlapped. To avoid this trouble, reset an origin.
- To send plural pieces of data from the host computer to the device, the data has to be sent while providing an interval of 10 seconds or more after cutting. If two pieces of data are sent from the host computer to the device within 10 seconds, the two pieces of data will be subjected to the plural sheet cutting unless the origin is reset.
- The device cuts division cut data by the specified number of sheets without dividing the data.
- While performing No. COPIES function, the device will not receive the data from host computer.
- In the event that any error appears on the LCD, refer to page 28.

1. CUT1 20 050 0.30

2.

3.

4. No.COPIES <ENT>

No.COPIES : 1

5. No.COPIES : 10

6. * 1/ 10 COPY *



** REMOTE **

Send the data to be copied from the computer, and perform normal cutting.

Press the **REMOTE** key to switch the Local mode.

Set the origing at the location where copying is to be done.

Press the **FUNCTION** key several times, select the [No. COPY].

Press the **ENTER** key once; "1" flashes.

Use the **▲** or **▼** key to enter the number of copies (maximum 999).

Press the **ENTER** key, cutting starts.

"1/10" means "copy being cut/ total number of copies".

After cutting is completed, the machine goes into remote mode.

The locations of copies for second cutting and beyond are to be allocated according to the size of the original data. Lengthwise and widthwise interval between copies of the original data is 1 mm. After the completion of copying, the location of origin will be reset.

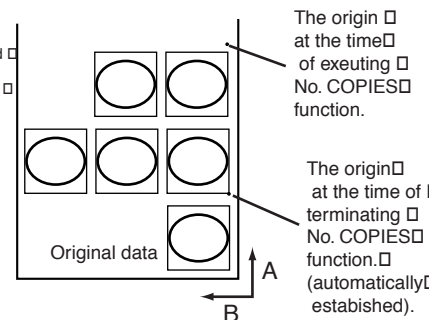

*Distance compensation [DIST. COMP]

If the data transmitted by the computer and the length of data actually plotted are compared, there may be some differences (when the sheet thickness is changed, in particular). Calculate the distance for correcting the difference, then set that correction. (See next page for the calculation method of correction value.)

1.

Press the key to select [DIST. COMP].

2.

The currently selected scale setting will appear on the LCD.

3.

The reference length (unit: mm) that was used in the previous correction will appear on the LCD.

If no distance compensation has been performed, the minimum reference length will appear on the LCD.



- The length display shown below means that the [DIST. COMP] was executed using the mark detecting function or the [DIST. COMP] was changed over to the [MM/INCH]. A press on the or key will enable the inputting of a numeric.

4.

Input a reference length.

Select the reference lengths (unit: mm) in directions A and B using the or key. Specify the reference length with the key.



- If you change the reference lengths in direction A and B, the distance correction value will be cleared.

5.

The device plots an adjustment pattern.



- If no sheet is placed on the device, or the sheet size is too small to plot a reference length, the device will not conduct plotting and proceed to the correction value inputting stage.

6.

Upon completion of plotting, the device will give the current compensation value on the LCD.

7.

Measure the ON line along A- and B-axis.

If any of the measurements of the ON lines differs from the corresponding reference value, input a compensation value. If the measurements are same with the corresponding reference values, terminate the function with key.

8.

Select the compensation values in A and B directions.

Select the compensation value using the or key and specify it with the key. After the completion of compensation, the device will enter the local mode.



- To reset the distance compensation function, input "0, 0" respectively to the compensation values for A- and B-axis.

Compensation value

Find compensation values referring to the description given below.

Compensation value = Measurement of the OFF line – Reference length input

Example)

Reference length input = 1000 mm

Measurement of the OFF line = 999.0 mm

$999.0 - 1000 = -1.0$ mm

As a result, the compensation value to be input will be “-1.0 mm.”

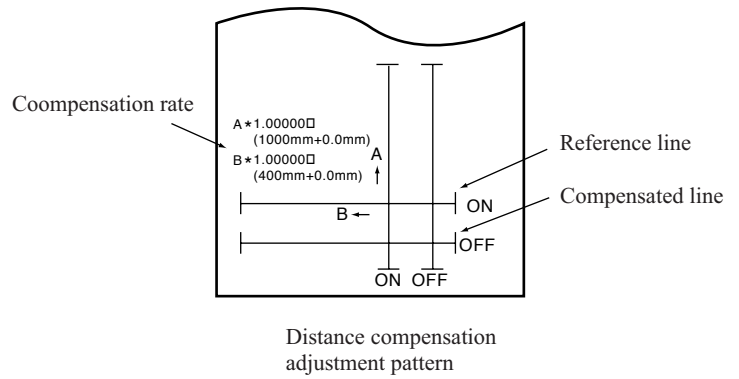

Settings of reference lines (Make a choice and input it)

• For "mm":

A-axis : 500, 1000, 1500, 2000, 2500 mm

B-axis : 200, 400 mm

• For "inch":

A-axis : 24, 36, 48, 60, 72, 96 inch

B-axis : 6, 12, 18

Settings of compensation range (numerical input)

• For "mm":

A-axis : ± 5 % (0.1 mm step)

B-axis : ± 5 % (0.1 mm step)

• For "inch":

A-axis : ± 1 inch

B-axis : ± 1 inch

*Division cut [DIVISION CUT]

In the case where the data on cutting exceeds the sheet width, the device is able to cut the data with divided appropriately. In the case where the rotating function is set to the ON state, the result will be as illustrated below.

• Setting value (Make a choice and input it)

DIVISION CUT : ON, OFF
 FRAME CUT : ON, OFF
 MARK CUT : ON, OFF

In the case of the frame cut or division cut margin, the device will perform cutting based on the size of data on cutting. If the host computer designates the frame cutting and sends data to the device, the frame will align with the adhesion allowance marks to facilitate adhesion.



CAUTION

- While the device is engaged in division cut, it will ignore other data sent from the host computer.
- The sheet has an adhesion allowance of 1 cm. It is, therefore, necessary that the effective cutting area shall be wider than 1 cm at all times.

In any of the following case, the device will cut neither the frame nor the division cut margin.

- Where the capacity of data is larger than the receiver buffer capacity
- Where the origin updating command is contained in the data on cutting
- Where the two-point correcting function is specified
- Where the width of effective cutting area is 1 cm or less
- Where the device cuts the test data stored in it the following display will appear on the LCD panel.

** END DIVISION **

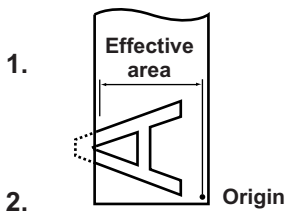

Set the [DIVISIONcut] to the ON state.

5.

Establish a new origin.

Move on the sheet using the jog key (arrow key) to establish an origin. If the sheet has no space for cutting, replace the sheet with a new one.

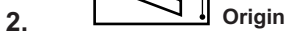

Send data from the host computer to the device.

If the data exceeds the cutting area, the display given on the left will appear on the LCD.

**OFF SCALE **

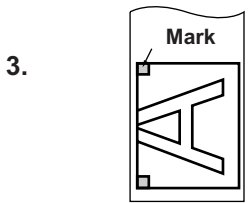

Upon completion of cutting, wait until the device cuts the frame and adhesion allowance mark.

6.

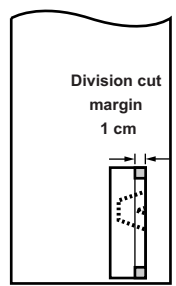

Press the REMOTE key to set the device in the remote mode.

Feed the sheet by the maximum sheet length required by data on cutting and start cutting. When the sheet is too short to feed, the error message below will be displayed.

** DIVISION ** XXs

The time required to cut the frame and the division cut margin will appear on the LCD panel.

ERR15 AUTO FEED

Change to a larger sheet according to step 5.

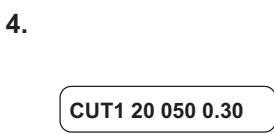

Upon completion of the frame cutting, the device will enter the local mode.

The display shown on the left will appear on the LCD panel.

7.

CUT1 20 050 0.30

Carry out steps 5 and 6 in repetition.

Repeat those steps continuously until there is no data that exceeds the sheet width. Upon completion of those steps, the LCD display will give the tool conditions.

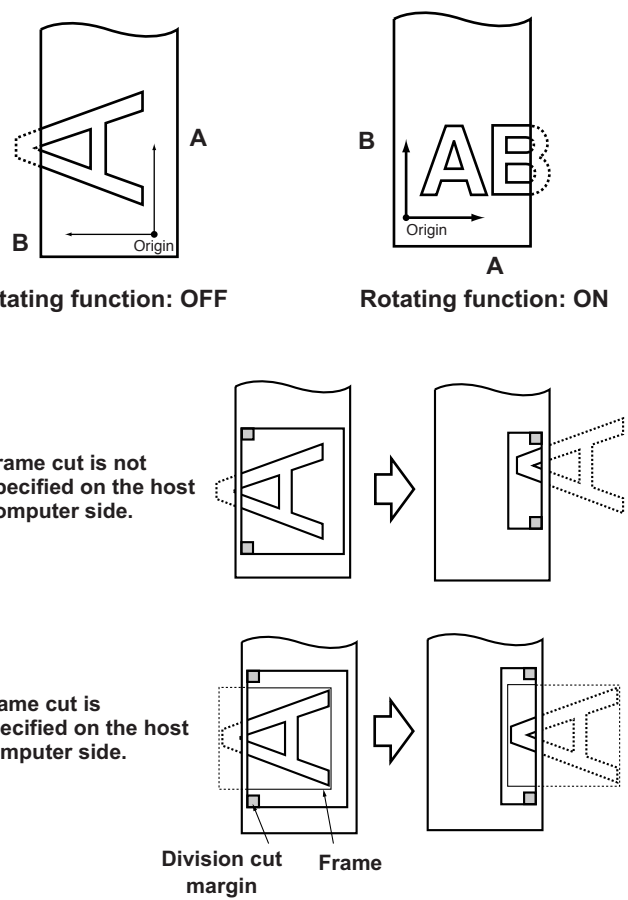

Before taking a phenomenon as a trouble

Take appropriate remedies referring to the phenomena described below.

The device cannot detect a sheet. [**** NO SHEET ****]

Cause 1 : A transparent sheet or a sheet of which wrong side is black is used.

Remedy 1 : Set the sheet sensor function to OFF.
--->P.19

The device performs cutting to produce broken lines.

Cause 1 : Screw in the tool holder has loosened.

Remedy 1 : Tighten the screw.--->P.10

Cause 2 : The blade of the cutter protrudes excessively.

Remedy 2 : Adjust the protruding amount of the blade adequately.--->P.30

Cause 3 : The blade is chipped or has worn out.

Remedy 3 : Replace the blade with a new one.
--->P.30

A communication error arises in prior to receiving data.

Cause 1 : The power to the device and that to the host computer have been turned on in wrong order.

Remedy 1 : Turn on the power to the host computer first. Then, turn on the power to the device.
--->P.7

The device does not operate even if the host computer sends data to the device.

Cause 1 : The plotter name specified on the host computer is wrong.

Remedy 1 : Check up the plotter name specified on the host computer.

Cause 2 : The interface cable is not securely connected to the device and/or the host computer.

Remedy 2 : Securely connect the interface cable.
--->P.7

An error arises on the device when the host computer sends data to the device.

Cause 1 : Communication conditions have not been properly established.

Remedy 1 : Check up the communication conditions.
--->P.8

Slippage of sheet arises in cutting.

Cause 1 : The pinch rollers and grid rollers fail to securely retain the sheet in position.

Remedy 1 : Check the position of the pinch rollers and grid roller and adjust them so that they securely retain the sheet in position.--->P.12,13

Cause 2 : The roller sheet is not wound with properly tensed and is slack. The sheet meanders or becomes aslant at the time of the sheet feed.

Remedy 2 : Remove a slack of the roll sheet and straighten the right and left end faces of the roll when loading the roll sheet on the device. Then, execute the sheet feed.--->P.12

Cause 3 : The sheet has bent to come off the mount to have air bubbles between them.

Remedy 3 : If the sheet is to be cut longer, take care not to allow the sheet to bend while it is fed or cut to avoid an extra load to the sheet.

Cause 4 : The sheet comes in contact with the floor surface. (The front end of the sheet is cut aslant.)

Remedy 4 : Decrease the cutting speed (SPEED) to reduce the load to the sheet when it contacts the floor surface.--->P.14,15

The device drags the tool during running.

Cause 1 : The sheet is warped.

Remedy 1 : Load the sheet on the device taking care not to warp it.

Cause 2 : The lifting/lowering of the tool is faulty.

Remedy 2 : Turn the power off and lift/low the tool holder by hand.

If the tool holder does not go up but remains in the lower position, call your distributor on the phone for maintenance.

Length in data and cut length are different.

Cause 1 : Sheet feed length will change depending on the sheet thickness.

Remedy 1 : Execute distance correction.

Troubles for which error messages are GIVEN ON THE LCD

If something is wrong with the device, a corresponding error message is given on the LCD.

Take an appropriate corrective measure according to the remedies given in the table below.

Message	Cause	Action
ERR02 MAIN RAM	Trouble has occurred in the control RAM.	Please call your dealer or our company's sales office for service.
ERR04 FRASH ROM	Trouble has occurred in the system ROM.	
ERR06 BUFFER	Trouble has occurred in the receiver buffer.	
ERR08 POWER	Trouble related to the motor has occurred.	
ERR10 COMMAND	Code other than command data has been received.	Check up the command data sent from the host computer.
ERR11 PARAMETER	A parameter outside the range of acceptable limits has been received.	Check up the parameter.
ERR12 DEVICE	The device received an improper device control command.	Check up the device control command.
ERR15 AUTO FEED	The device has failed to feed the sheet by the length specified with ZX command.	After the receipt of data sent from the host computer, replace the sheet with a longer-dimension one and execute the plural sheets cutting.
	During division cut, the device has failed to feed the sheet, according to the second data, by the length specified by the first data.	Load a longer sheet on the device and re-set the device in the remote mode.
ERR20 I/O	Communication conditions are wrong.	Establish the same communication conditions with those established on the host computer.
ERR27 BUFFERover	The interface is faulty.	Establish the same communication conditions with those established on the host computer or check up the interface cable.
ERR30 OPERATION	An inappropriate operation was performed on the control panel.	Perform the correct operation.
ERR31 NO DATA	The device has executed No. COPIES function to find that there is no data in the receiver buffer.	Refer to the explanation of the No. COPIES cutting function.
ERR32 DATAtooBIG	The amount of received data is too large for the device to perform the No. COPIES function.	Refer to the explanation of the No. COPIES cutting function.
ERR33 SHEET SIZE	The sheet is too short in terms of the feeding direction.	Use a longer sheet.
ERR34 DAT REMAIN	The device has executed an improper operation while it is put on hold.	Press the  key to cut the remaining data or clear it.
ERR40 MOTOR A	X motor has been applied with an over load.	Turn off the power to the device once. Then, turn it on again. If the same error message reappears on the LCD, contact your distributor.
ERR41 MOTOR B	Y motor has been applied with an over load.	
ERR42 A CURRENT	An overcurrent error in the motor in the lengthwise direction of the sheet has been detected.	
ERR43 B CURRENT	An overcurrent error in the motor in the widthwise direction of the sheet has been detected.	
ERR50 ORIGIN	The device has failed to detect the sheet size.	

Displays under the remote mode

The messages given below appear under the remote mode. They do not indicate errors but require an appropriate action.

Message	Cause	Action
CUT1 * REMOTE *	The device is in the remote mode.	A press on the <input type="button" value="REMOTE"/> key will cause the device to enter the local mode.
CUT1 * 128KB *	This indicates the amount of data received.	When starting cutting, the amount of data will decrease in increments of 1 KB.
** OFFSCALE **	The data on cutting exceeds the effective cutting area.	Use a larger sheet, decrease the amount of data or execute the divided cutting function.
** NO SHEET **	You have turned the sheet setting dial without loading a sheet on the device. The device stops after cutting to the end of sheet.	Place a sheet on the device and turn the sheet setting dial.
** VIEW **	The device has received the not-ready-mode signal (NR;) from the host computer to enter the local mode.	Execute required operations such as the sheet detection or the establishment of an origin. Then, press the <input type="button" value="REMOTE"/> key to make the device to enter the remote mode.
* 1/10 COPY *	The device is engaged in the plural sheets cutting. The number indicates the "1st sheet is being cut/Established number of sheets to be cut."	Upon completion of No. COPIES, the device will automatically enter the remote mode.
** END COPY **	The device terminates copying when one copy is finished since the data received contains the origin updating command (ZT;, !PG;).	No. COPIES function is disabled.
* DIVISION * 5s	The device has finished the cutting of data that exceeds the sheet width using the division cut and is now waiting for the receipt of next data.	If the device does not receive any data from the host computer within ten seconds, it will recognize the data has ended. Then, the device will perform the frame cut and margin cut and enter the local mode.
** DIVISION **	You have made the device to enter the remote mode during the division cut without establishing an origin or replacing the sheet.	Establish an origin or replace the sheet. Then, set the device in the remote mode.
* END DIVISION *	This message appears in the following cases. <ul style="list-style-type: none"> • In the case where the device has received data that contains the origin updating command (ZT;, !PG;) • In the case where the sheet width is 1 cm or less • In the case where the sample cutting data exceeds the sheet width 	Division cut is disabled.

Adjusting the Blade tip and the brade of cutter

Adjusting the blade tip of the cutter

Adjust the protruding amount of the cutter blade to the type of cutter and sheet of media to be used.

When you have adjusted the cutter blade, conduct test cutting to check the cutter for sharpness.



- Take care not to protrude the blade too much. If the cutter is used with its blade excessively protruded, the cutter can cut out the base paper to damage the main unit.

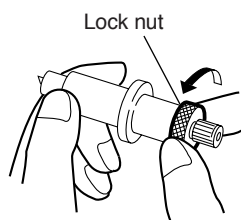

1. Loosen the locknut.

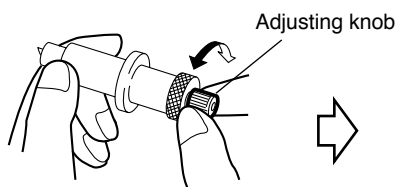

2. Turn the adjusting knob to adjust the protruding amount of the blade.

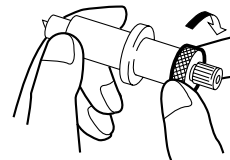

3. Tighten the locknut to secure the adjusting knob.

$$\text{Protruding amount of the cutter blade} = \frac{(\text{Film thickness} + \text{Base paper thickness})}{2}$$

Base paper thickness

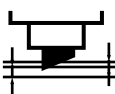

Film thickness



- The blade adjuster (model: OPT-S1005) will facilitate the adjustment of the protruding amount of the blade.

Replacing the cutter blade

Cutter blade is a consumable item. As you continue cutting, cutting quality will gradually degrade. By changing the speed value or pressure value of the cutter, improvement can be expected to some extent. If such changes do not improve the situation, replace the blade. Also, when the cutter blade is broken or rounded, replace the blade with a new one.

New blades (low-pressure blade set for PVC sheet: Model SPB-0030) are available from your distributor MIMAKI sales office.



- The cutter blade is sharp. Keep your fingers away from the blade.
- Never swing the cutter holder to avoid danger. Blade can jut out from the cutter holder, if swung.



1. Loosen the locknut.

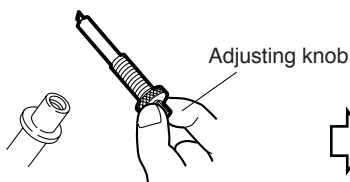

2. Turning the adjusting knob, draw out the cutter from the holder.

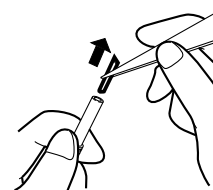

3. Replace the blade with a new one using tweezers or the like.

SPECIFICATIONS OF THE MAIN UNIT

Item		CG-60ST
Acceptable sheet width		50 to 711mm (Roll sheet : 50 to 670mm)
Effective cutting area (note 1)		586mm x 51 m (Normal) 606 mm x 51 m (Expand)
Maximum cutting speed		50 cm/s
Speed setting		1 to 10 cm/s (in 1 cm/s steps)
(cutting/plotting)		10 to 50 cm/s (in 5 cm/s steps)
Mechanical resolution		5 μm
Program steps		25 μm, 10 μm
Repeatability		±0.2 mm (excluding expansion/contraction due to film temperatures)
Maximum pressure		300 g
Pressure setting	Cutter	10 ~ 20 g (2 g step), 20 ~ 100 g (5 g step), 100 ~ 300 g (10 g step)
	Pen	10 ~ 20 g (2 g step), 20 ~ 100 g (5 g step), 100 ~ 150 g (10 g step)
Acceptable films		PVC sheets (0.15 mm thick or less), fluorescent sheets, reflective sheets (note 2)
Applicable tools		Cutters, water-ink ball-point pens and oil-ink ball-point pens, Ball-point pen on the market.*3
Commands		MGL-IIc2
Interface		RS-232C, 8-bit parallel
Receiver buffer		2 MB standard
Operating environment		5 to 35°C, 35 to 75 % (Rh) Non-condensing
Power capacity		AC100-240 V, 1A or less
Outside dimensions	Wide	875 mm
	Depth	385 mm
	Hight	315 mm
Weight		16 kg

•Notes Refer to the next page for the explanation of notes 1 to 3.

*1: Maximum feed length has a limitation depending on the software you use.

*2: When reflection sheet is used, use special blades (special blade for fluorescent sheet (SPB-0007), special blade for reflection sheet (SPB-0006)) which are available as optional items.

*3: As for the ball-point pen on the market, use the ones with 8mm~9mm diameter. Pen tip position may vary depending on the pen. Picture quality may also vary depending on the pen.

Option

Description	Code	Remarks	Suitable media	Offset [mm]	Pressure [g]	Speed [cm]
General vinyl use for low pressure	SPB-0030	Standard accessory. 3 PCs/set. Use to cut thin backing sheet. Less than 100g pressure. Cutting quality will be improved because of low pressure setting.	Vinyl sheet. Thickness from 0.05mm to 0.1mm	0.3	20-100	20-40
General vinyl use	SPB-0001	3 pcs/set Use to cut general vinyl sheet	Vinyl sheet. Thickness from 0.05 mm to 0.1 mm	0.3	100-150 50-100	20-40 20-40
Small characters	SPB-0003	3 pcs/set Use to cut sharp small characters. Not suitable to cut thick sheet.	Vinyl sheet. Thickness from 0.05 mm to 0.1 mm	0.15	50-100 40-80	20-40 20-40
For rubber sheet	SPB-0005	3 pcs/set. Use to cut rubber sheet less than 0.8mm	Rubber sheet less than 0.8 mm	0.75	200-300	5-20
For reflective sheet	SPB-0006	2 pcs/set. Long lifetime due to Titanium Coated. Also for Polyester film	Engineering grade & Polyester film less than 0.01 mm	0.75	250-400 200-300	5-15 5-20
For fluorescent sheet	SPB-0007	3 pcs/set	Fluorescent sheet	0.5	150-200	10-20
Cutter Holder	SPA-0001	1pc without blade				
Protrusion Adjustment	OPT-S1005	Optical type for SPA-0001				

FCC Statement (USA)

This equipment has been tested and found to comply with the limits for a Class A digital device, pursuant to Part 15 of the FCC Rules. These limits are designed to provide reasonable protection against harmful interference when the equipment is operated in a commercial environment. This equipment generates, uses and can radiate radio frequency energy and, if not installed and used in accordance with the instruction manual, may cause harmful interference to radio communications.

Operation of this equipment in a residential area is likely to cause harmful interference in which case the user will be required to correct the interference at his own expense.

The Mimaki logo consists of a stylized 'M' symbol followed by the word 'Mimaki' in a bold, sans-serif font.

Printed in Japan

D200417-1.50-23042004

© MIMAKI ENGINEERING CO., LTD. 2004