

FLAT BED CUTTING PLOTTER

CF2 Series

CF2-0912 / 1215 / 1218

T model

TD model

TF model

OPERATION MANUAL

MIMAKI ENGINEERING CO., LTD.

URL: <http://mimaki.com/>

This device is a first-class information processing device (information processing device that shall be commissioned in a commercial and industrial area) and conforms to the Voluntary Control Council Interference (VCCI) standard that has been developed for the purpose of prevention of radio disturbance in commercial or industrial areas. This device, therefore, can interfere with radios and televisions if put into service in a residential area and its adjacent areas. Correct handling procedure shall be followed according to this Operation manual.

In the case where MIMAKI-designated cable is not used for the connection of this device, limits provided by VCCI rules can be exceeded. To prevent this, use of MIMAKI-designated cable is essential for the connection of this device.

Interference to televisions and radios

The product covered by this Operation manual produces high frequency waves while it is in operation.

The product can interfere with radios and televisions if set up or commissioned under improper conditions. The product is not guaranteed against any damage to specific-purpose radio and televisions. The product's interference with your radio or television will be checked by turning off the power to the product.

If the interference is eliminated by turning the product off, the product is the cause of interference. In the event that the product is the cause of interference, try to eliminate it by taking one of the following corrective measures or taking some of them in combination.

- Change the direction of the antenna of your radio/television to find one that avoids interference.
- Install your radio/television at a place that is sufficiently spaced from the product.
- Connect the plug of your radio/television into a receptacle that does not share the power supply with the product.

DISCLAIMER OF WARRANTY

DISCLAIMER OF WARRANTY: THIS LIMITED WARRANTY OF MIMAKI SHALL BE THE SOLE AND EXCLUSIVE WARRANTY AND IS IN LIEU OF ALL OTHER WARRANTIES, EXPRESS OR IMPLIED, INCLUDING, BUT NOT LIMITED TO, ANY IMPLIED WARRANTY OF MERCHANTABILITY OR FITNESS, AND MIMAKI NEITHER ASSUMES NOR AUTHORIZES DEALER TO ASSUME FOR IT ANY OTHER OBLIGATION OR LIABILITY OR MAKE ANY OTHER WARRANTY OR MAKE ANY OTHER WARRANTY IN CONNECTION WITH ANY PRODUCT WITHOUT MIMAKI'S PRIOR WRITTEN CONSENT. IN NO EVENT SHALL MIMAKI BE LIABLE FOR SPECIAL, INCIDENTAL OR CONSEQUENTIAL DAMAGES OR FOR LOSS OF PROFITS OF DEALER OR CUSTOMERS OF ANY PRODUCT.

Reproduction of this manual in whole or in part is strictly prohibited.

FOREWARD

Congratulations on your purchase of a “CF2- Series” of flat bed cutting plotter.

This Operation Manual is intended for T-head model, TD-head model, and TF-head model, under the “CF2-Series”

Any function for which no head name is designated is common to all models of heads.

Please read and fully understand this manual before putting the machine into service. It is also necessary to keep this Operation Manual on hand.

NOTES

- Make arrangements to deliver this Operation manual to the person in charge of the operation of this device.
- This Operation manual has been carefully prepared for your easy understanding, however, please do not hesitate to contact a distributor or our office in your country if you have any questions.
- Description contained in this Operation manual are subject to change without notice.
- You can also download the latest manual from our website.

TABLE OF CONTENTS

Installation Site.....	ix
Restriction in use.....	x
FOR SAFE OPERATION.....	xi
For safe operation.....	xiii
Precautions in installation.....	xiv
HOW TO READ THIS INSTRUCTION MANUAL.....	xv
Structure of this Instruction Manual.....	xvi
FEATURES OF THE DEVICE.....	xvii

CHAPTER1 SET-UP

INSTALLATION SITE.....	1-2
CHECKING THE ACCESSORIES.....	1-4
EFFECTIVE CUTTING AREA.....	1-5
CONFIGURATION AND FUNCTION.....	1-6
Main unit.....	1-6
Head.....	1-8
Left-hand side face.....	1-9
Operation panel.....	1-10
CONNECTING THE CABLES.....	1-12
Connecting the signal wire cable for the blower.....	1-12
Connecting the interface cable.....	1-13
Connecting the power cable.....	1-13
TURNING THE POWER ON/OFF.....	1-15
Turning the power on.....	1-15
Turning the power off.....	1-15
EMERGENCY STOP.....	1-16
How to stop the device in an emergency.....	1-16
How to reset the emergency stop.....	1-16
LOCAL/REMOTE MODES.....	1-17
LOCAL mode and the indication on the LCD.....	1-17
REMOTE mode and the indications on the LCD.....	1-18
MATCHING THE FUNCTIONS OF THE DEVICE TO THE SPECIFICATIONS OF THE COMPUTER.....	1-19
Setting communication conditions [INTERFACE].....	1-19
Setting the commands to be used [MODE SET] > [COMMAND].....	1-20
Rendering the set values on the personal computer effective [MODE SET] > [COMMAND SW].....	1-21
Setting the response value with respect to the valid area [MODE SET] > [OH UNIT].....	1-22
Setting the command origin [MODE SET] > [ORIGIN].....	1-23
Setting the resolution (GDP) [MODE SET] > [GDP].....	1-24
SETTING FOR AUTOMATIC HEAD RETRACT [AUTO VIEW].....	1-25
AUTO-OFF FEATURE OF THE VACUUM.....	1-27
Auto-OFF/Panel-OFF[MODE SET]>[VACUUM].....	1-27

CHAPTER2 BASIC OPERATION

BASIC OPERATION ON THE LOCAL MENU	2-2
LOCAL menu.....	2-2
MODE SET menu.....	2-2
Basic operation on the LOCAL menu.....	2-3
BASIC OPERATION FLOW CHART	2-5
MOVING THE HEAD.....	2-6
Moving the head by “VIEW” function.....	2-6
Moving the head by the jog keys.....	2-7
FIXING A WORK.....	2-8
Fixing a work that is comparatively light in weight	2-8
Fixing heavy-weight packing etc.....	2-9
ADJUSTING THE BLADE.....	2-10
Tangential cutter	2-10
Swivel blade.....	2-11
ATTACHING THE TOOLS.....	2-12
Attaching the pen and the swivel blade.....	2-13
Attaching the tangential cutter.....	2-14
Installing the crease roller	2-15
ADJUSTING THE HEIGHT OF THE HEAD.....	2-16
SELECTING A TOOL [TOOL SELECT].....	2-18
SETTING CUTTING CONDITIONS [CONDITION].....	2-19
Setting items.....	2-19
Set values.....	2-21
Setting cutting conditions.....	2-23
CHECKING CUTTING CONDITIONS [TEST CUT].....	2-25
Checking the status of tools.....	2-27
Checking the status of tools.....	2-29
SETTING THE CUTTING AREA [CUT AREA].....	2-33
SETTING THE ORIGIN (ORIGIN FOR PLOTTING).....	2-36
INTERRUPTION OF PROCESSING (PLOTTING, CUTTING OR CREASING).....	2-37
How to interrupt/resume the process.....	2-37
Functions that can be specified after the interruption.....	2-37
.....	2-37
Interruption of processing [DATA CLEAR].....	2-37

CHAPTER3

WHEN ABNORMAL CONDITIONS ARE ENCOUNTERED

IF ANY OF THE BELOW-STATED PHENOMENA TAKES PLACE.....	3-2
Cutting depth is insufficient. [CONDITION] > [PRESS CORRECT]	3-2
The work remains uncut at the cutting start and end [CONDITION] >[START/END CORRECT]	3-2
[TOOL ADJUST] > [CIRCLE θ -CORRECT].....	3-2
Corrugated board is cut out at flutes though creasing is performed [CONDITION] > [PRESS (Y)]..	3-4
Square Mark not detected [TOOL Adjust] > [LIGHT POINTER].....	3-5

TOOLS ARE NOT ALIGNED TO EACH OTHER [TOOL ADJUST].....	3-6
Flowchart of checking and adjusting procedures.....	3-6
General explanation of the adjustment of tools.....	3-7
Adjustment of the cutter.....	3-7
Adjustment of the offset.....	3-10
Adjustment of the roller.....	3-11
How to adjust the tools.....	3-15
TROUBLESHOOTING.....	3-17
The device not at all actuates even when the power to the device is turned on.....	3-17
The device fails to actuate even when data is transmitted from CAD.....	3-17
Error arises when transmitting data.....	3-17
The tool drags on the sheet of paper.....	3-17
Dotted lines or blurred lines are plotted.....	3-18
TROUBLES FOR WHICH ERROR MESSAGES ARE GIVEN ON THE LCD.....	3-19
Errors that can be corrected by users.....	3-19
Errors that cannot be corrected by users.....	3-21

CHAPTER4 APPLICATION FUNCTIONS

ASSIGNMENT OF PEN NUMBERS [MODE SET] > [PEN ASIGN].....	4-2
RE-CUT OF THE SAME DATA [COPY].....	4-4
SETTING THE NUMBER CUT FUNCTION [MODE SET] > [MULTI-PASS].....	4-6
SETTING THE ONE-STROKE CUTTING [MODE SET] > [ONE STROKE].....	4-8
SETTING THE DIRECTION OF ROTATION FOR THE COORDINATE AXIS [MODE SET] > [ROTATE].....	4-9
SETTING THE CUTTER STROKE [MODE SET] > [Z STROKE].....	4-10
SETTING THE UNIT TO BE USED FOR INDICATION [MODE SET] > [UNIT].....	4-11
SETTING THE DUMMY CUT OPERATION OF THE SWIEVEL BLADE [MODE SET] > [DUMMY CUT].....	4-12
ALIGNMENT OF MECHANICAL AXES TO RULED LINES PRINTED [AXIS ALIGN].....	4-13
EXPAND THE CUTTING AREA [EXPANDS].....	4-15

CHAPTER5 REGISTER MARK DETECT FUNCTION

SETTING OF REGISTER MARK DETECT.....	5-2
How to display the register mark setting on LCD.....	5-2
PRECAUTIONS IN PREPARING DATA WITH REGISTER MARK.....	5-3
Size of the square mark.....	5-3
Size of the register mark.....	5-4
The area where register marks and designs can be arranged.....	5-5
No-plotting area around the register marks.....	5-6
The size of, and the distance between, register marks.....	5-9
Color of Register mark.....	5-10
Register mark Blurred.....	5-10
SETTING OF REGISTER MARK DETECT OPERATION.....	5-11
Precautions on register mark detection.....	5-11

How to display the register mark setting on LCD	5-11
Settings for detection of marks.....	5-12
Settings for detect.....	5-14
How to detect Register mark.....	5-15
CONTINUOUS CUT WITH REGISTER MARK.....	5-17
INITIALIZE THE REGISTER MARK SCALE ADJUSTMENT [SC.CLR].....	5-18

CHAPTER6 SELF-TEST

CONFIRMATION OF CUTTING QUALITY ONLY BY THE SINGLE UNIT OF THE DEVICE [SELF TEST].....	6-2
Cutting quality * / Sample * * * / Circle cutting R = * *	6-3
DUMP TEST [SELF TEST]	6-5
Executing the data dump.....	6-5
Execution of the parameter dump.....	6-7

CHAPTER7 APPENDIX

REPLACING THE BLADE PROTRUSION	7-2
Tangential cutter blade	7-2
Swivel cutter blade.....	7-3
B. LOCAL MENU STRUCTURE.....	7-5
T-head model	7-5
TD/TF-head model	7-7
C. OUTPUT SAMPLES.....	7-9
Cutting quality 1	7-9
Cutting quality 2	7-9
ASCII dump list.....	7-9
Sample (coated)	7-10
Sample (E corrugated).....	7-10
Sample (B corrugated).....	7-11
Circle cutting R = 3/5/10/20/50/100.....	7-11
Parameter dump list.....	7-12
D. SPECIFICATIONS	7-13
Basic specifications	7-13
Specifications for interface specifications.....	7-14
E. MAINTENANCE	7-15
Cutting panel surface.....	7-15
Cover.....	7-15
Filter unit.....	7-15
F. OPTIONAL ACCESSORIES.....	7-17
Swivel cutter components	7-17
Tangential cutter components.....	7-17
Creasing roller components.....	7-18
Pen components	7-18
Optional products	7-18

Installation Site

The structure of model name is as follows.

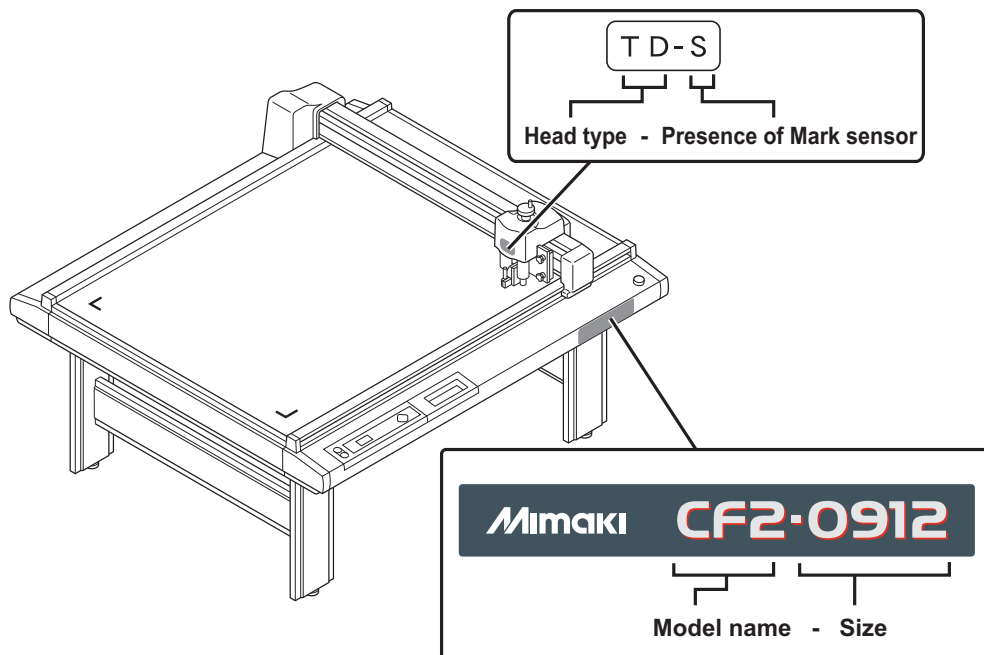

Model Name: CF2

Size

0912	1200 × 900 mm
1215	1500 × 1200 mm
1218	1800 × 1200 mm

Head type

T	Tangentail cutter
TD	Tangentail cutter unit Creasing unit
TF	Tangentail cutter unit High pressure tangentail cutter

Mark sensor

N	No mark sensor
S	Mark sensor equipped

Restriction in use

Restriction in use

This device are limited to the user who understands this dangerousness completely.

Restriction for user

This device shall get proper training. Limit to the user those who got proper training to operate.

Restriction area

Set up the restriction area for This device within the range indicated below.

Do not let the person other than the user who got proper training close to the machine.

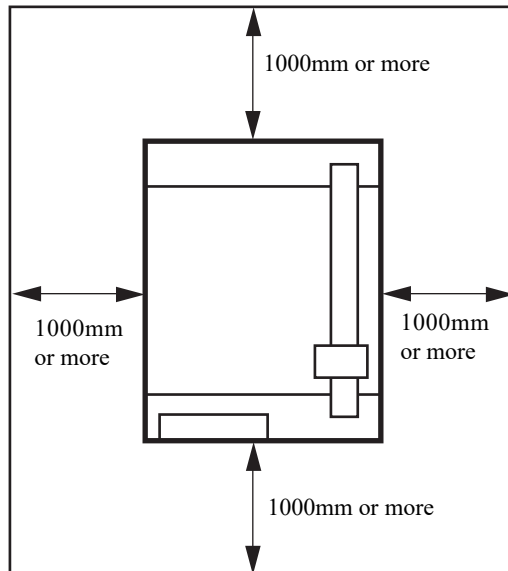



FOR SAFE OPERATION

Prior to using this device, be sure to read this Operation manual and become fully familiar with its operation method and usage cautions.

Pictorial signs

Pictorial signs are used in this Operation manual for safe operation of and in prevention of damages to the device. Pictorial signs and their meanings are given below. Read and fully understand the following before reading the text.

	<ul style="list-style-type: none">• Indicates the case where it is assumed that misuse of the machine, ignoring this sign, can expose the operator to danger of injury or death.
---	--

	<ul style="list-style-type: none">• Indicates the case where it is assumed that misuse of the machine, ignoring this sign, can cause danger only to property.
---	---

Example of pictorial signs



The symbol “” indicates the case where some phenomenon that requires a CAUTION sign (including “DANGER” and “WARNING” signs) exists. A concrete precaution (precaution against an electric shock in the case of the sketch given on the left) is shown in the illustration.



The symbol “” indicates a prohibited behavior. A concrete illustration of prohibition (disassembly is prohibited on the sketch given on the left) is shown in or next to the illustration.















The symbol “” indicates a thing that is forced to be done and instruction that is forced to be followed. A concrete illustration of instruction (the removal of a plug from the receptacle is instructed in the sketch given on the left) is drawn in the illustration.









The symbol “” indicates helpful information that will facilitate the use of the device.









 **WARNING**

Do not disassemble or remodel the device	Handling of the cable
 <ul style="list-style-type: none"> Never disassemble or remodel the main unit of the plotter and the blower unit. Disassembling/remodeling any of them will result in electric shocks or breakdown of the device. 	 <ul style="list-style-type: none"> Take care not to damage, break or work on the power cable or communication cable. If a heavy matter is placed on the power cable, heated or drawn, the power cable can break to cause fire or electric shocks.
Do not use the device in damp places	Handling of tools
 <ul style="list-style-type: none"> Avoid damp environments when putting the device into service. Do not splash water onto the device. High-humidity or water will give rise to fire, electric shocks or breakdown of the device. 	 <ul style="list-style-type: none"> Store cutter holders or blades in a place that is out of the reach of children. Never place cutter holders or blades in the tray on the operation panel.
Abnormal event occurs	Preventive measure against dust
  <ul style="list-style-type: none"> If the device is used under an abnormal condition where the device produces smoke or unpleasant smell, fire or electric shocks can result. Be sure to turn off the power switch immediately and detach the plug from the receptacle. Check first to be sure that the device no longer produces smoke, and contact a distributor in your district or MIMAKI office for repair. Never repair your device by yourself since it is very dangerous for you to do so. 	  <ul style="list-style-type: none"> When handling any dust-producing substance that will jeopardize the health of personnel, wear a mask or the like to prevent dust.
Power supply and voltage	Leave maintenance to a serviceman
  <ul style="list-style-type: none"> Be sure to use the device with the power supply specifications indicated. Be sure to connect the plug of the power cable to a grounded receptacle. If not, fire or electric shocks can result. 	 <ul style="list-style-type: none"> Leave maintenance works to a serviceman whenever the device has broken. Never conduct maintenance works by yourself since the works are always accompanied by possible risks of electric shocks, etc.

For safe operation

 CAUTION	
Use the following electrical specifications	Do not dress baggy suits and accessories
 <ul style="list-style-type: none"> Be sure to connect the power cable to a power outlet with the following electrical specifications. Be sure to perform tap change depending on the voltage. Main unit: 100 to 240 VAC±10% 50/60 Hz 300W or higher 	 <ul style="list-style-type: none"> Do not work with dressing baggy suits and any accessories, and also tie any long hairs.
Do not restart the power until 30 seconds after turn off	Do not move your face in front of cut panel
 <ul style="list-style-type: none"> If the device is restarted, do not turn on the power until 30 seconds after turning off. The device may be caused faulty function. 	 <ul style="list-style-type: none"> Do not move your face and hands in front of the cut panel while the unit is working. The device can wind and touch your hairs or hands.
Do not put any matters on the cable	The device is moved by our service engineer only
 <ul style="list-style-type: none"> Do not bend the power cable and the communication cable, and do not placed any matters. These cables may be broken and heated, the power cable can cause fire or electric shocks. 	 <ul style="list-style-type: none"> The device is too sensitive equipment, so in case if you require movement of the unit, please contact to our service engineer.

Precautions in installation

 CAUTION	
A place exposed to direct sunlight	A place that vibrates
 <ul style="list-style-type: none"> Do not install the device at a place where the temperature of the cut panel surface exceeds 60°C. The cut panel can deform or break down. 	 <ul style="list-style-type: none"> The device will fail to give correct results if installed in a place that vibrates.
A place in which temperature and humidity vary by a great margin	A place filled with dirt, dust or tobacco smoke
 <ul style="list-style-type: none"> Use the device under the following environment. Operating environment: 5 to 40°C 35 to 75% (Rh) 	 <ul style="list-style-type: none"> The plotter is a precision machine. Do not use it in a place that is filled with dirt and dust.
A place exposed to direct air blow from air conditioner., etc	Near flammable materials
 <ul style="list-style-type: none"> Cutting quality could be adversely affected. 	 <ul style="list-style-type: none"> The plotter is a precision machine. Do not use it in a place that is filled with dirt and dust.
A plate that is not horizontal	
 <ul style="list-style-type: none"> If the plotter is not leveled, the plotter will fail to give correct results. Also the tilted plotter can break. 	

HOW TO READ THIS INSTRUCTION MANUAL

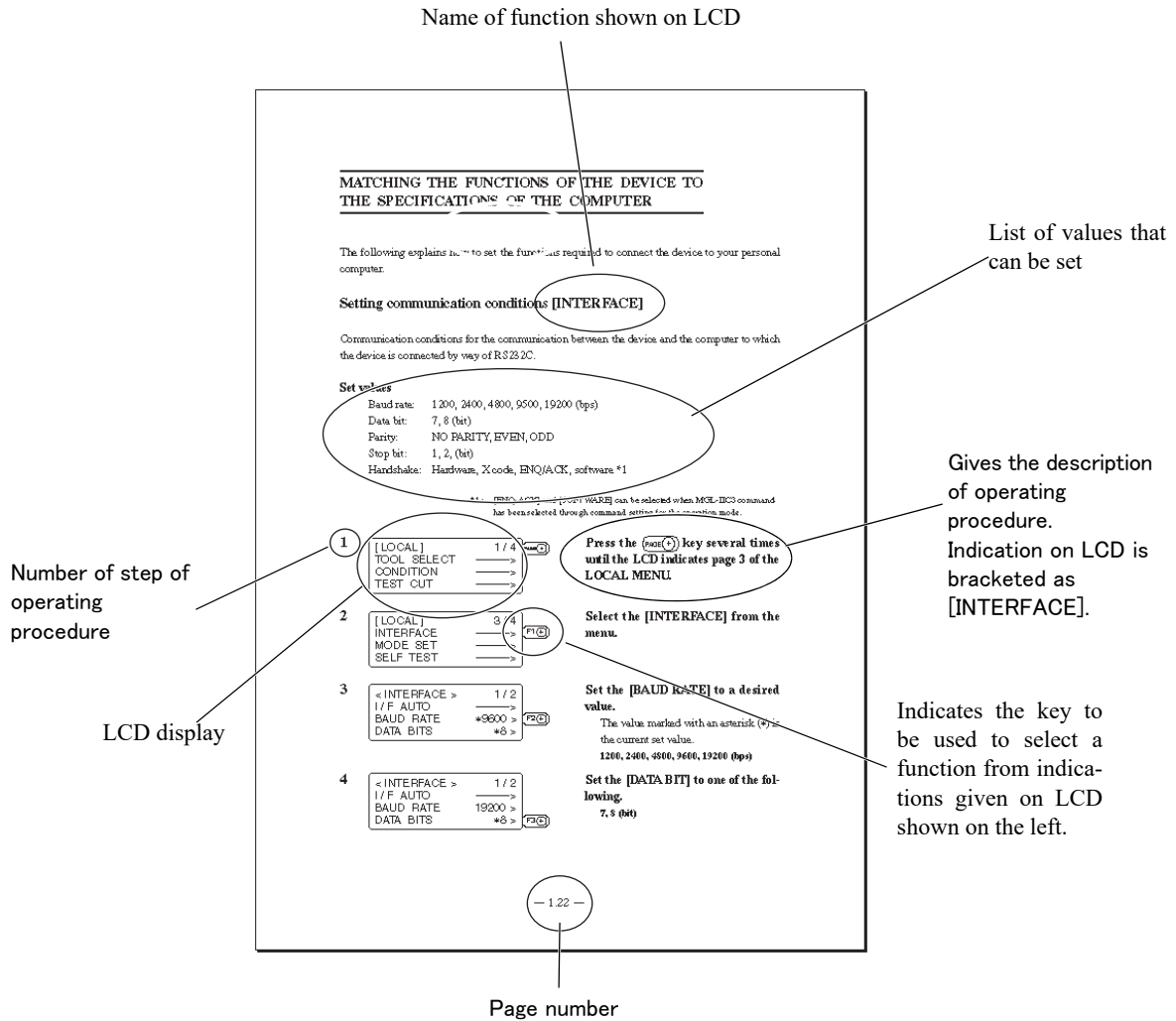

Structure of this Instruction Manual

Chapter 1 Set-up

This chapter describes the procedures to be taken after the unpacking to specify functions that are required for the connection of this device to your computer.

Chapter 2 Basic operation

This chapter describes normal operation of the device such as the replacing/attaching of tools or works.

Chapter 3 When abnormal conditions are encountered

This chapter describes how to correct troubles after the occurrence of an abnormal condition on the device.

Chapter 4 Application functions

This chapter describes helpful functions that facilitate operation.

Chapter 5 Square mark detect function

This chapter describes square mark function

Chapter 6 Self-test

This chapter describes “self-test” that is performed to check whether or not the device unit has failed.

Appendix

This appendix describes the replacement of blades, menu structure and output samples and introduces separately-available parts.

FEATURES OF THE DEVICE

The device is capable of cutting heavy-weight materials and solid materials.

The device performs high-pressure cutting to permit the maximum cutting weight of 1.5 kg (5.0 kg for TD- and TF-heads). It also permits the setting of heavy-weight materials as heavy as 25 mm.

With its tangential control that demonstrates its capability particularly when cutting hard materials, the device is able to cut, as desired, many different kinds of materials such as high-intensity reflective sheet, sand blast rubber, industrial sheet rubber and corrugated board.

Heads corresponding to materials are prepared

User-replaceable heads are lined up. Selection can be made according to applications.

T-head: Tangential cutter + Pen/swivel cutter

TD-head: Tangential cutter + Creasing roller + Pen/swivel cutter

TF-head: Tangential cutter + High-pressure tangential cutter + Pen/swivel cutter

■Applicable materials

T-head	TD-head	TF-head
<ul style="list-style-type: none"> • Vinyl chloride sheet for signboard • Reflecting sheet • Vinyl chloride for interior/exterior decoration • Sand-blast rubber • Industrial sheet rubber (Thickness: 3.0 mm or less) • Wood rack • Coated board No. 10 • Synthetic leather 	<ul style="list-style-type: none"> • Materials applicable to T-head + • Corrugated fiberboard (E to A corrugation) • Plastic corrugated fiberboard, etc. 	<ul style="list-style-type: none"> • Materials that are applicable to T-head + • Industrial sheet rubber Nitril rubber (Thickness : 0.5 to 7.0 mm) • Silicon rubber (Thickness : 0.5 to 7.0 mm) • Fluoro rubber (Thickness : 0.5 to 7.0 mm) • Urethane rubber (Thickness : 0.5 to 3.0 mm) • Cloth-inserted rubber sheet (Thickness : 0.5 to 5.0 mm) • Joint sheet (Thickness : 0.4 to 3.0 mm) • Teflon (Thickness : 1.0 to 3.0 mm) • Soft vinyl chloride (Thickness : 0.5 to 7.0 mm) • Rigid vinyl chloride (Thickness : 0.5 to 3.0 mm), etc.

Upgraded reliability and consistent cutting quality

With its four-axis (X, Y, Z, θ) software servo control, the device promises upgraded reliability. With its high-rigid drive mechanism, the device produces high- precision beautiful cutting results while preventing overshoot and warp. Furthermore, eccentricity of the cutter holder can be adjusted through software by the eccentricity correcting function, achieving cutting results with upgraded accuracy.

The device incorporates a mechanism that securely supports works.

Air-suction work clamping system has been introduced to the table unit on which works are secured.

This allows works to be clamped without fail and to be easily placed/removed on/from the device.

Furthermore, the table is equipped with a plate surface that protects the cutter blade at the time of performing die-cut. In addition, a roll hanger is optionally available. With these options, the device allows rolled materials to be set.

High-quality performance with its most-advanced functions,

Start/end point correction

In the case of processing heavy-weight works, works can be easily cut out by correcting the start and end positions for cutting.

Pressure correction

In the case of cutting heavy-weight works, works can be fully cut with no portion remained uncut by correcting the pressure employed to lower the tool.

Circle θ correction

When cutting out a circle, the start and points of cutting sometimes fail to align in accordance with thickness and hardness of the work used. However, an almost regular circle can be cut out by correcting the amount of such a departure.

Cutting conditions for two or more tools can be entered.

Cutting conditions such as pressure, speed, start/end point correction, circle θ correction and offset can be entered separately for two or more tools.

Square mark detect function

Square mark detect function with a high-performance color photo sensor is provided.

Detection of square mark is available on any colored media.

This function is supported with S (sensor equipped) model.

- **Continuous cut**
If the same data is positioned equally spaced, with detecting a square mark, automatically cut the specified number of copies.
- **Divide cut**
In the case data is larger than maximum cut area, cut as divided.

Easy to set the media

With a removable media guide, easy to set the media. Moreover with a mark chip, reverse cut is supported.

CHAPTER 1

SET-UP

This chapter describes the procedure to be taken after the unpacking to specify functions that are required for the connection of this device to your computer.

Table of Contents

<i>INSTALLATION SITE</i>	1-2
<i>CHECKING THE ACCESSORIES</i>	1-4
<i>EFFECTIVE CUTTING AREA</i>	1-5
<i>CONFIGURATION AND FUNCTION</i>	1-6
<i>CONNECTING THE CABLES</i>	1-12
<i>TURNING THE POWER ON/OFF</i>	1-15
<i>EMERGENCY STOP</i>	1-16
<i>LOCAL/REMOTE MODES</i>	1-17
<i>MATCHING THE FUNCTIONS OF THE DEVICE TO THE SPECIFICATIONS OF THE COMPUTER</i> <i>1-19</i>	
<i>SETTING FOR AUTOMATIC HEAD RETRACT [AUTO VIEW]</i>	1-25
<i>AUTO-OFF FEATURE OF THE VACUUM</i>	1-27

INSTALLATION SITE

Install the device at a place where the below-stated installation area is provided.



- Place nothing within an installation area. If a thing is placed, the risk of tripping over will be caused.

Installation area (CF2-0912)

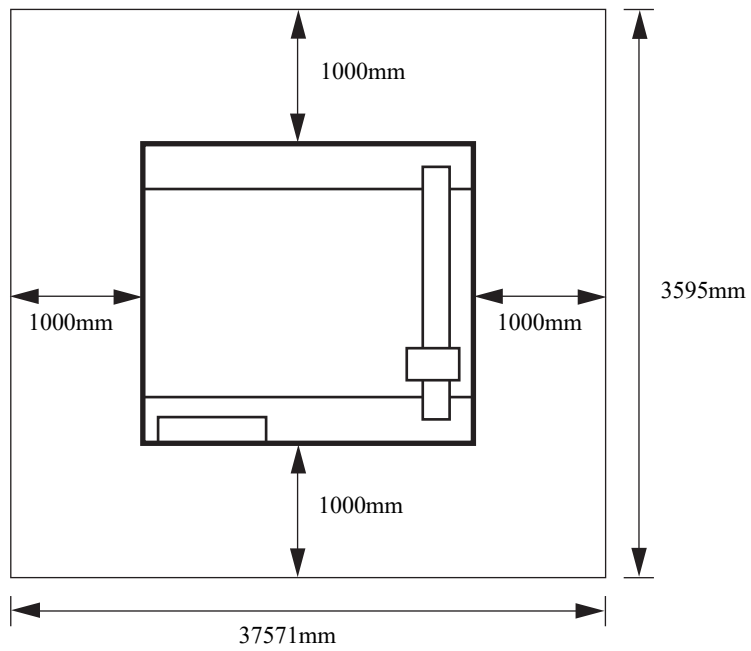

Installation area (CF2-1215)

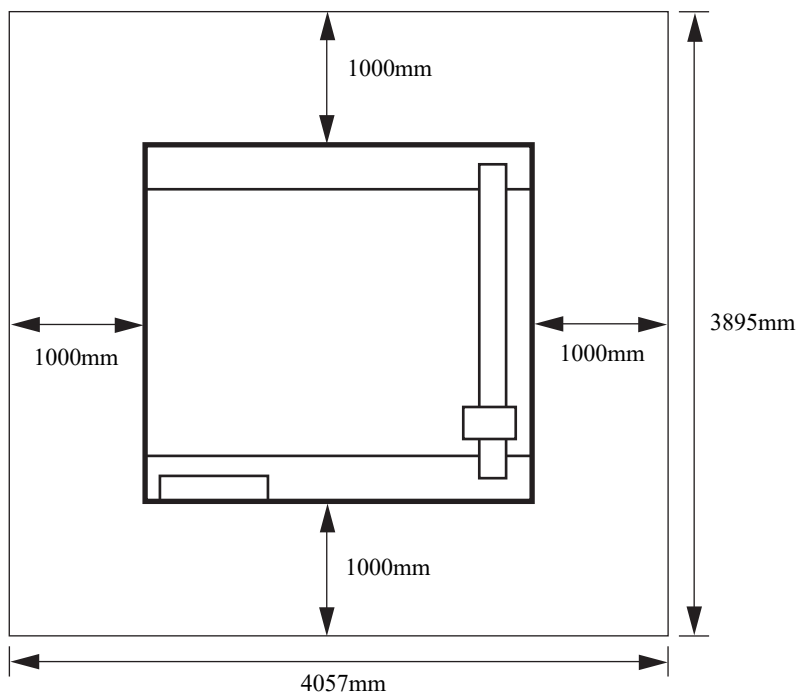

Installation area (CF2-1218)

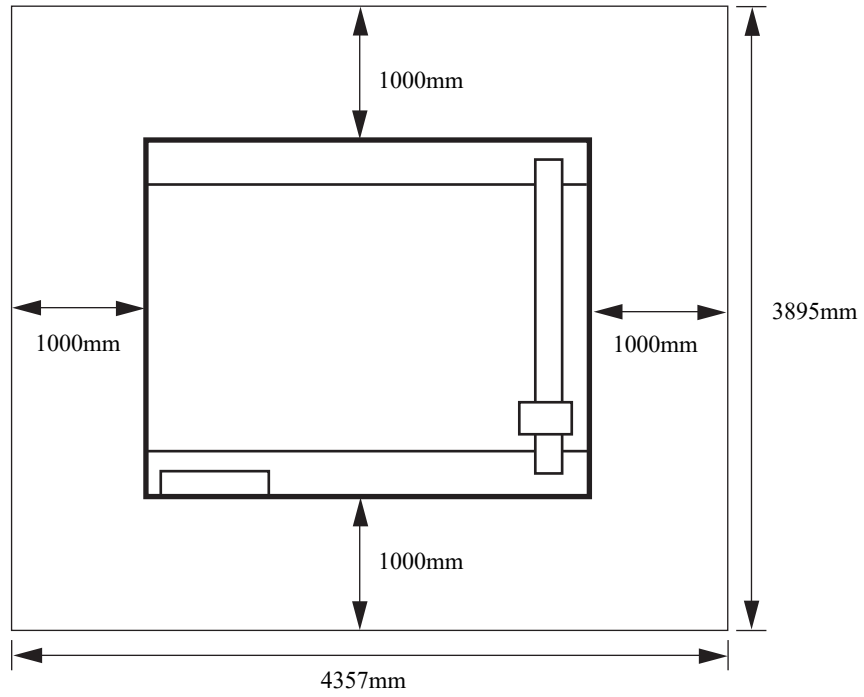

CHECKING THE ACCESSORIES

Accessories differs with the models of heads and applications. Check the accessories referring to the accompanying “Accessory list.”

If you find any missing accessory or damaged one, contact your local dealer or MIMAKI office.

EFFECTIVE CUTTING AREA

The maximum effective cutting areas by the models of devices are given below.
 The maximum cutting area does not change by the models of heads (T-head, TD-head, and TFhead)

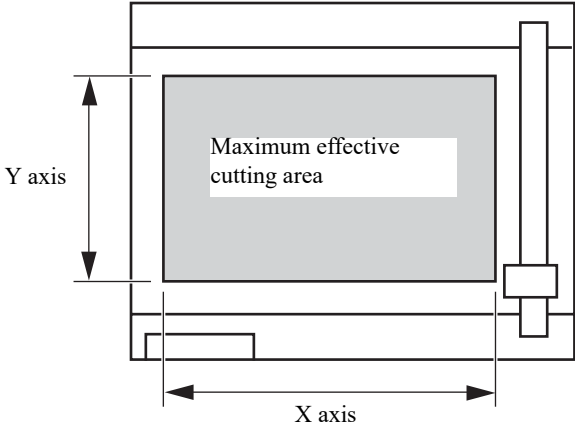

	Model name	X axis (mm)	Y axis (mm)
Mark sensor equipped model	CF2-0912	1170	900
	CF2-1215	1470	1200
	CF2-1218	1770	1200
Mark sensor not equipped model	CF2-0912	1200	900
	CF2-1215	1500	1200
	CF2-1218	1800	1200

CONFIGURATION AND FUNCTION

Main unit

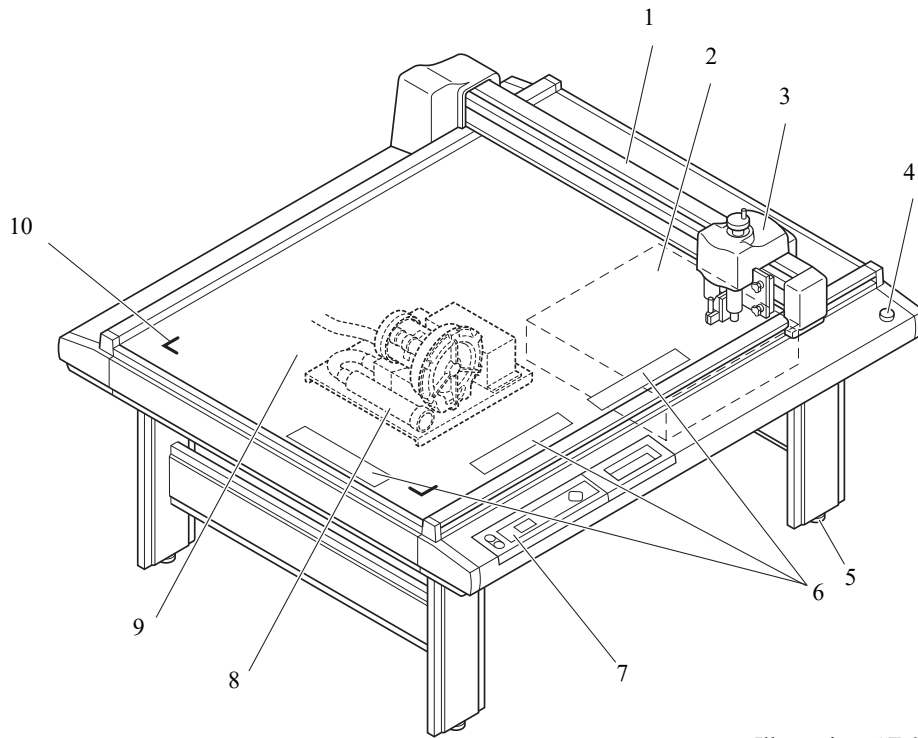
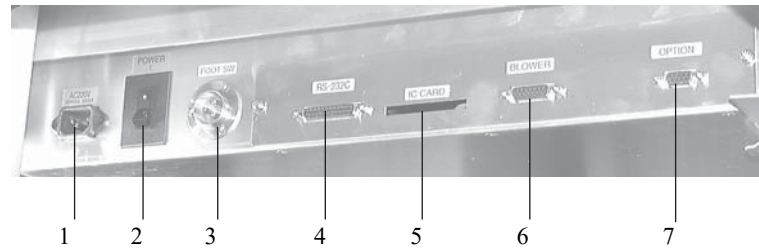

Illustration: CF-0912 (TD, TF, T)

	Name	Function
1	Y bar	Moves the head in Y direction
2	Electrical box	PCBs or the like are built in this box.
3	Head	Tools are attached to the head. Tools that can be set to the head differs with the models of heads.
4	EMERGENCY switch	To be pressed at the time of emergency. Pressing this switch forcefully turns the power off to make the device to stop performance.
5	Adjuster foot	Adjusts the height of foot and keeps the cut panel surface leveled.
6	Work Guide	Align the work to set straight.
7	Operation panel	Data required for the operation of the device are specified on this panel.
8	Blower unit (Option)	This allows a work to be pneumatically picked on the cut panel.
9	Cut panel	A board to which a work is attached. Air-suction small holes are arranged regularly on it.
10	Origin sticker	Indicates the maximum effective cutting area.

Right-hand side face of the electrical box



	Name	Function
1	Power connector	To be connected to the power cable of the plotter.
2	Main power switch	Used to turn on/off the main power of this device. Normally set it to the on state. Set it to the off state when conducting maintenance works.
3	Foot switch connector	Foot switch for vacuum is connected to this connector. (Optional)
4	RS-232C interface	To be connected to a personal computer using an interface cable.
5	IC card slot	To be used when conducting maintenance works.
6	Signal wire connector for blower	To be connected to the blower unit (option) using a signal wire.
7	Optional connector	Connector to support particular purpose use.

Right-hand side face of the blower unit (Option)

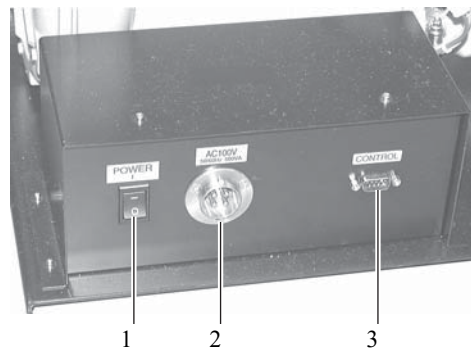

	Name	Function
1	Power switch	Used to turn on/off the power to the blower unit. Normally, it is set to the on position. Turn it off when conducting maintenance works.
2	Signal wire connector	To be connected, using a signal wire, to the signal wire connector for the blower on the electrical box.
3	Power connector	The power cable for the blower is connected to this connector.

Head

Front face



	Name	Function
1	Head securing screw	Used to fix the head on the Y bar. Loosen it when adjusting the height of the head or removing the head.
2	Head C	A marking roller or a high-pressure cutter is attached to the head C. (Only to TD- / TF-head)
3	Mark sensor	Used to detect the square mark. (Mark sensor equipped model only)
4	Light pointer	Light up in red when matching the position for square mark detection. (Mark sensor equipped model only)
5	Head A	A pen or swivel cutter is attached to the head C.
6	Head B	A low-pressure cutter is attached to the head B. (Heads excluding the P-head)









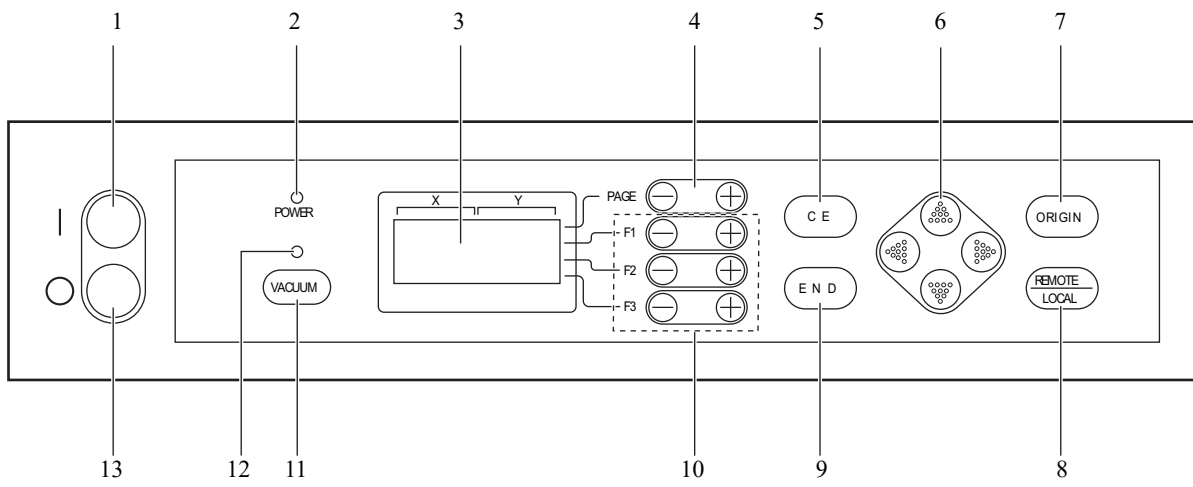

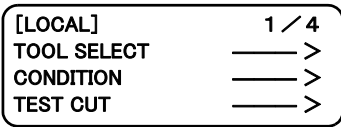
Left-hand side face

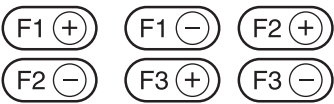

	Name	Function
1	Height adjusting knob	Used to adjust the height of the head.
2	Height adjusting bar	Used to adjust the height of the head in accordance with the thickness of a work to be used.

Operation panel



	Name	Representation	Function
1	POWER ON switch		Used to turn ON the power to the device.
2	POWER lamp		Lights up (in green) when the power to the device is turned on.
3	LCD		LCD indicates states of the device and specified menus on its 16-column and 4-line cells. In the case where an indication on LCD is referred to in the text, it is shown with bracketed as [Tool select].
4	PAGE key		Used to advance or return the page on the LCD.
5	CE key		Used to cancel the performance (data clear, copy, etc.) or return to the previous hierarchy without entering an input value.
6	JOG key		Used to scroll the head in the direction of the arrow while local menus (👉 P. 2-2 are displayed.
7	ORIGIN key		Used to set a plotting origin (ORIGIN) at the top of the cutting area of the device.
8	REMOTE/LOCAL key		Used to change over the operation mode of the device between the remote and the local modes.
9	END key		Used to enter an input value. When local menu (1/4 to 4/4 page) is displayed, move a head to the allow direction.
10	FUNCTION key		Used to select a function from the local menu and input a set value.
11	VACUUM key		Used to turn on/off the blower for pneumatically picking a work.
12	VACUUM lamp		Lights up (in green) when pressing the  key to actuate the blower.
13	POWER switch		Used to turn off the power to the device.

CONNECTING THE CABLES



- Be sure to turn off the the power to the device in prior when connecting the signal wire cable for the blower, interface cable and the power cable. If not, there will be a fear of the arising of electric shock hazards and damage to the device.

Connecting the signal wire cable for the blower



- Do not block the exhaust port of the blower unit (option). Blocking it can drop the suction force or give rise to a failure.

The signal wire cable for the blower connect the electrical box located below the cutting panel surface to the blower unit.

1. **Insert one end of the signal wire cable for the blower into the connector of the electrical box.**

Fix the connector with screws.

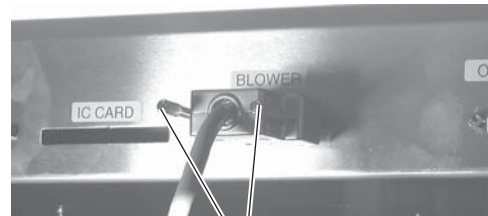

Screws

2. **Insert the other end of the signal wire cable for the blower into the connector on the blower unit (option).**

Fix the connector with screws.



Screws

Connecting the interface cable

The device is equipped as standard with an interface conforming to RS-232C.
Use a MIMAKI-recommended interface cable or a cable that matches your computer.

1. Turn off the power to the plotter and that to the personal computer.
2. Insert one end of the interface cable into the connector on the electrical box.

Fix the connector with screws.

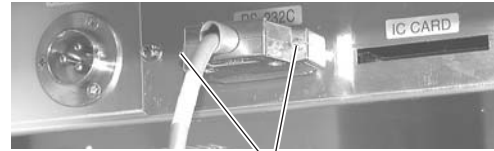

Screws

3. Insert the other end of the interface cable into the connector of the computer.

Fix the connector with screws.

Connecting the power cable

Two power cables are needed, one for the main unit and the other for the blower unit (option).
Insert the respective power cables into the receptacles of the following specifications.

	Power cable for the main unit	Power cable for the blower
Voltage	100 VAC $\pm 10\%$ / 220 VAC $\pm 10\%$	Depend on the types of option
Frequency	50/60 HZ $\pm 1\%$	
Capacity	500W or more (10A or more)	



- Be sure to insert the power cable into an appropriately-grounded receptacle.
If not, there is a fear of the arising of electric shock hazards and damage to the device.



- Many types of blowers are available as an option.
Cable specification differs depend on the blower type. Be sure to follow the "Blower installation" manual when connecting.

1. Press the POWER OFF switch .



-
2. Insert the power cable for the plotter into the AC inlet of the electrical box.

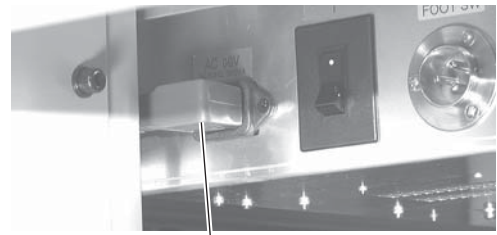

Power cable for the main unit

3. Insert the other end of the power cable into the 3P receptacle.



- In the case where a 2-pole receptacle is used, additionally use the installation adapter supplied with the unit as an accessory. Properly ground the earth cable (green one), then insert the power cable to the receptacle.
- If the earth cable cannot be properly grounded, contact electrical work shop in your district.

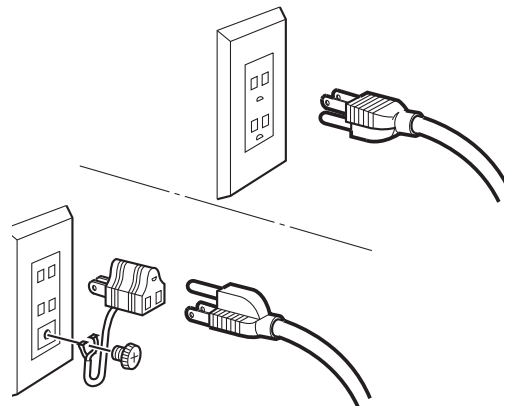

TURNING THE POWER ON/OFF

The device is provided with separate switches for turning the power on and off. Turn on/off the power to the device following the procedure described below.



- Do not place any thing other than a work on the cutting panel when turning the power on. Turning the power on causes the head to travel to the retracted point located at the lower right of the cutting panel. If a thing is present on the cutting panel, the head may come in contact with the thing, giving rise to a failure.
- If the device is restarted, do not turn on the power until 30 seconds after turning off. The device may be caused faulty function.

Turning the power on

1. **Check to be sure that nothing is placed on the cutting panel.**

If there is a thing on the cutting panel, remove it from the panel.

2. **Press the POWER ON switch** (ⓘ).

The POWER lamp lights up (in green).

The head travels to the retracted point (at the lower right) on the cutting panel.

Then, the first page of the local menu will appear on the LCD.



Turning the power off

To turn the power off, check first whether or not there is data received and there remains data that has not yet been output in the device.

To check for the remaining data, press the  key to cause the device to enter the REMOTE mode. The amount of data received is displayed on the LCD, and the device starts cutting (plotting) according to the data displayed.

To clear the remaining data received, press the  key to cause the device to enter the LOCAL mode, then execute the “data clear” function. (ⓘ P. 2-37)

1. **Turn off the power to the personal computer that is connected to the device.**

2. **Press the POWER OFF switch** (⓪).

The POWER lamp goes out to turn the power off.



POWER DOWN WAIT

EMERGENCY STOP

In an emergency, the device can be stopped at once.

How to stop the device in an emergency

1. **Press the EMERGENCY button.**

This causes the device to stop its operation and turns the power off.



How to reset the emergency stop

1. **Turn the EMERGENCY button clockwise for unlocking.**



2. **Press the POWER ON switch (ⓘ).**

The device will start up.



- Do not restart the power until 30 seconds after turn off.
If the device is restarted, do not turn on the power until 30 seconds after turning off. The device may be caused faulty function.

LOCAL/REMOTE MODES

The operation mode is changed over alternately between the LOCAL mode and the REMOTE mode every time the  key is pressed.

LOCAL mode and the indication on the LCD

Under LOCAL mode, the head travels, functions of the device are set, and data from the personal computer are received.

All keys on the operation panel are rendered operative under the LOCAL mode.

Under the LOCAL mode, the following three different kinds of indications are given on the LCD.

LOCAL menu: Function name selecting screen

This screen appears when the power to the device is turned on. The main menu consists of four pages.

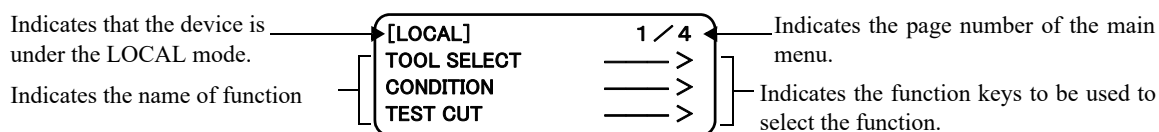

Sub menu 1: Set value inputting screen

This screen appears after a function has been selected on the main menu using the corresponding function key. A set value can be input on this screen using function keys.

The asterisk (*) mark given on the left of the set value indicates that the value is currently valid.

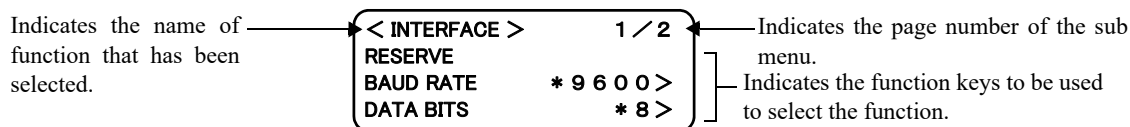

Sub menu 2: Function executing screen

A function is executed on this screen. Functions that can be executed include “test cut,” “data clear” and “automatic judgment of communication conditions.”

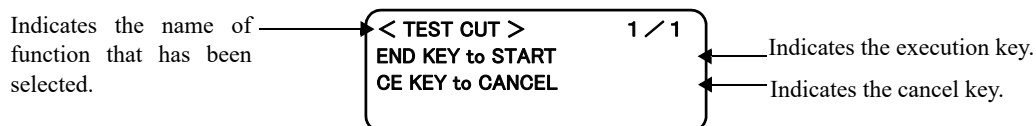

REMOTE mode and the indications on the LCD

Under the REMOTE mode, cutting or plotting can be carried out in accordance with data received.

The LCD indicates cutting (plotting) conditions and the capacity of data received.

Capacity of data decreases as you proceed with cutting (plotting). The POWER ON (ⓘ) key, POWER OFF (Ⓞ) key, the (VACUUM) key and the (REMOTE LOCAL) key are operative.

Under the REMOTE mode, the following three different indications are shown on the LCD.

When the tangential cutter or marking roller is selected:

This REMOTE screen appears when [HEAD: B] and [TOOL: CUTTER1 OR CUTTER2] have been selected for the TOOL SELECTION in the LOCAL MENU.

If the marking roller has been selected, F (start correction) and E (end correction) are not displayed.

```
[REMOTE]           0 KB
TANGENTIAL BLD
S 50 P 1500 R 0.30
H 30 F 0.00 E 0.0
```

S:Cutting speed P:Cutting pressure
R:Rounding-off distance H:Cutter lifting angle
F:Start correction E:End correction

When selecting a pen

This REMOTE screen appears when [HEAD : A] and [TOOL : PEN] have been selected for the TOOL SELECTION in the LOCAL MENU.

```
[REMOTE]           0 KB
PEN
S 50 P 200
```

S:Cutting speed P:Cutting pressure

When selecting an eccentric cutter

This REMOTE screen appears when [HEAD : A] and [TOOL : ECCENTRIC CUTTER] have been selected for the TOOL SELECTION in the LOCAL MENU.

```
[REMOTE]           0 KB
SWIEVEL BLD
S 50 P 120 O 0.30
```

S:Cutting speed P:Cutting pressure
O:Offset value

MATCHING THE FUNCTIONS OF THE DEVICE TO THE SPECIFICATIONS OF THE COMPUTER

The following explains how to set the functions required to connect the device to your personal computer.

Setting communication conditions [INTERFACE]

Communication conditions for the communication between the device and the computer to which the device is connected by way of RS232C.

Set values

Baud rate: 1200, 2400, 4800, 9600, 19200 (bps)
 Data bit: 7, 8 (bit)
 Parity: NO PARITY, EVEN, ODD
 Stop bit: 1, 2, (bit)
 Handshake: Hardware, X code, ENQ/ACK, software

1. Press the  key several times until the LCD indicates page 3 of the LOCAL MENU.

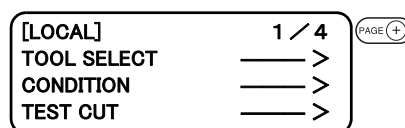

2. Select the [INTERFACE] from the menu.

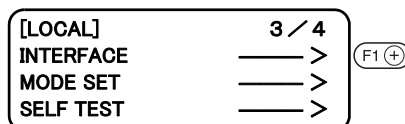

3. Set the [BAUD RATE] to a desired value.

The value marked with an asterisk (*) is the current set value.
 1200, 2400, 4800, 9600, 19200 (bps)



4. Set the [DATA BIT] to one of the following.

7, 8 (bit)



5. Press the  key until the LCD indicates page 2 of the [INTERFACE].



6. Set the [PARITY] to one of the following.

NO PARITY, EVEN, ODD

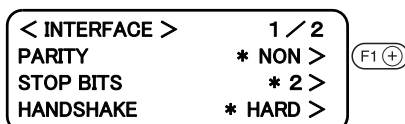

7. Set the [STOP BIT] to one of the following.

1, 1.5, 2 bit

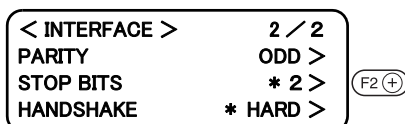

8. Set the [HAND SHAKE] to one of the following.

Hardware, X code, ENQ/ACK, software.

To return to the previous page, press the  key.

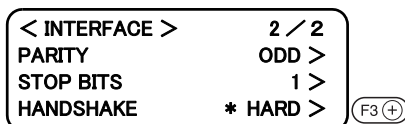

9. Enter the input values.

Press the **END** key to enter the input values.

If you do not enter the input data, press the **CE** key.

< INTERFACE >	2 / 2	END
PARITY	ODD >	
STOP BITS	1 >	
HANDSHAKE	XCODE >	



[[LOCAL]	3 / 4
INTERFACE	_____ >
MODE SET	_____ >
SELF TEST	_____ >

Setting the commands to be used [MODE SET] > [COMMAND]

Specify commands that are used by CAD.

Commands that can be selected are MGL-IIC3.

Set values

Command: MGL-IIC3

1. Press the **PAGE (+)** key several times until the LCD indicates page 3 of the LOCAL MENU.

[[LOCAL]	1 / 4	PAGE (+)
TOOL SELECT	_____ >	
CONDITION	_____ >	
TEST CUT	_____ >	

2. Select the [MODE SET].

[[[LOCAL]	3 / 4	F2 (+)
INTERFACE	_____ >	
MODE SET	_____ >	
SELF TEST	_____ >	

3. Press the **PAGE (+)** key several times until the LCD indicates page 4 of the [MODE SET].

< MODE SET >	1 / 6	PAGE (+)
Z STROKE	* 7 >	
MULTI-PASS	_____ >	
RESERVE		



[< MODE SET >	3 / 6
ROTATE	**+90° >
COMMAND	MGL-IIC3 >
CMD SW	*INVALID >

Rendering the set values on the personal computer effective
[MODE SET] > [COMMAND SW]

The set values that are rendered effective are specified either those set on the operation panel or those set on the CAD.

Set values

VALID: If items that are set on the operation panel of this device can also be set on the CAD, the latest command specified is given priority. If the device receives data set on the CAD after the data have been set on the operation panel, the data received will be given priority.

INVALID: The value that are set on the operation panel of the device are given priority while ignoring the value set on the CAD.

1. Press the  key several times until the LCD indicates page 3 of the LOCAL MENU.

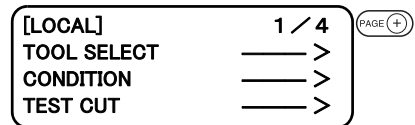

2. Select the [MODE SET].

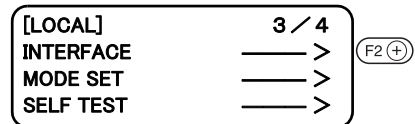

3. Press the  key several times until the LCD indicates page 4 of the [OPERATION MODE].

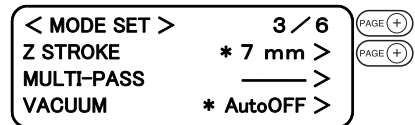

4. Set the [ORIGIN].

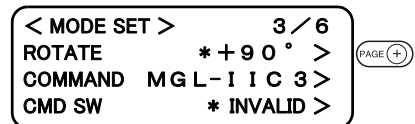

5. Enter the input values.

Press the  key to enter the input values.

If you do not enter the input data, press the  key.

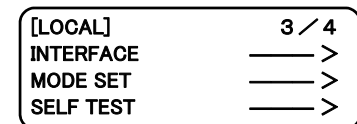
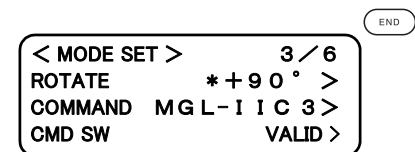

Setting the response value with respect to the valid area [MODE SET] > [OH UNIT]

The response value that is to be transmitted to the CAD in response to a valid area coordinate output command for the device is selected between the following.

Set values

INITIAL VALUE: The value of the max. valid cutting area of the device is transmitted to CAD.

SET VALUE: The value set in the "Setting the cutting area" on the LOCAL MENU.  P. 2-33

1. Press the  key several times until the LCD indicates page 3 of the LOCAL MENU.

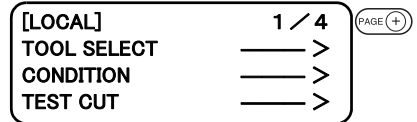

2. Select the [MODE SET].

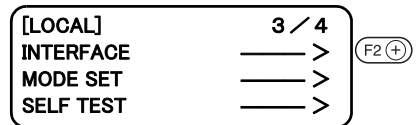

3. Press the  key several times until the LCD indicates page 4 of the [MODE SET].

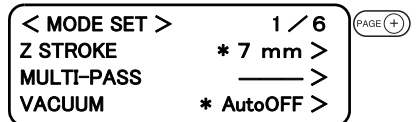

4. Set the [OH UNIT] to one of the following.

Press the  key to change the selected item alternately.

INITIAL VALUE, SET VALUE

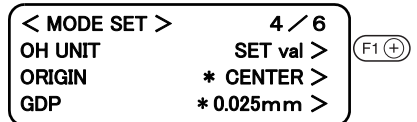

5. Enter the input values.

Press the  key to enter the input values.

If you do not enter the input data, press the  key.

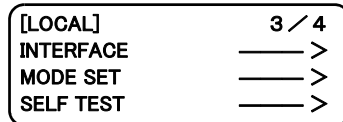
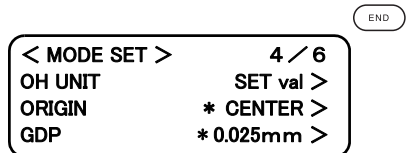

Setting the command origin [MODE SET] > [ORIGIN]

Adjust the position of the command origin of the device to the origin of the command origin of your CAD. Refer to the Instruction Manual for your CAD for the position of the command origin supported by the CAD.

Set values

LOWER LEFT: The command origin is set to the lower left of the maximum effective cutting area.

CENTER: The command origin is set to the center of the maximum effective cutting area.

1. Press the **(PAGE+)** key several times until the LCD indicates page 3 of the LOCAL MENU.

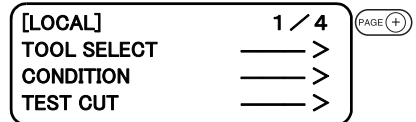

2. Select the [MODE SET].

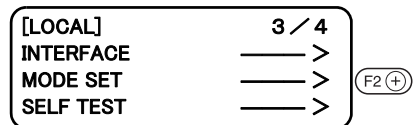

3. Press the **(PAGE+)** key several times until the LCD indicates page 4 of the [OPERATION MODE].

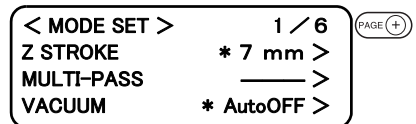

4. Set the [ORIGIN].

Press the **(F2+)** key to change the selected item alternately.
LOWER LEFT, CENTER

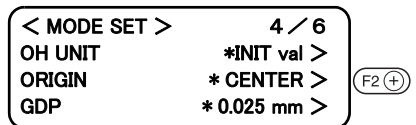

5. Enter the input values.

Press the **(END)** key to enter the input values.

If you do not enter the input data, press the **(CE)** key.

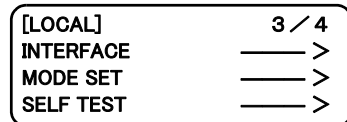
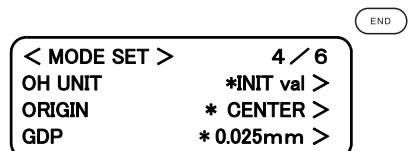

Setting the resolution (GDP) [MODE SET] > [GDP]

Set the resolution of the device to that of your CAD. Refer to the instruction manual for your CAD for the resolution supported by the CAD.

GDP: Graphic Display Pitch

Set values

0.025 mm : The resolution is set to 0.025 mm.

0.010 mm : The resolution is set to 0.010 mm.

1. Press the  key several times until the LCD indicates page 3 of the LOCAL MENU.

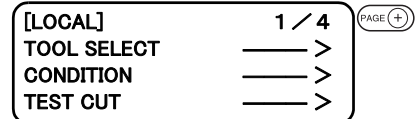

2. Select the [MODE SET].

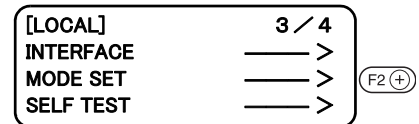

3. Press the  key several times until the LCD indicates page 4 of the [MODE SET].

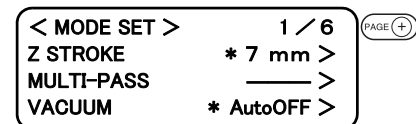

4. Set the [GDP] to on of the following.

Press the  to change the selected item alternately.

0.025mm, 0.010mm

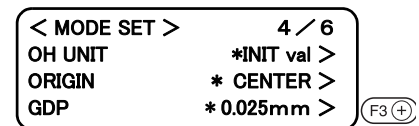

5. Enter the input values.

Press the  key to enter the input values.

If you do not enter the input data,

press the  key.

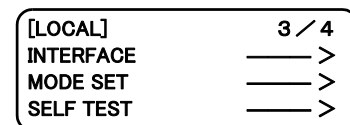
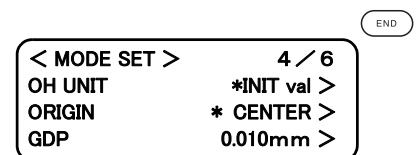

SETTING FOR AUTOMATIC HEAD RETRACT [AUTO VIEW]

A period of time required to cause the head to start to travel to its retracted position after the completion of cutting (plotting).

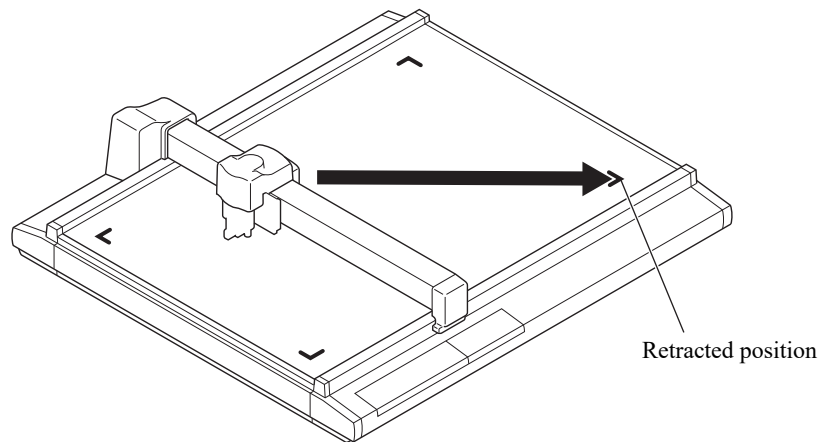

Set values

OFF: Automatic head retract is not performed.

1s: When one second has passed after the completion of cutting (plotting), the head starts to travel to the retracted position

3s: When three second has passed after the completion of cutting (plotting), the head starts to travel to the retracted position

1. Press the **(PAGE+)** key several times until the LCD indicates page 3 of the LOCAL MENU.

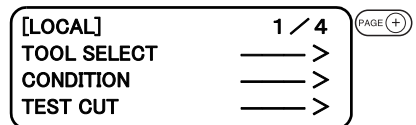

2. Select the [MODE SET].

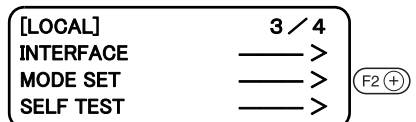

3. Press the **(PAGE+)** key until the LCD indicates page 2 of the [MODE SET].

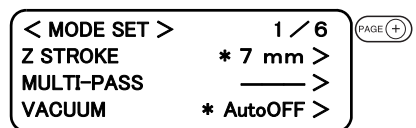

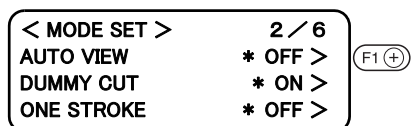

4. Set the [AUTO VIEW] to one of the following.

OFF, 1s, 3s



5. Enter the input values.

Press the  key to enter the input values.

If you do not enter the input data, press the  key.



- If the mark detect is set to ON (see P. 5-11), automatic head retract setting becomes OFF



< MODE SET >	2 / 6
AUTO VIEW	1 s >
DUMMY CUT	* ON >
ONE STROKE	* OFF >



[LOCAL]	3 / 4
INTERFACE	—— >
MODE SET	—— >
SELF TEST	—— >

AUTO-OFF FEATURE OF THE VACUUM

The validity of the Auto-OFF feature can be set up.

When the automatic head retraction function is set to 1s or 3s, the vacuum will turn off automatically after the head retracts.

When the automatic head retraction function is off, the vacuum will not turn off automatically.

While operating copy function, number cut function, or completing continuous square mark copy, will turn the vacuum off automatically, regardless of the automatic head retraction function.



- To use the vacuum function, Blower (available as option) is needed.

Auto-OFF/Panel-OFF[MODE SET]>[VACUUM]

1. Press the **PAGE(+)** key several times until the LCD indicates page 3 of the LOCAL MENU.

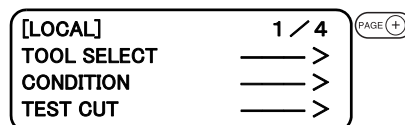

2. Select the [MODE SET].

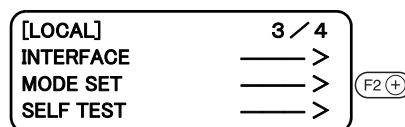

3. Select [VACUUM].

Auto OFF, Panel OFF

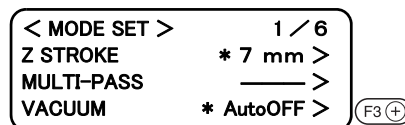

4. Register the setting.

Push on the **END** key to register the setting. When not registering, push on the **CE** key.

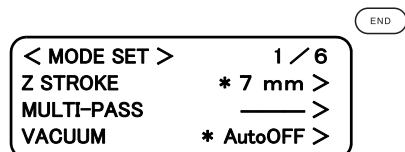



CHAPTER 2

BASIC OPERATION

In Chapter 2, normal operation of the device such as the attaching of tools or works.













Table of Contents

<i>BASIC OPERATION ON THE LOCAL MENU</i>	2-2
<i>BASIC OPERATION FLOW CHART</i>	2-5
<i>MOVING THE HEAD</i>	2-6
<i>FIXING A WORK</i>	2-8
<i>ADJUSTING THE BLADE</i>	2-10
<i>ATTACHING THE TOOLS</i>	2-12
<i>ADJUSTING THE HEIGHT OF THE HEAD</i>	2-16
<i>SELECTING A TOOL [TOOL SELECT]</i>	2-18
<i>SETTING CUTTING CONDITIONS [CONDITION]</i>	2-19
<i>CHECKING CUTTING CONDITIONS [TEST CUT]</i>	2-25
<i>SETTING THE CUTTING AREA [CUT AREA]</i>	2-33
<i>SETTING THE ORIGIN (ORIGIN FOR PLOTTING)</i>	2-36
<i>INTERRUPTION OF PROCESSING (PLOTTING, CUTTING OR CREASING)</i>	2-37

BASIC OPERATION ON THE LOCAL MENU







LOCAL menu

Various kinds of data and functions required for the connection with your personal computer are set.

Function	Description	Reference page
TOOL SELECTION	Head and tool to be used are selected.	 P. 2-18
CONDITIONS	Conditions for the tool selected using the [TOOL SELECTION] function are specified.	 P. 2-19
TEST CUT	Test cutting is performed so as to check that the settings specified using the [CUTTING CONDITIONS] function are proper.	 P. 2-25
DATA CLEAR	Data received are cleared when aborting the cutting (plotting) or in prior to the execution of the [COPY] function.	 P. 2-37
ORGkey to SC.CLR	Clear the mark scale correction.	 P. 5-18
COPY	Cutting is performed again in accordance with the data that have been once received.	 P. 4-4
VIEW	The head is moved to the head retracting position located at the lower right of the cutting area or to the lower left of the cutting area.	 P. 2-6
INTERFACE	Communication conditions for the serial port that matches the personal computer to be used are established.	 P. 1-19
MODE TEST	Settings required to match the device to the personal computer or application functions are specified.	 P. 2-2
SELF TEST	Cutting is performed in accordance with sample data so as to check the cutting quality or whether the device itself has failed. In addition, data are plotted using ASCII code or set values (parameters) for this device are plotted as as to check for abnormal data.	 P. 6-2
CUT AREA	Size of a work attached on the device or an area for cutting is specified.	 P. 2-33
AXIS ALIGN	If ruled lines such as scales are printed, mechanical axes (X-axis, Y-axis) of the device are aligned to them.	 P. 4-13
TOOL ADJUST	Tools and relation between tools are adjusted. Adjust Light pointer position is adjusted.	 P. 3-6

MODE SET menu

The following explains functions of the [MODE SET] in the LOCAL menu.

Function	Description	Reference page
COMMAND	Establish commands and input codes for your CAD. (For the CF2, only MGL-IIC3 is available)	 P. 1-24
UNIT	The unit to be used when indicating numerics on the LCD is specified.	 P. 4-11
AUTO VIEW	A period of time from the completion of cutting (plotting) to the start of head retraction is specified.	 P. 1-25
ONE STROKE	To eliminate a portion that remains uncut, unnecessary vertical motion of the cutter is omitted to permit single-stroke cutting.	 P. 4-8
GDP	Resolution is adjusted to the one supported by your CAD.	 P. 1-24
ORIGIN	A command origin is established that matches your CAD.	 P. 1-23

Z STROKE	The height of the tool, in its lifted position, from the surface of a work to the bottom of tool is specified.	P. 4-10
OH UNIT	A value that is transmitted to the computer in return to the command for the output of effective area coordinate of the device.	P. 1-21
ROTATE	A direction in which data transmitted from application software are to be turned by 90 is specified.	P. 4-9
COMMAND SW	The set values that are rendered effective are specified either those set on the operation panel or those set on the personal computer.	P. 1-20
PEN ASSIGN	Pen numbers included in data are assigned to tools of the device.	P. 4-2
MULTI-PASS	The number of times to perform cutting is set when cutting a work that cannot be cut by performing cutting once.	P. 4-6
VACUUM	Setup the validity of the auto-off function.	P. 1-27
EXPAND	When Mark sensor is not used, expand the cut area of x-axis up to 30mm	P. 4-15
MARK SENSOR	Set up the register mark detect setting	P. 5-10

Basic operation on the LOCAL menu

The following describes basic operating procedure to be followed to set the LOCAL menu.

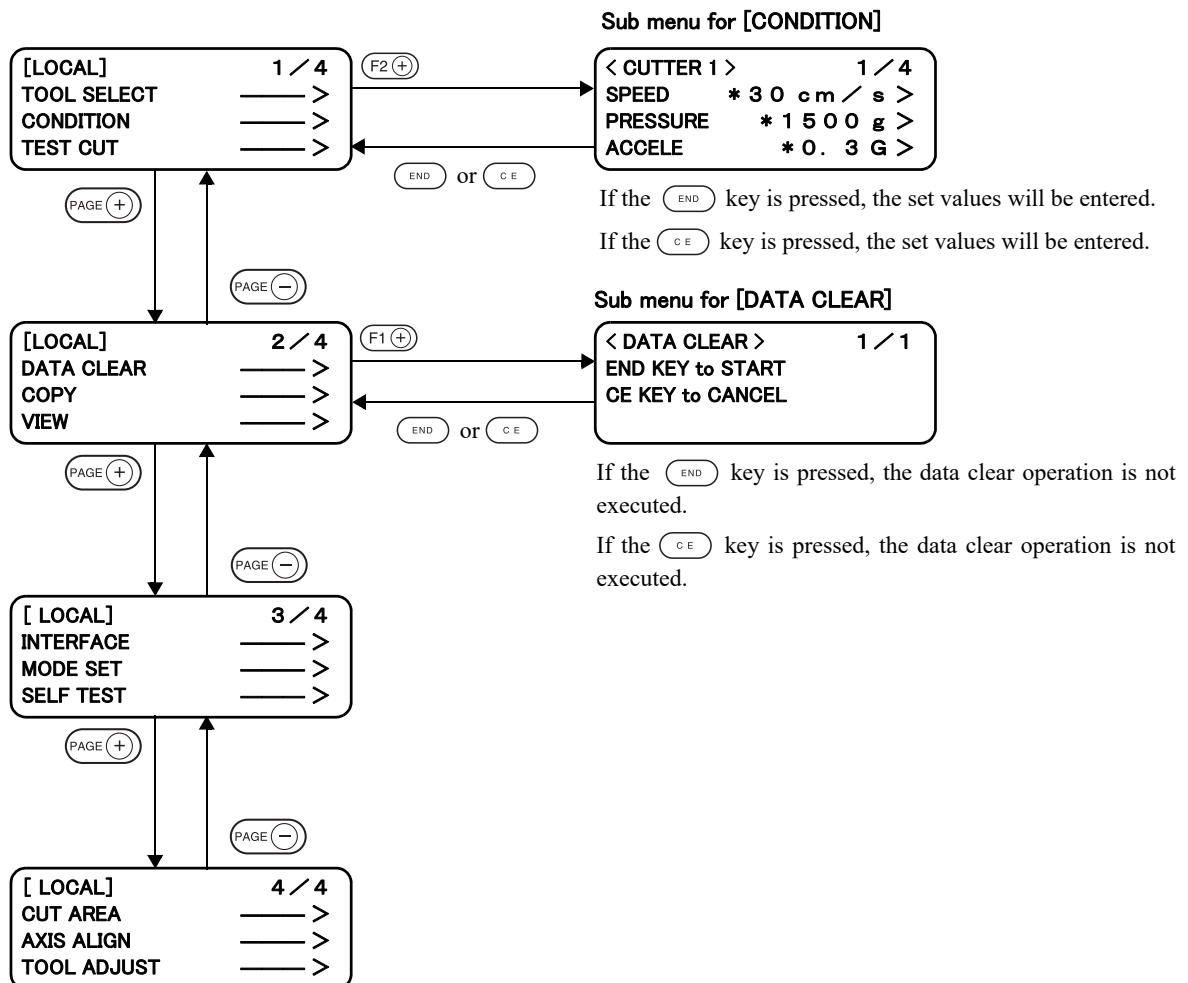

1. Set the device in the LOCAL mode.







Check first that no data received remain, and press the  key to set the device in the LOCAL mode.



2. Advance the LOCAL menu pages.

Each press on the  key will advance the page one by one.

Each press on the  key will return the page one by one.



3. Select the setting item.



Select the setting item using the six function keys,  or ,  or ,  or . The corresponding sub menu appears on the LCD.

The + keys (,  and  keys) of the function keys are used in this explanation.

4. Input a set value.

Change the set value using the six function keys that are shown on the right of each item.

If the ,  or  key is pressed, the next value will appear on the screen.

If the ,  or  key is pressed, the previous value will appear on the screen.

5. Save the set values.

Press the  key, and the LOCAL menu will be restored on the screen.

To cancel the set values:

Press the  key, and the previous indication screen will be restored without saving the set values.

BASIC OPERATION FLOW CHART

The following is the basic operation flow chart.
Refer to the page to be referred to for detailed explanation of each operation.

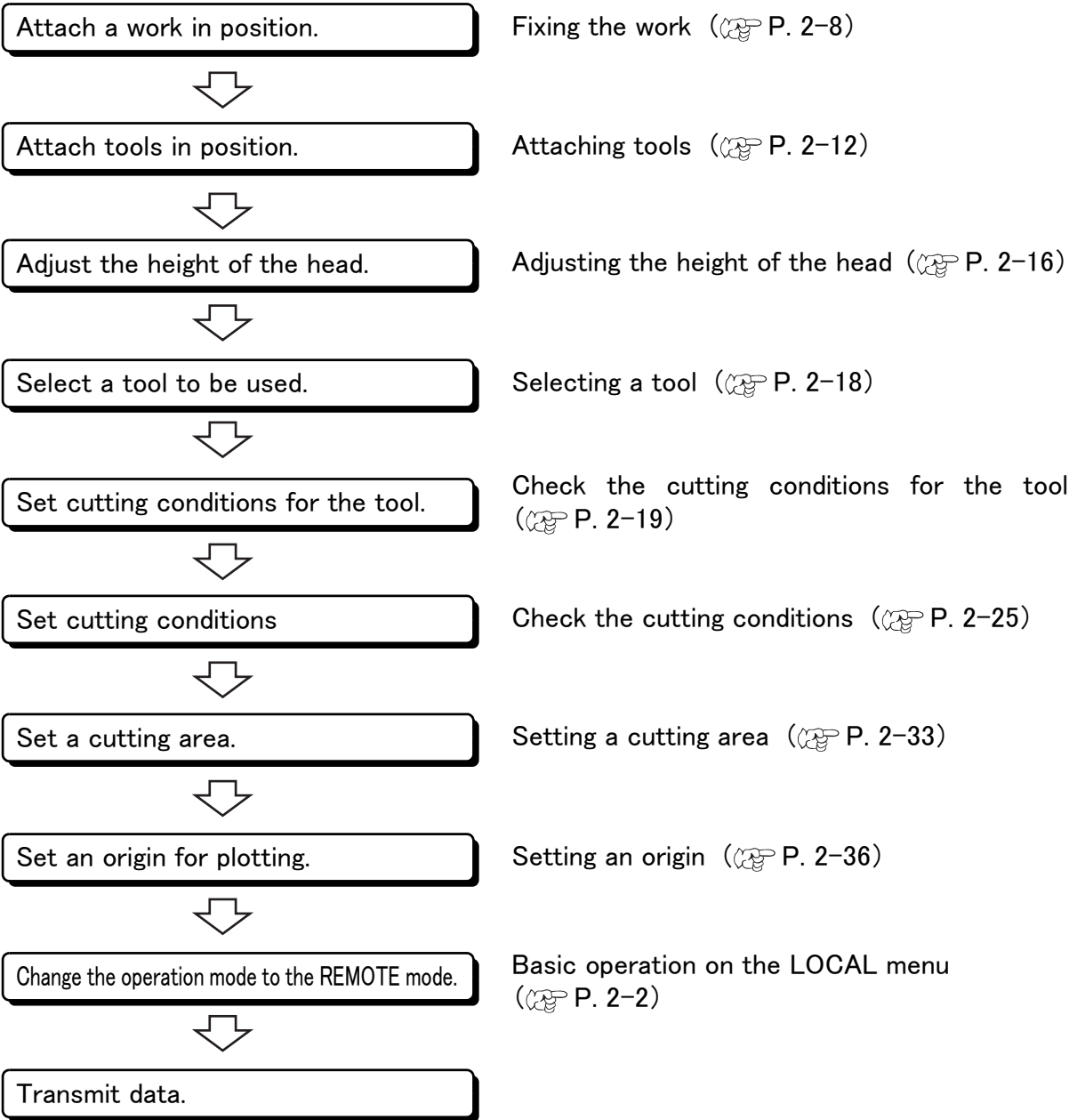

MOVING THE HEAD

It is possible to move the head for easier operation when attaching a tool or a work on the device or executing test cut. The head can be moved in the following two different procedures:

- Moving the head by “VIEW” function
- Moving the head by the jog keys

Moving the head by “VIEW” function

This function works to move the head in one stroke to the lower left point or the retracting point (lower right) of the cutting area. This function is used when the head rests inside the cutting area to hinder the works.

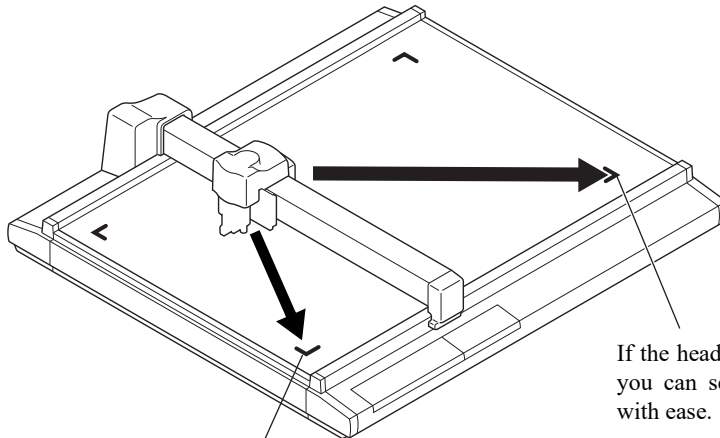

If the head is retracted to this point, you can set a tool with ease.

If the head is retracted to this point, you can set a work on the device with ease.



- If the “VIEW” (👉 P. 1-25) is specified, the head will automatically move to the retracting point after the completion of cutting (plotting). This omits the execution of the “VIEW” function.

1. Press the **PAGE (+)** key several times until the LCD indicates page 3 of the LOCAL MENU.

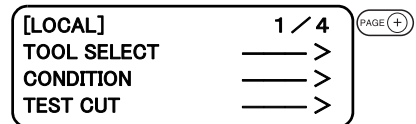

2. Select the [VIEW].

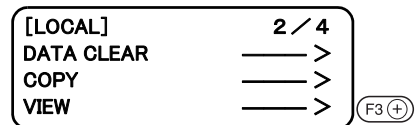

3. Select a point to which the head is moved to.

Press the **(F1 +)** key to move the head to the retract point at the lower left of the cutting area.

Press the **(F2 +)** key to move the head to the retract point at the lower right of the cutting area.

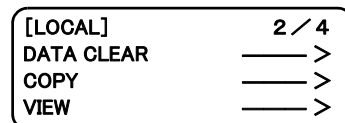
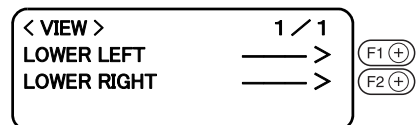

Moving the head by the jog keys

Follow this procedure when attaching a tool or executing test cut or sample cut.

Press a jog key to select the jog mode, and the following two functions can be carried out to move the head to a desired position with accuracy.

- Moving speed of the head (high-speed, medium-speed, low-speed, or Auto)
- Moving the tool up/down

Coordinates as from the command origin are indicated on the coordinate indicating portion of the screen.

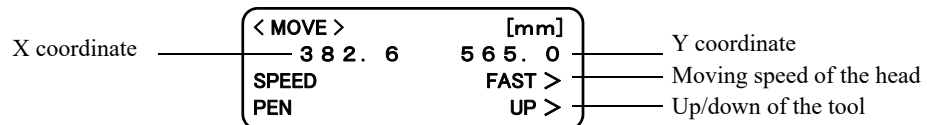

1. Invoke the LOCAL menu on the screen.

If the device is in the REMOTE mode, press the  key to select the LOCAL mode.

You may open any page of the menu from among pages 1 to 4.

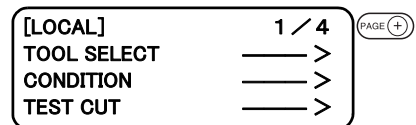

2. Press one of the jog keys once.

The device enters the travel mode.

Coordinates of the tip of tool that is currently specified are displayed.

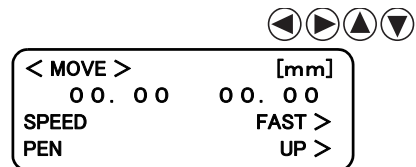



3. Move the head by the jog keys.

Coordinates of the tip of tool that is currently specified are displayed.

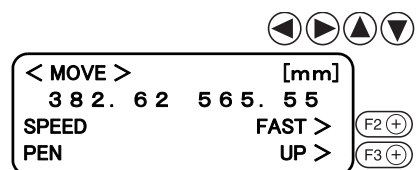
Change the moving speed or move up/down the tip of tool when necessary.



4. Exit from the travel mode.

Press the  key or the  key.

This restores the procedure 1 on the screen.

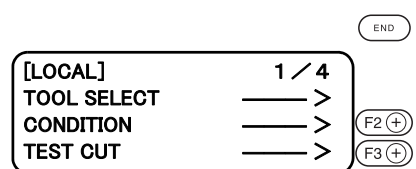

FIXING A WORK

A work can be fixed on the device following one of the two procedures described below.

- Fixing the work with vacuum
- Fixing the work with adhesive tape



- Thickness of works that can be attached on this device should not exceed 25mm.

Four area marker labels are adhered on the cutting panel. The area within the labels is the maximum effective cutting area in which cutting can be performed. Fix a work within this area.

Cutting cannot be mechanically performed in any area outside the area marker labels.

Fixing a work that is comparatively light in weight

A work that is comparatively light in weight such as thin coated board or corrugated fiberboard is vacuum-sucked for the securing.



- Optional blower is required to use the vacuum function.



- If a work is too small to cover all suction holes, cover all the holes with a sheet.
- If any of the suction holes is not covered, the suction force will decrease to fail to secure the work.

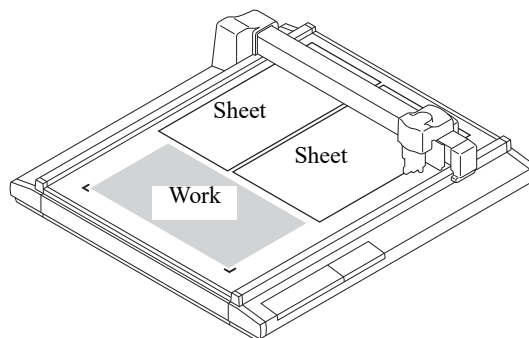

1. Place a work on the cutting panel.

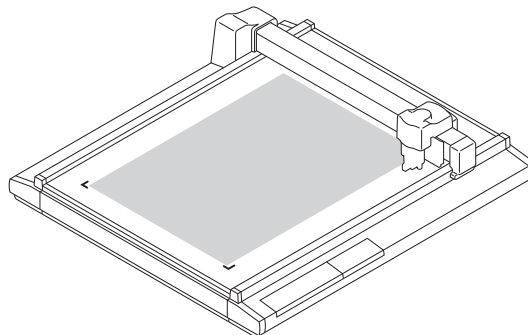



- By aligning the media edge to the media guide, work can be set straight. Be sure to set the work within the Maximum effective cutting area.
- When EXPAND is set to ON with a sensor model or No sensor model, work guide may interrupt the maximum cutting area. Remove either work guide plate, or work guide pin.

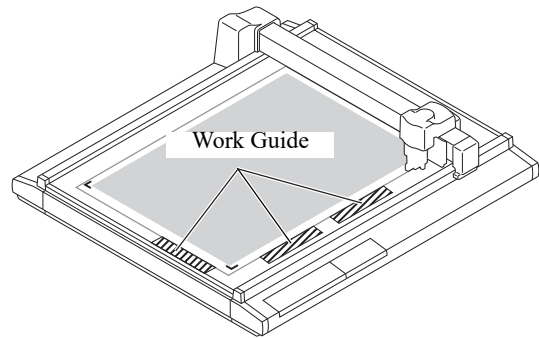

2. Press the  VACUUM key.

The VACUUM lamp lights up (in green).

The vacuuming unit actuates to pick the work by suction.



Fixing heavy-weight packing etc.

A work such as a heavy-weight packing or industrial rubber may not be sufficiently secured by vacuum-suction. In this case, secure the work with adhesive tape.



- Use such adhesive tape that adhesive glue or tape will not remain on the cutting panel.

1. **Fix four sides of the work with adhesive tape.**

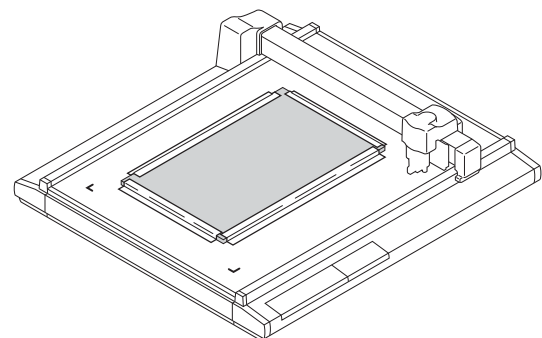

ADJUSTING THE BLADE

Adjusting procedure for the blade of the tangential cutter and the swivel cutter is given below.

Tangential cutter

Follow the procedure described below when projecting the blade tip of carbide blade 30° and highspeed steel blade 30°.

Carbide blade 30° For hard works such as industrial rubber and packings

High-speed steel blade 30° For light-weight and soft works such as coated board and corrugated fiberboard.



- Special blades and holders for tangential cutters are prepared in accordance with works. Please contact your local dealer or MIMAKI office for details.

1. Loosen the dial stopper.

Loosen the dial stopper counterclockwise to loosen it.

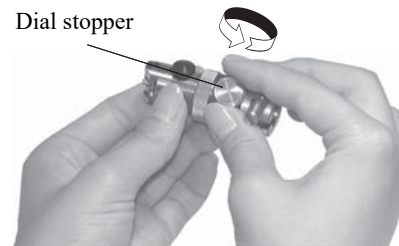

2. Turn the dial.

If you turn the dial in the direction of the arrow, the blade tip will protrude by 0.1 mm.

Projecting amount of the blade tip to be used as a guide:

Thickness of work + 0.2 mm

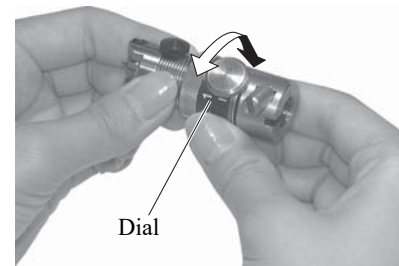

3. Pressing the dial in the direction of the arrow, tighten the dial stopper.



- The dial has a play. To eliminate an error in the projecting amount of the blade tip, tighten the dial stopper while keeping the dial held pushed in the direction of the arrow.

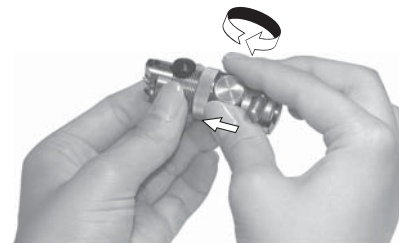

Swivel blade

Follow the procedure described below when projecting the blade tip of the swivel cutter.



- Special blades for the swivel cutters are prepared in accordance with works. Please contact your local dealer or MIMAKI office for details.

1. Loosen the locknut.

Loosen the locknut counterclockwise to loosen it.

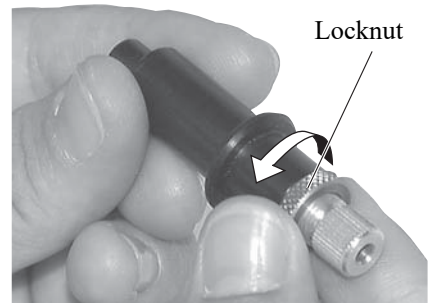

2. Turning the adjusting knob, adjust the projecting amount of the blade tip.

Turn the adjusting knob clockwise to project the blade tip.

Turn the adjusting knob counterclockwise to retract it into the holder.

Projecting amount of the blade tip to be used as a guide:

Thickness of work + Thickness of base sheet/2

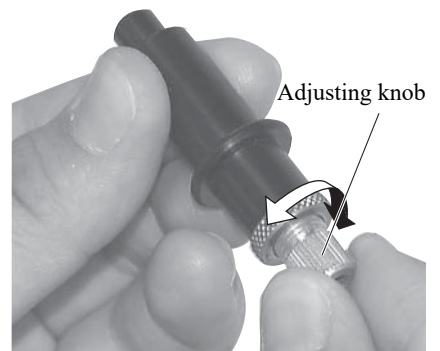

3. Taking care not to allow the adjusting knob to turn, tighten the locknut.

Turn the locknut clockwise to tighten it.

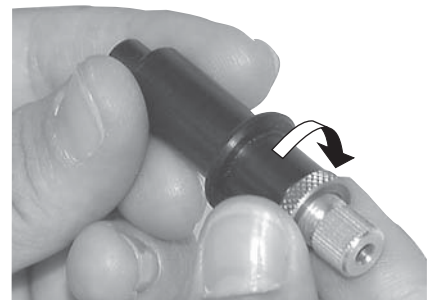

ATTACHING THE TOOLS

The table below gives the heads (A, B and C) to which tools are attached with respect to the head models.



This picture shows TD-head model.

Head model name	T-head	TD-head	TF-head
Pen	A		
Swivel blade	A		
Low-pressure tangential cutter	B	B	B
High-pressure tangential cutter	-	C	C
Creasing roller	-	C	-

Attaching the pen and the swivel blade

If the head is in the lower position and a tool cannot be installed, lift the head. (P. 2-16)

1. Loosen the screw in head A.

Turn the screw A counterclockwise to loosen it.
Open the holder right and left.

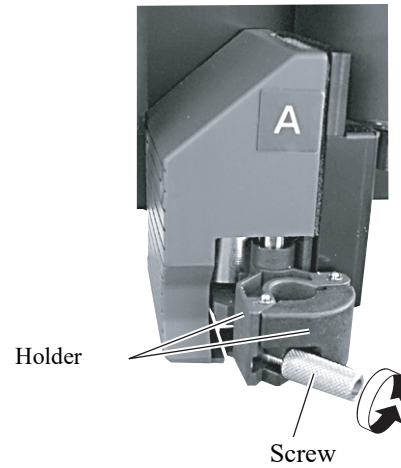

2. Insert the plotter pen or the swivel blade in head A.

Fit the collar of the pen or the swivel blade in the groove in the holder.

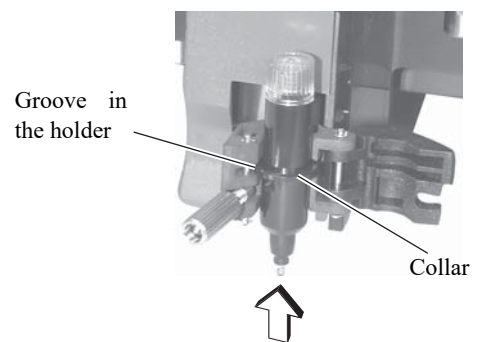

3. Tighten the screw in head A.

Close the holders and turn the screw clockwise.
If the screw is securely tightened, normal product quality cannot be obtained.

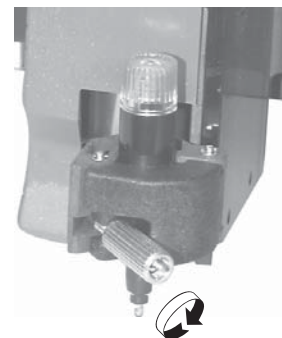

Attaching the tangential cutter

Tangential cutter can be used with the head models excluding the P-head model.

If the head is in the lower position and a tangential cutter cannot be installed, lift the head. (☞ P. 2-16)

1. Loosen the stopper screw in the tangential cutter.

Turn the stopper screw counterclockwise to loosen it.

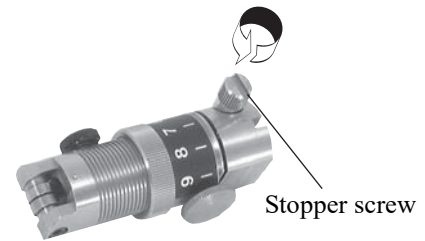

2. Insert the pin of head B into the tangential cutter while fitting the pin in the groove on the cutter.

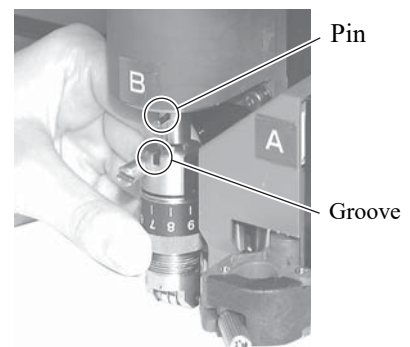

3. Tighten the stopper screw with the screwdriver supplied with the device as an accessory.

Securely fix the cutter holder.

If it is not securely fixed, normal product quality cannot be achieved.



Installing the crease roller

The creasing roller can be installed on the head models excluding the P- and T-head models.

The crease roller is attached to C of the TD-head model. The high-pressure tangential cutter can also be attached to it.

If the head is in the lower position and the crease roller cannot be installed, lift the head. (P. 2-16)

1. Loosen the stopper screw in the crease roller.

Turn the stopper screw counterclockwise to loosen it.

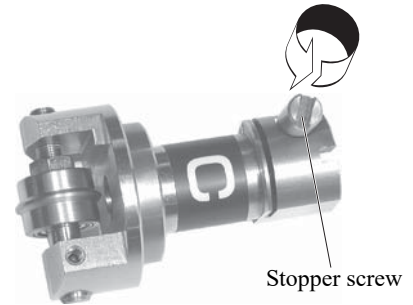

2. Insert the pin of head C into the marking roller while fitting the pin in the groove on the roller.



3. Tighten the stopper screw with the screwdriver supplied with the device as an accessory.

Securely fix the cutter holder.

If the stopper screw is not securely tightened, normal product quality cannot be achieved.

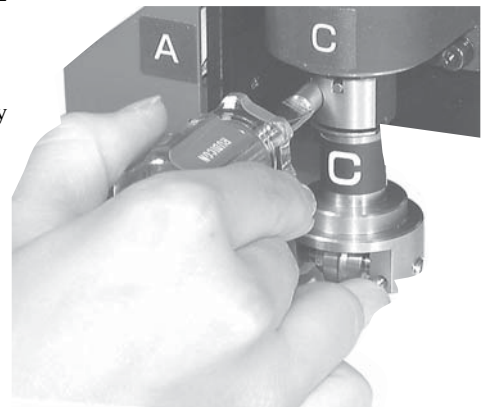

ADJUSTING THE HEIGHT OF THE HEAD

After a work and the tools have been properly attached in position, adjust the height of the head in accordance with thickness of the work.

Be sure to adjust the height of the head whenever you have changed a work to be used.



- When lifting the head, be sure to support the head base by hand. If lifting the head only by the height adjusting knob, the height adjusting knob can break.
- Be sure to tight the both fixing screws alternately. If not, the fixing screws may be broken.

1. Loosen two fixing screws in the head.

Turn the fixing screws counterclockwise to loosen them.

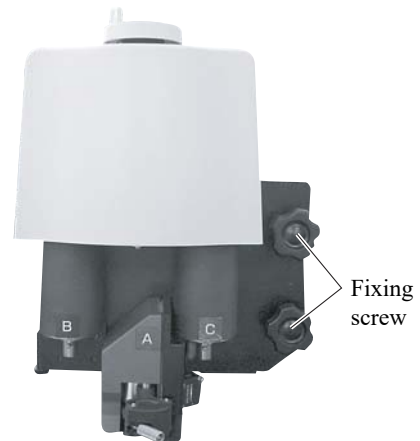

2. Raise the head using the height adjusting knob.

Turn the height adjusting knob counterclockwise to lift the head.



- Since the head is heavy in weight, support the head base by hand. If not, the knob can break.

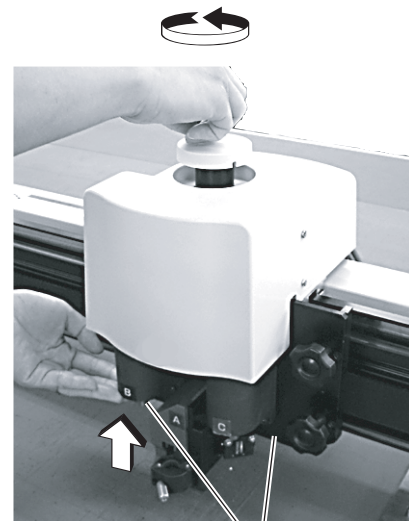

Head base

3. Pressing down the height adjusting bar, turn the height adjusting knob to lower the head.

Lower the head until the bottom end of the adjusting bar comes in contact with the top surface of the work.

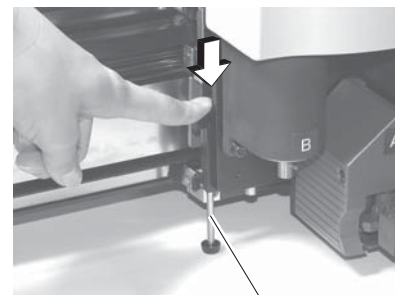

Height adjusting bar

- 4. Tight the both fixing screws on the head alternately from the bottom screw first.**

Turn the fixing screws clockwise to tighten them.



SELECTING A TOOL [TOOL SELECT]

Now, select a head and a tool to be used in the cases described below.

- In the case where the pen number cannot be specified on the CAD.
- In the case where [TEST CUT] function or [SELF TEST] function is executed on the device itself
- In the case where the [COMMAND SW] is set to “invalid” in the OPERATION mode

Tools that can be separately set for each head are as follows:

Head	A	B	C	
Tool	Pen / Swivel blade	Cutters 1 to 2	Rollers 1 to 4 / R. cutters 1 to 2	Cutters 1 to 2
T-head model	○	○	—	—
TD-head model	○	○	○	—
TF-head model	○	○	○*1	—

*1 : The TF-head model is not supplied with a crease roller. So, do not select any of rollers 1 to 4 for the TF-head model. R. cutters 1 and 2 are intended for high pressure.

The following describes how to set the head from pen A to cutter B and the tool to cutter 2.

1. Press the **(PAGE+)** key several times until the LCD indicates page 3 of the LOCAL MENU.

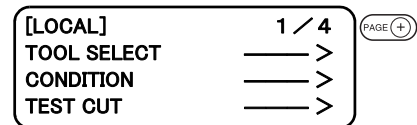

2. Select the [TOOL SELECT].

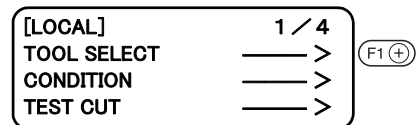

3. Select the head to be used in the operation

Every time the **(F1+)** key is pressed, the selected head will change.

A, B, C

Heads that can be selected differ with the head models.

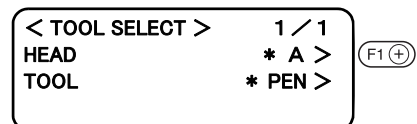

4. Select the tool to be used.

Cutter 1, Cutter 2

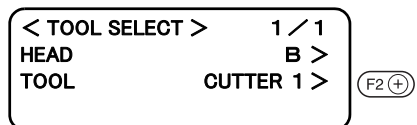

5. Enter the input values.

Press the **(END)** key to enter the input values.

key to enter the input values.If you do not enter the input data, press the

(C.E) key.

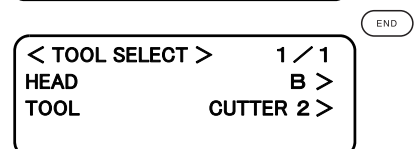

SETTING CUTTING CONDITIONS [CONDITION]

Cutting conditions are set for the tool that has been selected in the [TOOL SELECT].

Setting items

Cutting condition setting items differ with the tools.

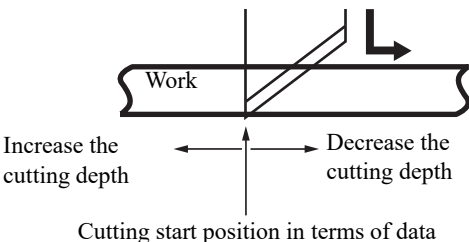
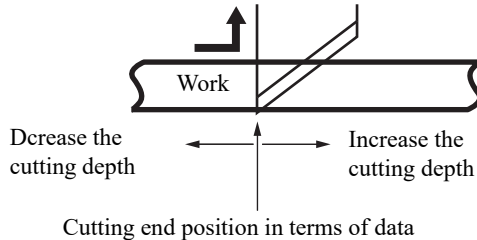

- In the case Approximate Type is set to “Arc” on the FineCut plotter setting, excessive pressure may applied and damage the cutter depend on the media type. When set to “Arc”, be sure to readjust the cut condition of FineCut or set the [R speed] on the plotter. When [R speed] is set, [R speed] value is given priority over the FineCut speed setting.

Setting item	Description	Pen	Tangential cutter	Crease roller	Swivel blade
Speed	The speed at which the tool moves.	○	○	○	○
Pressure	A pressure that is applied by the tool to a work.	○	○	○	○
Accele	The max. acceleration specified for the tool. Change the acceleration in accordance with the types of tools and works to be used as well as data sizes.	○	○	○	○
Offset	Offset amount of the blade tip of the swivel blade is specified. Change the offset in accordance with the work thickness and wear of the blade tip.				○
Front offset	The amount of correction of the position from which cutting starts when the tool comes down. For heavy-weight materials, the amount of correction should be increased. This will cause the cutter to start cutting from this side of the predetermined start position, thereby allowing easy cut-out of the work. Adjust the start position while checking the finished state of products. 		○		
End offset	The amount of correction of the position at which cutting ends when the tool goes up. For heavy-weight materials, the amount of correction should be increased. This will cause the cutter to finish cutting at a position that goes beyond the predetermined cutting end position, thereby allowing easy cut-out of the work. Adjust the start position while checking the finished state of products. 		○		

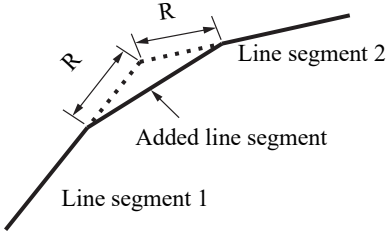
Setting item	Description	Pen	Tangential cutter	Crease roller	Swivel blade
Up angle	The minimum angle required by the raised tool to change the direction of cutting (marking). This reduces the degree by which the tool pries the work.		<input type="radio"/>	<input type="radio"/>	<input type="radio"/>
Ring distance	If minute line segments continue, a rounding distance (R) is provided between each two of the line segments to add another one. 		<input type="radio"/>	<input type="radio"/>	
Press correction	The pressure applied to the tool at the time of descending is to be corrected when cutting (marking) heavy-weight works. The works can be cut without fail when the tool is lowered by adding a pressure correction value to the previously-set pressure value.		<input type="radio"/>	<input type="radio"/>	
Press (Y)	The pressure applied to the roller/cutter can be corrected in terms of Y-axis, to perform marking with a Y-axis pressure applied separately from an X-axis pressure. To mark a piece of corrugated fiberboard, it can be placed with its flutes oriented in the Y-axis for marking with a lighter pressure applied as compared with the X-axis.			<input type="radio"/>	
R5 speed	The speed that is employed when cutting an arc that is 5 mm or less in radius. If [OFF] is selected, the arc is cut at the previously specified speed.	<input type="radio"/>	<input type="radio"/>		
R10 speed	The speed that is employed when cutting an arc that is less than 5 mm or more and 10 mm or less in radius. If [OFF] is selected, the arc is cut at the previously specified speed.	<input type="radio"/>	<input type="radio"/>		
R15 speeds	The speed that is employed when cutting an arc that is 10 mm or more and less that 15 mm. If [OFF] is selected, the arc is cut at the previously specified speed.	<input type="radio"/>	<input type="radio"/>		
R20 speeds	The speed that is employed when cutting an arc that is 15 mm or more and less that 20 mm. If [OFF] is selected, the arc is cut at the previously specified speed.	<input type="radio"/>			
R30 speeds	The speed that is employed when cutting an arc that is 25 mm or more and less that 30 mm. If [OFF] is selected, the arc is cut at the previously specified speed.	<input type="radio"/>			
R40 speeds	The speed that is employed when cutting an arc that is 30 mm or more and less that 40 mm. If [OFF] is selected, the arc is cut at the previously specified speed.R50 speed.	<input type="radio"/>			

Setting item	Description	Pen	Tangential cutter	Crease roller	Swivel blade
R50 speeds	The speed that is employed when cutting an arc that is 40 mm or more and less than 50 mm. If [OFF] is selected, the arc is cut at the previously specified speed.R50 speed.	○			
R100 speeds	The speed that is employed when cutting an arc that is 50 mm or more and less than 100 mm. If [OFF] is selected, the arc is cut at the previously specified speed.R50 speed.	○			

Set values

Plotting conditions for pens

Set values for plotting conditions are given below.

Set values

Speed: 2, 5, 10, 15, 20, 25, 30, 35, 40, 45, 50 (cm/s)
 Pressure: 20 to 100 (in increments of 5 g)
 100 to 400 (n increments of 10 g)
 Acceleration: 0.1 to 0.5 (in increments of 0.1 G)
 R5 speed: Off, 1, 2 (cm/s)
 R10 speed: Off, 1, 2, 3, 4, 5 (cm/s)
 R15 speed: Off, 1, 2, 3, 4, 5, 10 (cm/s)
 R20 speed: Off, 1, 2, 3, 4, 5, 10, 15 (cm/s)
 R30 speed: Off, 1, 2, 3, 4, 5, 10, 15, 20 (cm/s)
 R40 speed: Off, 1, 2, 3, 4, 5, 10, 15, 20, 25 (cm/s)
 R50 speed: Off, 1, 2, 3, 4, 5, 10, 15, 20, 25, 30 (cm/s)
 R100 speed: Off, 1, 2, 3, 4, 5, 10, 15, 20, 25, 30 (cm/s)

Cutting conditions for the tangential cutter

The tangential cutter is applicable to the head models excluding the P-head. Set values for the tangential cutter are given below. The tangential cutter comes in two different types; the low-pressure cutter to be installed on head B and the high-pressure cutter to be installed on head C.

Set values

Speed: 2, 5, 10, 15, 20, 25, 30, 35, 40, 45, 50 (cm/s)
 Pressure: 300 to 1500 (in increments of 100 g) Low-pressure cutter
 1000 to 5000 (in increments of 100 g) High-pressure cutter
 Acceleration: 0.1 to 0.5 (in increments of 0.1 G)
 Start correction: 0.00 to 2.50 (in increments of 0.05 mm)
 End correction: 0.00 to 2.50 (in increments of 0.05 mm)
 Up angle: 0 to 180 (in increments of 1°)
 Ring distance: 0.00 to 2.50 (in increments of 0.05 mm)
 Press correction: 0 to 500 (in increments of 100 g)
 R5 speed: Off, 0.5 (mm/s), 0.1, 0.2, 0.5, 1.0, 2.0 (cm/s)
 R10 speed: Off, 0.5 (mm/s), 0.1, 0.2, 0.5, 1.0, 2.0 (cm/s)
 R15 speed: Off, 0.5 (mm/s), 0.1, 0.2, 0.5, 1.0, 2.0 (cm/s)

Marking conditions for the crease roller

The following gives set values for crease conditions for the crease roller.

Set values

Speed: 2, 5, 10, 15, 20, 25, 30, 35, 40, 45, 50 (cm/s)
Pressure: 1000 to 5000 (in increments of 100 g)
Acceleration: 0.1 to 0.5 (in increments of 0.1 G)
Up angle: 0 to 180 (in increments of 1°)
Ring distance: 0.00 to 2.50 (in increments of 0.05 mm)
Press correction: 0 to 1000 (in increments of 100 g)
Press (Y): -5000 to 5000 (in increments of 100 g)

Cutting conditions for the swivel blade

The following gives set values for cutting conditions for the swivel blade (optional).

Set values

Speed: 2, 5, 10, 15, 20, 25, 30, 35, 40, 45, 50 (cm/s)
Pressure: 20 to 100 (in increments of 5 g)
100 to 400 (in increments of 10 g)
Offset: 0.00 to 2.50 (in increments of 0.05 mm)
Acceleration: 0.1 to 0.5 (in increments of 0.1 G)

Setting cutting conditions

The following describes how to establish cutting conditions for cutter 2 (tangential cutter) as an example. Once you have set cutting conditions, execute the [TEST CUT] function to check whether or not the cutting conditions are proper. (P. 2-25)

1. Select the head and the tool in the [TOOL SELECT]. (P. 2-18)

Select B for the head and cutter 2 for the tool.

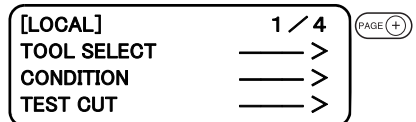

2. Invoke the 1st page of the LOCAL MENU.

3. Select the [CONDITION].

Select the CONDITION, and the cutting conditions for the cutter 2 will appear on the screen.

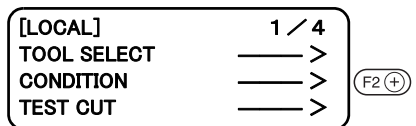

4. Set the speed, pressure and acceleration to adequate values.

F1 (+)Input a speed.

F2 (+)Input a pressure.

F3 (+)Input an acceleration.



- If the “- (minus)” key of the respective function keys is pressed, a previous value is indicated on the display.

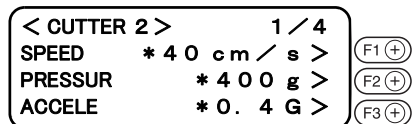

5. Invoke the 2nd page of the cutting conditions screen for cutter 2.

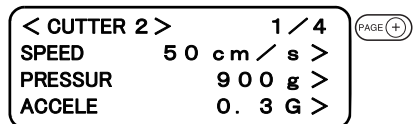

6. Set the [START CORRECTION],[END CORRECTION] and [UP ANGLE] to adequate values.

F1 (+)Input a start correction.

F2 (+)Input an end correction.

F3 (+)Input an up angle.



- If the “- (minus)” key of the respective function keys is pressed, a previous value is indicated on the display.

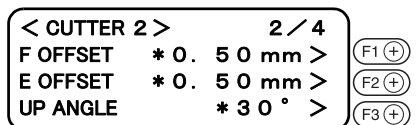

7. Invoke the 3rd page of the CUTTING CONDITIONS screen for cutter 2.

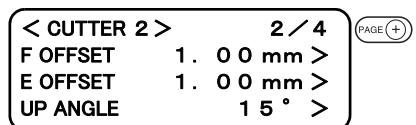

8. Set the RING DISTANCE and PRESS CORRECTION to adequate value.

F1(+) Input a ring distance.

F2(+) Input a press correction.



- If the “– (minus)” key of the respective function keys is pressed, a previous value is indicated on the display.

< CUTTER 2 >	3 / 4	
RING DIS	* 0. 3 0 mm >	F1(+)
PRESS COR	* 0 g >	F2(+)
RESERVE		

9. Invoke the 4th page of the CUTTING CONDITIONS screen for cutter 2.

< CUTTER 2 >	3 / 4	PAGE(+)
RING DIS	0. 1 0 mm >	
PRESS COR	1 0 0 g >	
RESERVE		

10. Set the SPEED, R10 SPEED and R15 SPEED.

F1(+) Input an R5 speed.

F2(+) Input an R10 speed.

F3(+) Input an R15 speed.



- If the “– (minus)” key of the respective function keys is pressed, a previous value is indicated on the display.

< CUTTER 2 >	4 / 4	
R 5 SPD	* OFF >	F1(+)
R 1 0 SPD	* OFF >	F2(+)
R 1 5 SPD	* OFF >	F3(+)

11. Enter the input values.

Press the **END** key to enter the input values.

If you do not enter the input data, press the **CE** key.

< CUTTER 2 >	4 / 4	END
R 5 SPD	0. 1 mm / s >	
R 1 0 SPD	0. 2 mm / s >	
R 1 5 SPD	0. 5 mm / s >	



[LOCAL]	1 / 4
TOOL SELECT	_____ >
CONDITION	_____ >
TEST CUT	_____ >

CHECKING CUTTING CONDITIONS [TEST CUT]

Whenever you have changed cutting conditions or the tool(s) to be used, execute the “test cut” function to check the following items. Refer to “Checking the status of tools” (☞ P. 2-27)

- (1) Whether or not the cutting (plotting) conditions are proper
Whether or not a work is properly cut or the finished plot has thin spots.
- (2) Whether or not the tool is off-center
If the tool is off-center, inaccuracy in cutting will result.
- (3) Whether or not the tools are matched to each other
If the plot is cut with a tangential cutter, check whether or not the cut pattern exactly matches the plot.

For the above-stated case (1), re-establish the cutting conditions. (☞ P. 2-19)

For the above-stated cases (2) or (3), correct the trouble through the “adjustment of the tools. (☞ P. 3-15)

The pattern for the test cut and the cutting (plotting) order is as follows:

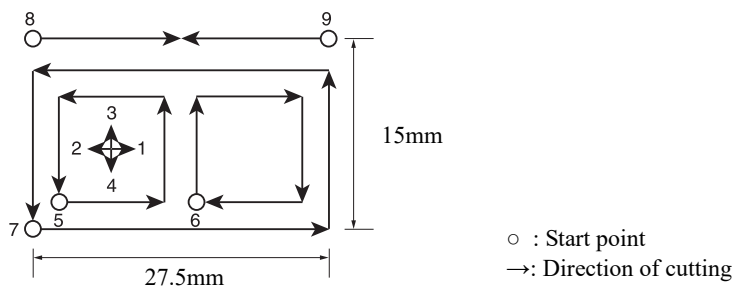

1. **Select a tool to be used for test cut using the [TOOL SELECT] function.**
Call up the first page of the LOCAL menu to the screen. (☞ P. 2-18)

2. **Invoke the LOCAL menu on the screen.**

If the device is in the REMOTE mode, press the key to select the LOCAL mode.

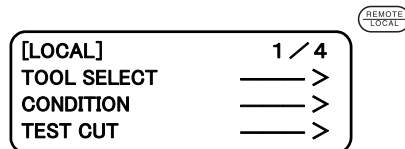

3. **Move the head to a position where test cut is to be performed.**

Press the jog keys to move the head.

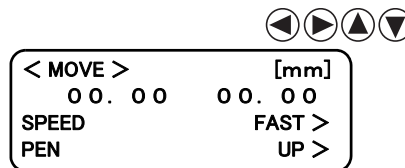

4. **Exit from the MOVE mode.**

Press the key or key to exit from the MOVE mode.

The LOCAL MENU will appear on the screen. If the 1st page of the LOCAL MENU does not appear, press the key to invoke the 1st page on the screen.

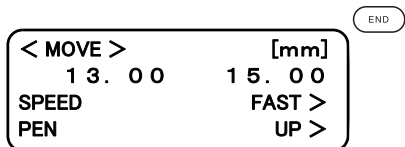

5. **Select the [TEST CUT].**

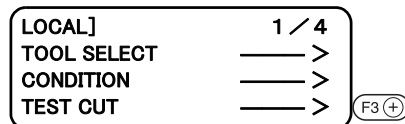

6. Execute the [TEST CUT].

Press the **END** key, and the test cut will be executed.

To cancel the [TEST CUT] press the **CE** key. This restores the step of procedure 2 on the screen.

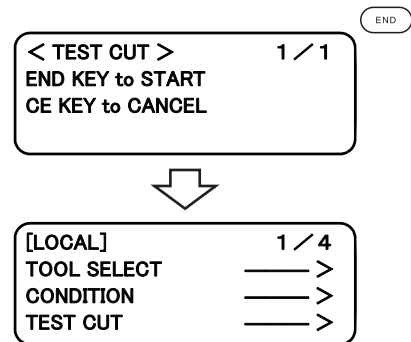

Checking the status of tools

Execute the [TEST CUT] function with the tools specified using the tool selecting function. Items to be checked for the tools are shown in the tables below.

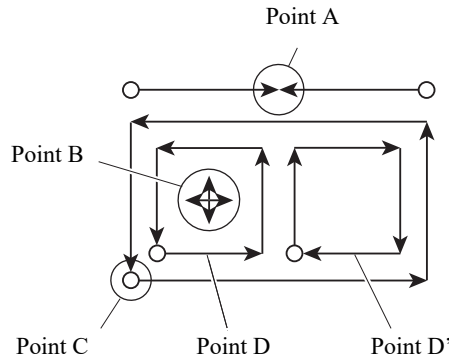



Pen





Checkpoint	Cause	Corrective measure	Reference page
Lines fail to meet at point A.	Pen not securely installed.	Securely tighten the screw in the holder.	P. 2-13
Dots or thin spots are made.	Ink has run out.	Replace the pen with a new one.	P. 2-13
	The pressure is insufficient.	Increase the pressure.	P. 2-21
	The speed is so high that the pen rises above the work.	Decrease the speed.	P. 2-21

Tangential cutter





Check point	Cause	Corrective measure	Reference page
Lines fail to meet at point A.	Set value for the [END CORRECTION] is too small.	Set a larger value for the [END CORRECTION].	P. 2-21
	The cutter is off-center.	Conduct the “adjustment of the eccentricity” that is one of the tool adjusting functions.	P. 3-6
Line at point A is out of position	The tangential cutter is defective in terms of θ angle.	Carry out the “adjustment of the θ angle” that is one of the tool adjusting functions. A part of the work remains uncut.	P. 3-9
The work remains uncut.	The pressure is insufficient.	Increase the pressure.	P. 2-21
A corner of the work remains uncut.	Set value for the [START CORRECTION] and that for the [END CORRECTION] are too small.	Set a larger value respectively for the [START CORRECTION] and the [END CORRECTION].	P. 2-21
D and D' are different in size.	The cutter is off-center.	Conduct the “adjustment of the eccentricity” that is one of the tool adjusting functions.	P. 3-7

Check point	Cause	Corrective measure	Reference page
Cutting depth at C is excessive.	The set value for the [START CORRECTION] is too large.	Set a smaller value for the [START CORRECTION].	 P. 2-21
	The cutter is off-center.	Conduct the “adjustment of the eccentricity” that is one of the tool adjusting functions.	 P. 3-7

Crease roller

Check point	Cause	Corrective measure	Reference page
Lines fail to meet at point A.	The cutter is off-center.	Conduct the “adjustment of the eccentricity” that is one of the tool adjusting functions.	 P. 3-7
Line at point A is out of position.	The tangential cutter is defective in terms of θ angle.	Carry out the “adjustment of the θ angle” that is one of the tool adjusting functions. A part of the work remains uncut.	 P. 3-9
Marking performance is poor.	The pressure is insufficient.	Increase the pressure.	 P. 2-21
	A roller for corrugated fiberboard is used for coated board.	Use a roller for coated board.	—
Corrugated fiberboard is cut out at flutes though marking is performed.	Set value for the [PRESS (Y)] in [CUTTING CONDITIONS] specified using the cutting condition setting functions is too large.	Place the corrugated fiberboard so that its flutes are oriented in Y-axis. Specify a smaller value for the [PRESS (Y)] in the [CUTTING CONDITIONS] using the cutting condition setting functions.	 P. 3-4  P. 2-21

Swivel blade

Check point	Cause	Corrective measure	Reference page
Dots are drawn.	The eccentric cutter is improperly installed.	Securely tighten the screw in the holder.	 P. 2-13
	The speed is too low.	Increase the speed.	 P. 2-21
	The pressure is insufficient.	Increase the pressure.	 P. 2-21
Corners are cut round.	The projecting amount of the blade tip is insufficient.	Increase the projecting amount of the blade tip.	 P. 2-10
	The offset value is too small.	Increase the offset value.	 P. 2-21

Checking the status of tools

Check the relation between the tools (th pen and the tangential cutter, and the pen and the crease roller) using the TEST CUT function.

For this purpose, perform plotting first using the pen, then execute the test cut function using the tangential cutter or the crease roller at the same position to check the relation between the tools.

The following describes how to correct problems on ten samples. The number of items required to be adjusted differs with the samples. Determine the items to be adjusted using the samples as a guide. In these sample, the relation between the pen and the tangential cutter is explained. In the case of the crease roller, read the following while replacing the description “tangential cutter” with the “crease roller.”

Sample A

The tangential cutter is out of the correct position regardless of the proceeding direction.

Corrective measure

Perform the offset function contained in the cutter adjusting functions of the tool adjusting functions. (P. 3-13)

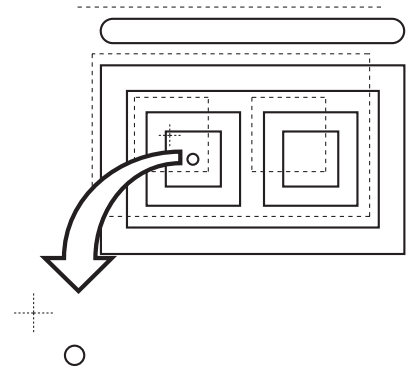

Sample B

The cutter rotates clockwise (or counterclockwise).

Corrective measure

Conduct the q angle adjustment contained in the cutter adjusting functions of the tool adjusting functions. (P. 3-9)

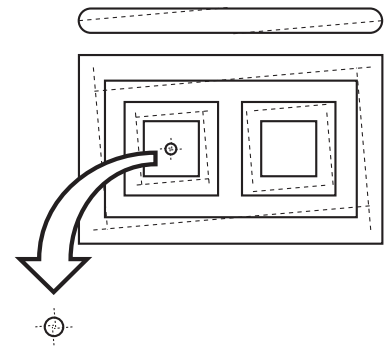

Sample C

The point from which the cutter starts is this side (or far side) of the predetermined start position.

Corrective measure

Adjust the set value for the [START CORRECTION] in [CUTTING CONDITIONS] using the cutting condition setting functions. (☞ P. 2-19)

Adjust the pattern A for the “adjustment of the eccentricity” using the tool adjusting functions. (☞ P. 3-7)

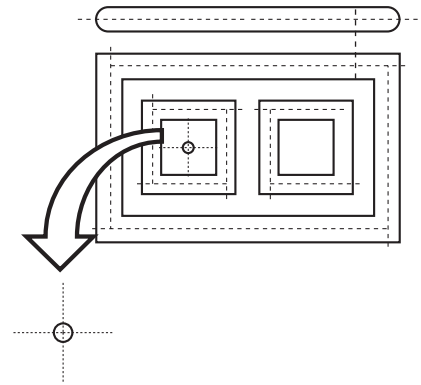

Sample D

The point at which the cutter finishes cutting goes beyond (or does not reach) the predetermined end position.

Corrective measure

Adjust the set value for the [END CORRECTION] in [CUTTING CONDITIONS] using the cutting condition setting functions. (☞ P. 2-19)

Adjust the pattern A for the “adjustment of the eccentricity” using the tool adjusting functions. (☞ P. 3-7)

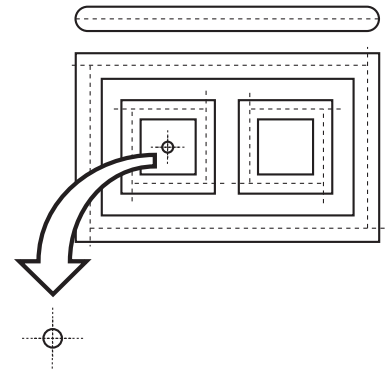

Sample E

The tangential cutter shifts to the right from the correct position in terms of the advancing direction.

Corrective measure

Adjust the pattern A for the “adjustment of the eccentricity” using the tool adjusting functions. (☞ P. 3-7)

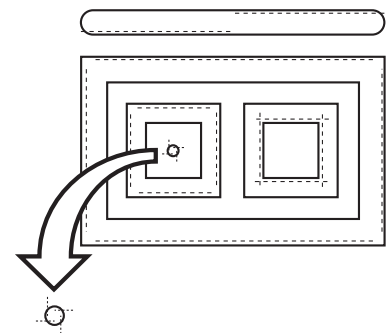

Sample F

The cutter rotates clockwise (or counterclockwise) and the point from which the cutter starts is this side (or far side) of the predetermined start position.

Corrective measure

Refer to the corrective measures for the samples B and C.

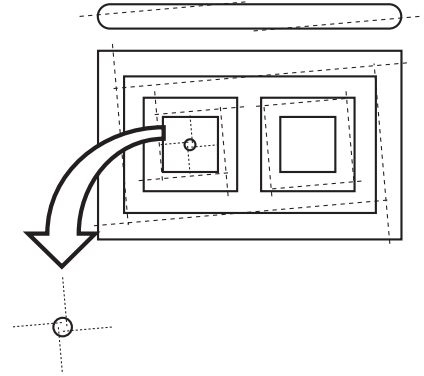

Sample G

The pattern is finished with rotated clockwise (or counterclockwise) and the tangential cutter shifts to the right (or left) from the correct position.

Corrective measure

Refer to the corrective measures for the samples B and E.

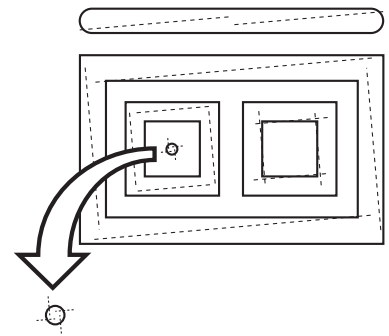

Sample H

The point from which the cutter starts is this side (or far side) of the predetermined start position, and the tangential cutter shifts to the right (or left) from the correct position.

Corrective measure

Refer to the corrective measures for the samples C and E.

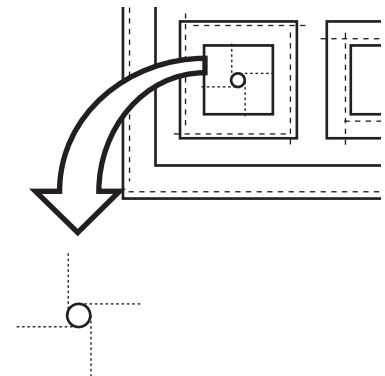

Sample I

The point at which the cutter finishes cutting goes beyond (or does not reach) the predetermined end position, and the tangential cutter shifts to the right (or left) from the correct position.

Corrective measure

Refer to the corrective measures for the samples D and E.

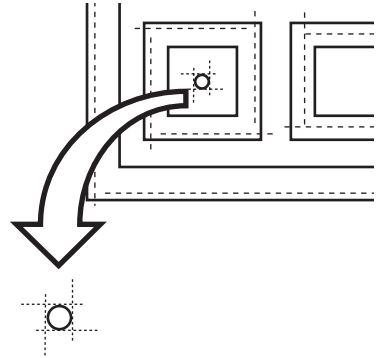
**Sample J**

The cutter rotates clockwise (or counterclockwise), the point at which the cutter finishes cutting goes beyond (or does not reach) the predetermined end position, and the tangential cutter shifts to the right (or left) from the correct position.

Corrective measure

Refer to the corrective measures for the samples B, D and E.

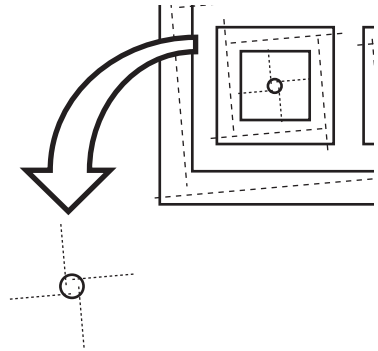

SETTING THE CUTTING AREA [CUT AREA]

The cutting area is maximized when turning on the power to the device. The cutting area can be adjusted to the size of works placed on the device or set to a desired size.

To specify a new cutting area, determine the lower left point (LL; Lower Left) and the upper right point (UR: Upper Right) of the area.

To clear the cutting area specified, re-turn on the power to the device. This will maximize the cutting area.

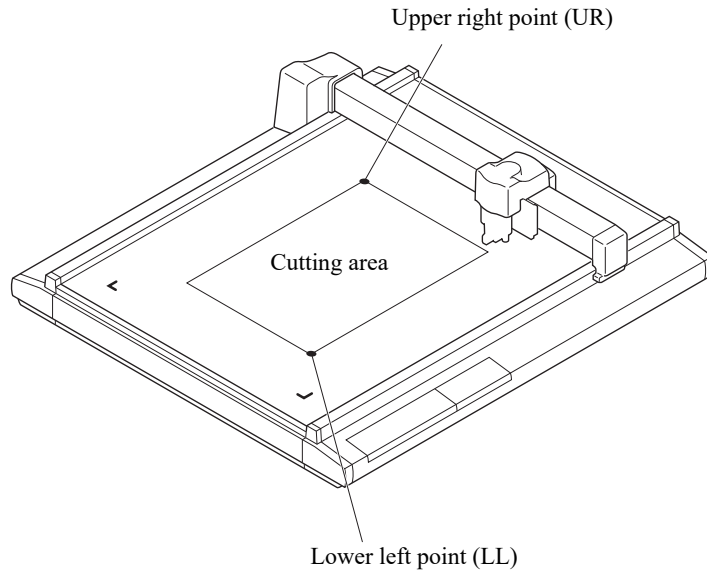

1. Invoke the LOCAL menu on the screen.

If the device is in the REMOTE mode, press the  key to select the LOCAL mode.



2. Press the key several times until the LCD indicates page 4 of the LOCAL MENU.

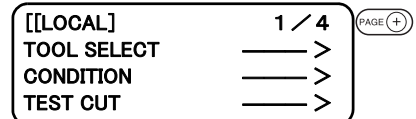

3. Select the [CUT AREA].

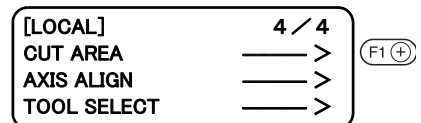

4. Move the tool to the current LL (lower left) point.

The coordinates of the LL point in terms of the command origin are shown on the LCD.

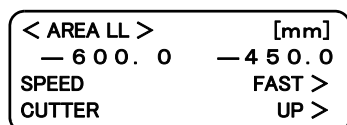
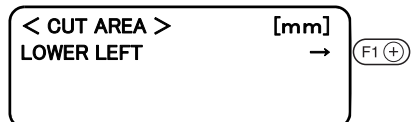

5. Align the tip of the tool to the lower left point of the desired cutting area.

Move the tool using the jog keys until the tip of the tool meets the lower left point (LL) of the cutting area.

Change the head speed or lift/lower the tool when necessary.

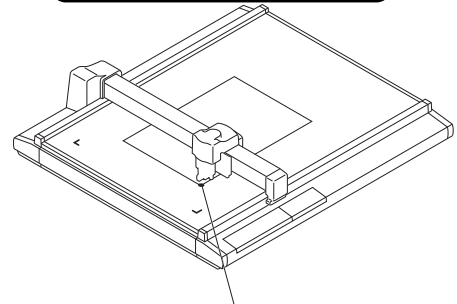
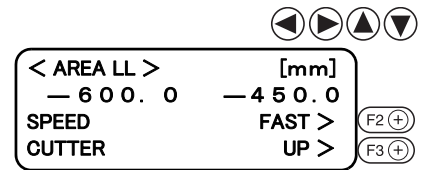

Lower left point (LL)

6. Enter the LL point.

Press the **END** key to enter the input values. If you do not enter the input data, press the **CE** key.

The step of procedure 3 will be restored on the LCD.

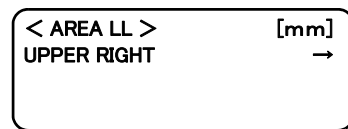
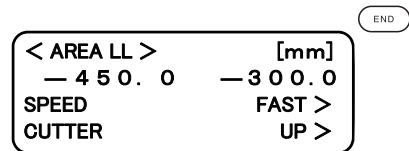

7. Move the tool to the current UR point (upper right).

The coordinates of the UR point in terms of the command origin are shown on the LCD.

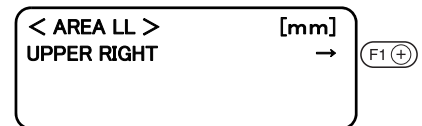

8. Align the tip of the tool to the upper right point of the desired cutting area.

Move the tool using the jog keys until the tip of the tool meets the upper right point (UR) of the cutting area.

Change the head speed or lift/lower the tool when necessary.

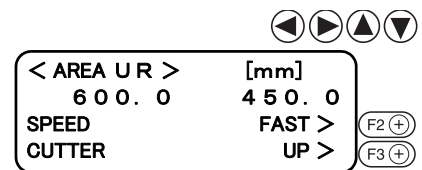

Upper right point (UR)

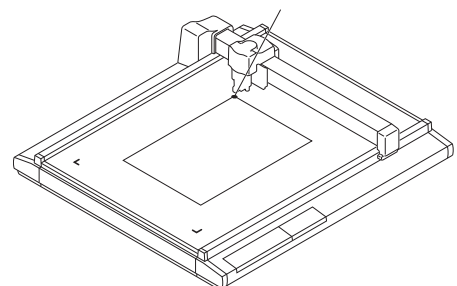

9. Enter the UR point.

Press the **END** key to enter the input values. If you do not enter the input data, press the **CE** key.

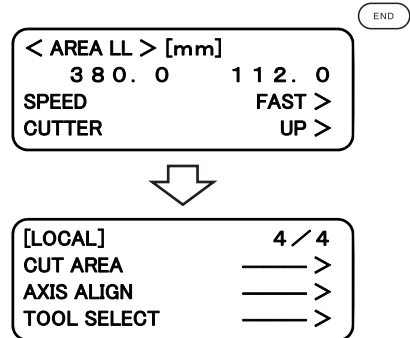

SETTING THE ORIGIN (ORIGIN FOR PLOTTING)

The origin is the reference point that is used for plotting, cutting and creasing.

The plotting position can be moved by changing the location of the origin.

Coordinate of the origin are always (0,0). If the head is moved using the jog keys, the coordinates of the head as from the origin are indicated on the LCD.

Normally, the origin is established at the lower left of the max. effective cutting area.

When executing the sample cut function, each piece of data is cut (crease, plotted) near the origin.

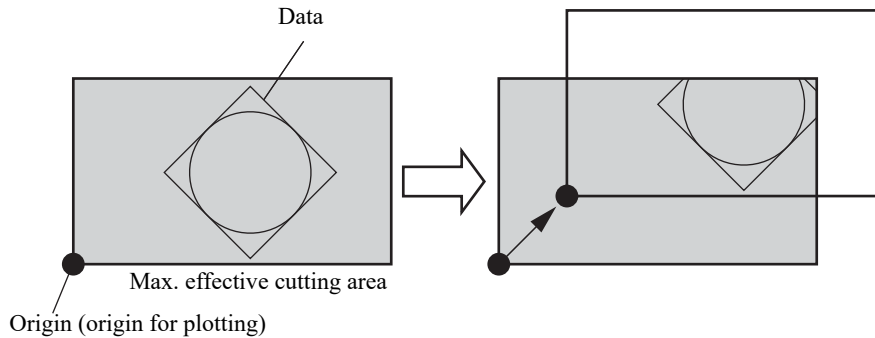

1. Invoke the LOCAL menu on the screen.

If the device is in the REMOTE mode, press the  key to select the LOCAL mode.

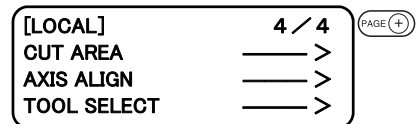

2. Move the head using the jog keys to the point at which the origin is to be set.

Coordinates of the tip of the tool currently selected are shown on the screen.

Increase/decrease the speed and lift/lower the tip of the tool when necessary.

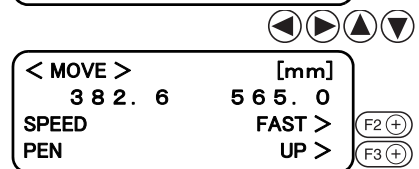

3. Set an origin to the desired point.

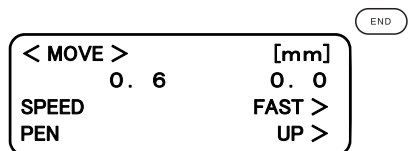

INTERRUPTION OF PROCESSING (PLOTTING, CUTTING OR CREASING)

Under the REMOTE mode, processing can be interrupted due to some reason.

The following explains how to interrupt the process and the function that enables the settings to be changed after the interruption.

How to interrupt/resume the process

1. Press the  LOCAL key while the device is in operation.

After a while, the device stops its performance and enters into the LOCAL mode.



- If the device is processing a circle, it will stop after the completion of the processing of the circle. For other line segments, the device stops after processing them in vectors.





2. Press the  key again.

The device enters the REMOTE mode to resume processing.



Functions that can be specified after the interruption

The device is able to perform the following.

- Cutting conditions can be changed. ( P. 2-19)
- Data remaining in the data receiving buffer can be cleared. ( .P. 2-37)

Interruption of processing [DATA CLEAR]

Received data is cleared from the data receiving buffer.

Date described below can be cleared.

- (1) Processing has been interrupted. But, it is desired to abort the processing.
- (2) It is desired to clear data that has been already received but not yet processed.
- (3) In prior to the receipt of data to be copied using the copy function.

1. If the device is in the REMOTE mode, press the  key to cause the device to enter the LOCAL mode.

If some processing is being done, it will be interrupted.

[LOCAL]	1 / 4	
TOOL SELECT	_____ >	
CONDITION	_____ >	
TEST CUT	_____ >	

2. Press the  key several times until the LCD indicates page 2 of the LOCAL MENU.

[LOCAL]	2 / 4	
DATA CLEAR	_____ >	
COPY	_____ >	
VIEW	_____ >	

3. Select the [DATA CLEAR].

Press the  key.

[LOCAL]	2 / 4	
DATA CLEAR	_____ >	
COPY	_____ >	
VIEW	_____ >	

4. Execute the [DATA CLEAR].

To cancel the [DATA CLEAR], press the  key. The step of procedure 2 will be restored on the screen.

< DATA CLEAR >	1 / 1	
END KEY to START		
CE KEY to CANCEL		
ORGkey to SC.CLR		



[LOCAL]	2 / 4
DATA CLEAR	_____ >
COPY	_____ >
VIEW	_____ >

CHAPTER 3

WHEN ABNORMAL CONDITIONS ARE ENCOUNTERED

This chapter describes how to correct troubles in the event that desired cutting results are not obtained or a failure has occurred.

Table of Contents

<i>IF ANY OF THE BELOW-STATED PHENOMENA TAKES PLACE</i>	3-2
<i>Corrugated board is cut out at flutes though creasing is performed [CONDITION] > [PRESS (Y)].</i>	3-4
<i>TOOLS ARE NOT ALIGNED TO EACH OTHER [TOOL ADJUST]</i>	3-6
<i>IF THERE IS A SIGN OF FAILURE.....</i>	3-17
<i>TROUBLES FOR WHICH ERROR MESSAGES ARE GIVEN ON THE LCD.....</i>	3-19

IF ANY OF THE BELOW-STATED PHENOMENA TAKES PLACE

Cutting depth is insufficient. [CONDITION] > [PRESS CORRECT]

If the cutter is lowered, the work may not be thoroughly cut out though the projecting amount of the blade tip is larger than the thickness of the work.

In this case, the work can be cut out without fail by increasing the pressure applied to the descending cutter. Set a pressure correction value to be added to the previously specified pressure value or set the pressure correction value to a larger value.

Refer to Chapter 2 "Setting cutting conditions" for how to set the pressure correction value. (☞ P. 2-19)

The work remains uncut at the cutting start and end [CONDITION] > [START/END CORRECT]

The position where the cutter comes down or that where it goes up may remain uncut. If the start correction value is increased, the cutter will come down earlier. (☞ P. 2-19)

If the end correction value is increased, the cutter will go up later. (☞ P. 2-21)

[TOOL ADJUST] > [CIRCLE θ -CORRECT]

The end of a cut circle may not meet the start of the circle with respect to thickness and hardness of a work. A close-to-normal circle can be cut by correcting the deviation. Since the deviation varies depending on the size of a circle, this function is used to correct the deviation in terms of circles in five different radius.

- A circle of which radius is " $R < 5$ "
- A circle of which radius is " $5 \leq R < 10$."
- A circle of which radius is " $10 \leq R < 20$."
- A circle of which radius is " $20 \leq R < 50$."
- A circle of which radius is " $50 \leq R < 100$."
- A circle of which radius is " $R \leq 100$ "



- Some CADs cannot conduct this correction.

For a work that is comparatively soft, cut toward inside of a normal circle. For a work that is hard, cut toward outside of a normal circle.

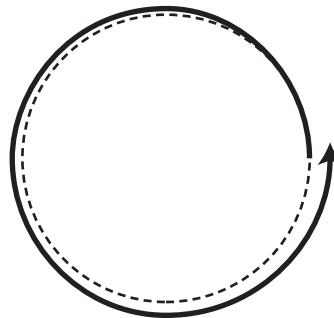
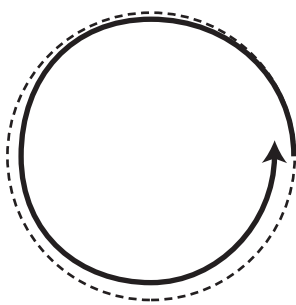

→ ;Direction of cutting
----- ;Locus

IF ANY OF THE BELOW-STATED PHENOMENA TAKES PLACE

How to adjust:

Conduct the adjustment as given in the table below:

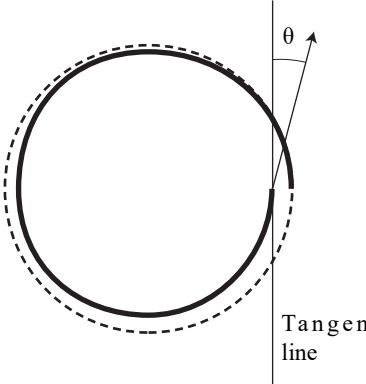
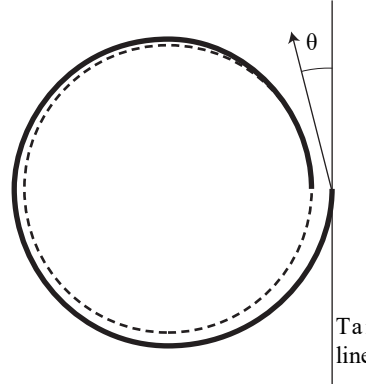
Pattern		
How to adjust	Set a correction angle to the positive side.	Set a correction angle to the negative side.

Corrugated board is cut out at flutes though creasing is performed [CONDITION] > [PRESS (Y)]

When marking corrugated board along with flutes of the corrugated board, the pressure specified in [CUTTING CONDITIONS] can be so high as to break the board.

How to adjust:

Follow the adjusting procedure described below.

Place the corrugated board in such a way that its flutes are in parallel to the Y-axis of this device.

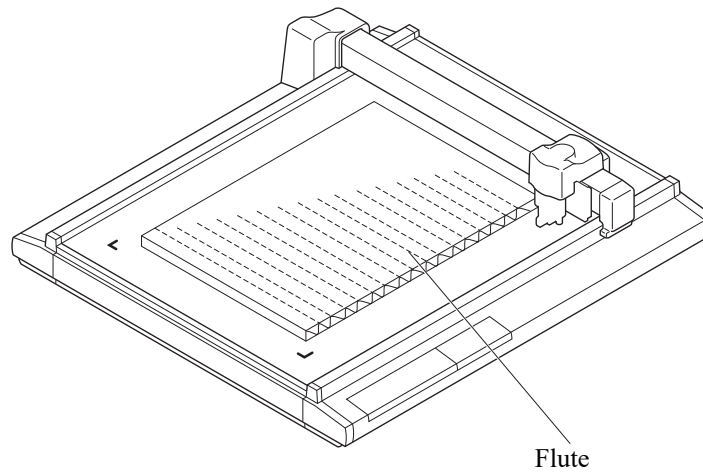

To set a marking pressure in terms of the Y-axis direction, specify how far the pressure is reduced from the pressure value designated in the [CUTTING CONDITIONS]. (☞ P. 2-19)

Square Mark not detected [TOOL Adjust] > [LIGHT POINTER]

If a plotter fails to detect any registration mark properly, the possible cause is an error in the positional relationship between the mark sensor and the light pointer, or error in the setting of square mark detect. In this case, adjust the position of the light pointer.

1. Install a water-based ball-point pen(BK-70) in the ball-point pen holder.

( P. 2-13)

2. Display [Local] menu page 4.

Press the  key several times.

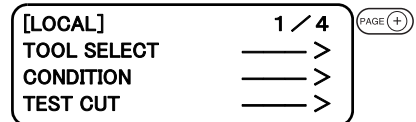

3. Select [TOOL ADJUST]

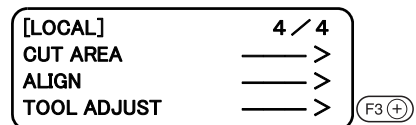

4. Display [TOOL ADJUST] menu page 2.

Press the  key one time.

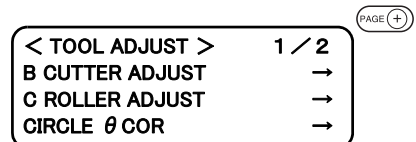

5. Select [LIGHT POINTER]

Change to the menu for adjusting the light pointer position.

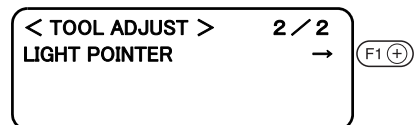

6. Select [TEST PATTERN]

Line length of 10mm cross-shape pattern is plotted.

Light pointer turns on, and move to the center of pattern.

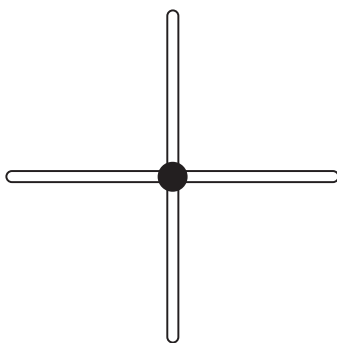

● Light pointer
○ Pen

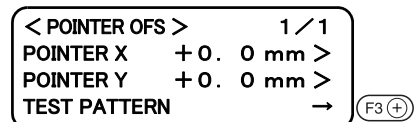

7. Press   key or Jog key, and the light pointer move to the center of pattern.

- 99.9mm to + 99.9mm (0.1mm pitch)

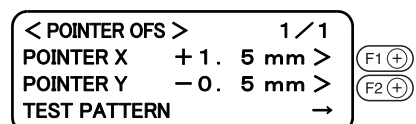

8. Press  key to register the adjusted value.

In case of not register the value, press  key.

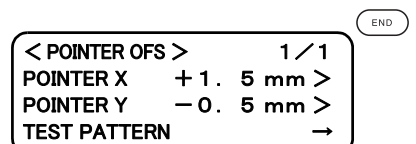

TOOLS ARE NOT ALIGNED TO EACH OTHER [TOOL ADJUST]

If a plotting tool and a cutter or a plotting tool and a marking roller fail to finish patterns that lack in overlapping, the deviation between the tools has to be adjusted. This adjustment targets the tool that is selected by "Tool select" function.

To execute the tool adjusting function, set the speed and acceleration of each tool as described below. If the speed and acceleration are too high, adjustments cannot be carried out with accuracy.

Speed 20 cm/s

Acceleration 0.1 G

Flowchart of checking and adjusting procedures

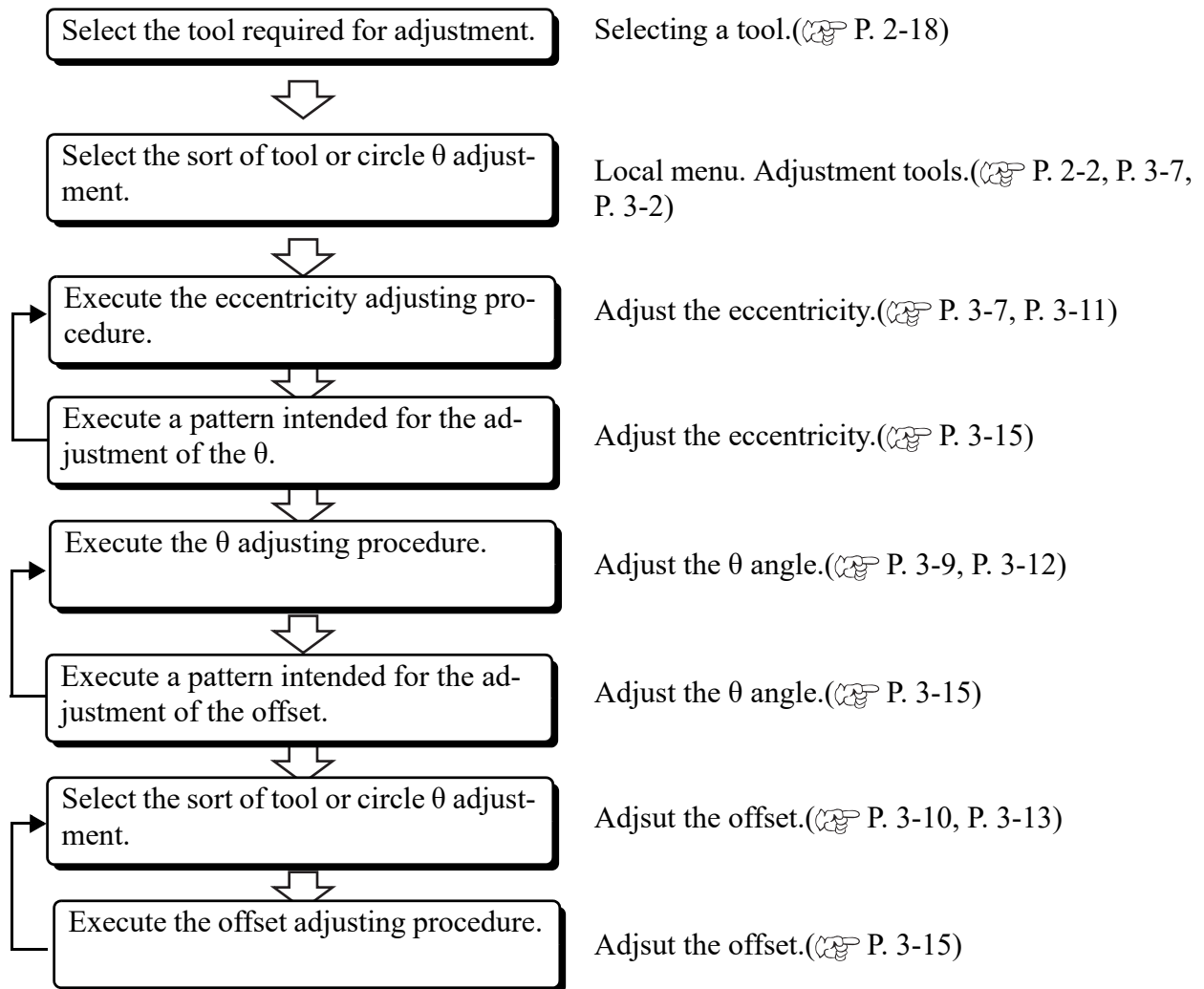

Concerning how to adjust,

General explanation of the adjustment of tools

Tools are adjusted with respect to the below-stated three items.

- (1) "Adjustment of the cutter" to adjust the low-pressure tangential cutter.
- (2) "Adjustment of the roller" to adjust the rollers and "adjustment of the cutter" for the highpressure tangential cutter
- (3) "Adjustment of the circle θ " to adjust the tangential cutter to a plotted circle 1

Adjustment of the cutter

The cutter is adjusted in three different ways as described below.

- (1) "Adjustment of the eccentricity" to adjust the eccentricity of the blade tip and tools
- (2) "Adjustment of θ angle" to adjust the rotating angle of the cutter
- (3) "Adjustment of the offset" to eliminate the deviation between the tangential cutter and the pen

Adjustment of the eccentricity

The blade tip or a tool may be off-center when it is replaced. The following indicates an example of the blade tip or tool that is off-center and how to adjust it.

Two different patterns for adjustment are simultaneously cut. Sizes of the patterns and the cutting order are shown below.

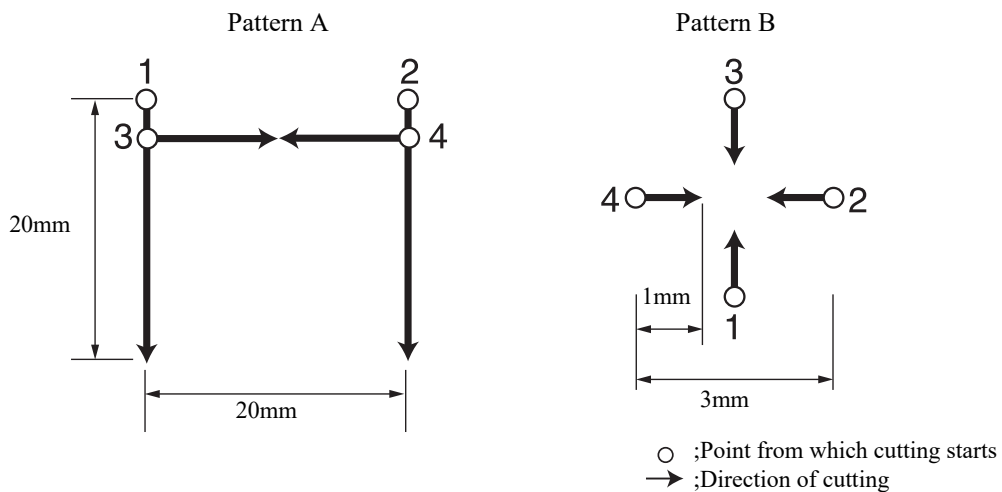

How to adjust:

Follow the adjusting procedure given below.

Pattern A has to be adjusted to correct the problem where the blade tip is out of the center of the cutter holder.

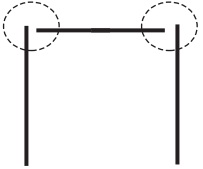
		Pattern A	
Sample pattern			
How to adjust	Input a negative value as "A" that corresponds to the length of the line which goes beyond the vertical line.	Input a positive value as "A" that corresponds to the length to be plotted to reach the vertical line.	

In pattern B, the tool is installed with tilted. Pattern B has to be adjusted so that horizontal lines and vertical lines are arranged in a straight line respectively along X- and Y-axes.

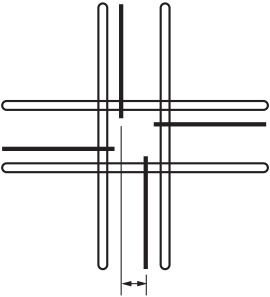
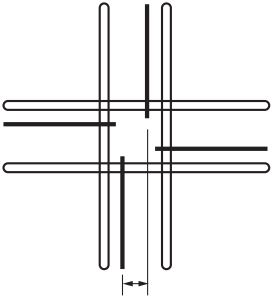
		Pattern B	
Sample pattern			
How to adjust	Input a positive value as "B" that corresponds to a half of the distance between the two lines.	Input a negative value as "B" that corresponds to a half of the distance between the two lines.	

Adjustment of the θ angle

The rotating angle of the tangential cutter is adjusted.

Eliminate the difference in rotating angle between the plotted pattern and the cut pattern.

Two different patterns are used for adjustment. They are different only in size.

The illustration below indicates the size of the patterns and the cutting order. Dimensions shown in parentheses are the dimensions of pattern No. 2.

Pattern 1 (Pattern 2)

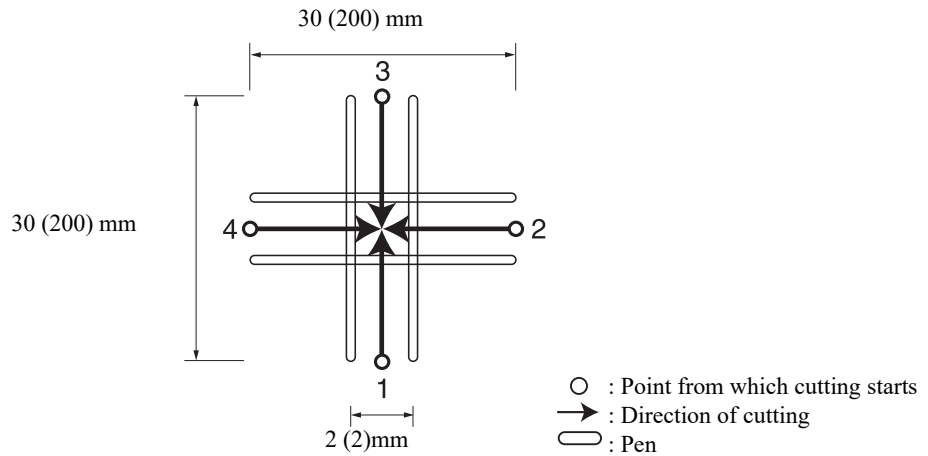

How to adjust:

Follow the adjusting procedure given below.

		Pattern 1 (Pattern 2)	
Sample pattern			
How to adjust	If the cut pattern rotates clockwise as compared with the plotted pattern, decrease the θ value for the cutter.	If the cut pattern rotates clockwise as compared with the plotted pattern, increase the θ value for the cutter.	

Adjustment of the offset

Offset amount of the cut pattern as from the plotted pattern is adjusted in terms of the X- and Y-axes. One pattern is used for adjustment. The illustration below indicates the size of the patterns and the cutting order.

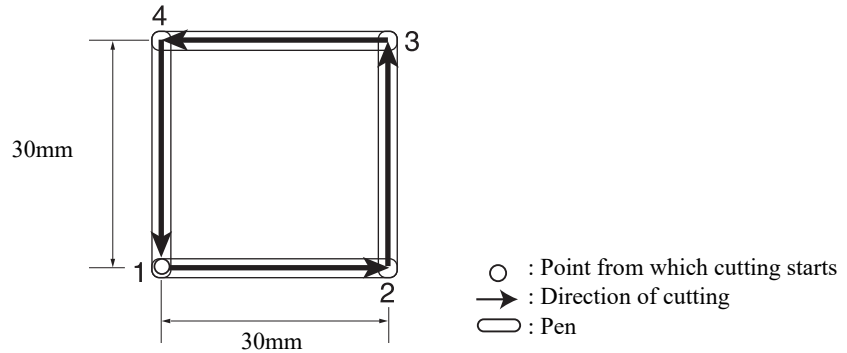

How to adjust:

Follow the adjusting procedure given below.

Sample pattern		
How to adjust	If the cutter deviates to the right, increase the X value for the cutter.	If the cutter deviates to the left, decrease the X value for the cutter.

Sample pattern		
How to adjust	If the cutter deviates upward, increase the Y value for the cutter.	If the cutter deviates downward, decrease the Y value for the cutter.

Adjustment of the roller

The roller is adjusted in three different ways as described below.

- (1) "Adjustment of the eccentricity" to adjust the eccentricity of the tools
- (2) "Adjustment of the θ angle" to adjust the rotating angle of the roller
- (3) "Adjustment of the offset" to eliminate the deviation between the roller and the pen

Adjustment of the eccentricity

The tool may be off-center when it is replaced. The following indicates an example of the tool that is off-center and how to adjust it.

Two different patterns are used for adjustment. Pattern A is used for the adjustment of marking.

Pattern B is used for the adjustment of plotting and marking. Sizes of the patterns and the cutting order are shown below.

For pattern A, the marking roller, being different from the tangential cutter, goes beyond the cutting area even it is not off-center.

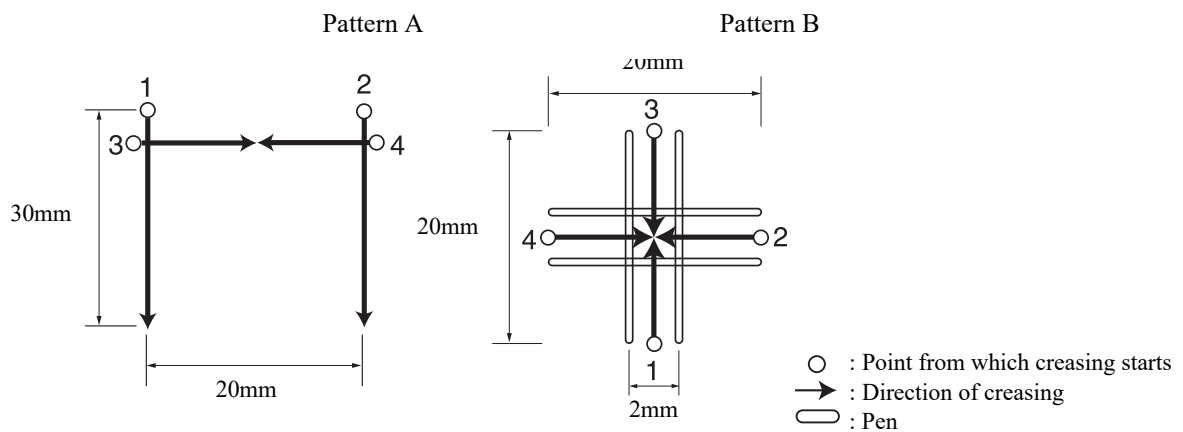

How to adjust:

Pattern A has to be adjusted to correct the problem where the blade tip is out of the center of the roller holder.

	Pattern A	
Sample pattern		
How to adjust	Input a negative value as "A" that corresponds to the length of the line which goes beyond the vertical line.	Input a positive value as "A" that corresponds to the length to be plotted to reach the vertical line.

In pattern B, the tool is installed with tilted. Pattern B has to be adjusted so that horizontal lines and vertical lines are arranged in a straight line respectively along X- and Y-axes.

		Pattern B	
Sample pattern			
How to adjust	Input a positive value as "B" that corresponds to a half of the distance between the two lines.	Input a negative value as "B" that corresponds to a half of the distance between the two lines.	

Adjustment of the θ angle

The rotating angle of the roller is adjusted.

Eliminate the difference in rotating angle between the plotted pattern and the marked pattern.

One pattern is used for adjustment.

The illustration below gives the size of the pattern and the cutting order.

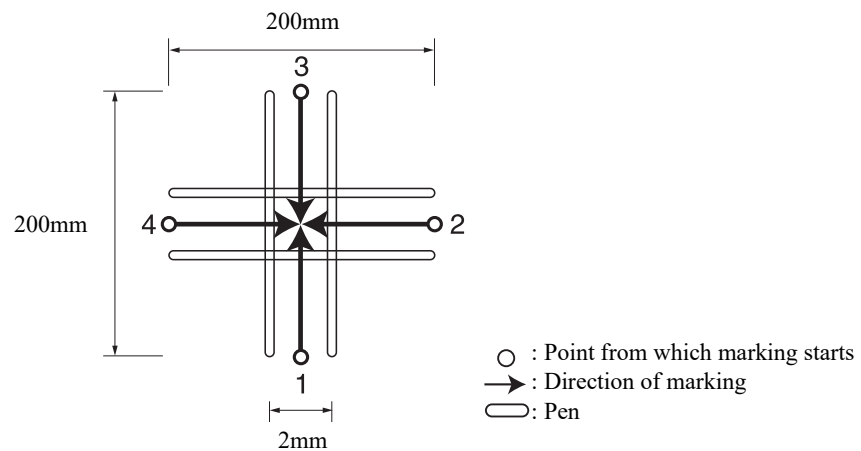

How to adjust:

Follow the adjusting procedure given below.

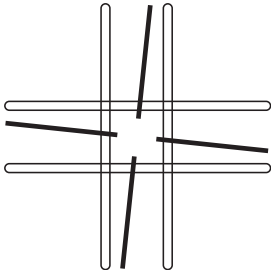
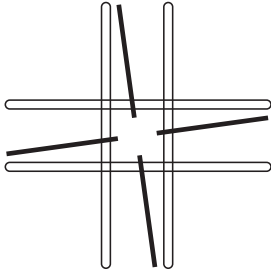
Sample pattern		
How to adjust	If the cut pattern rotates clockwise as compared with the plotted pattern, decrease the θ value for the roller.	If the cut pattern rotates counter clockwise as compared with the plotted pattern, increase the θ value for the roller.

Adjustment of the offset

Offset amount of the marked pattern as from the plotted pattern is adjusted in terms of the X- and Y-axes. One pattern is used for adjustment.

The illustration below indicates the size of the pattern and the cutting order.

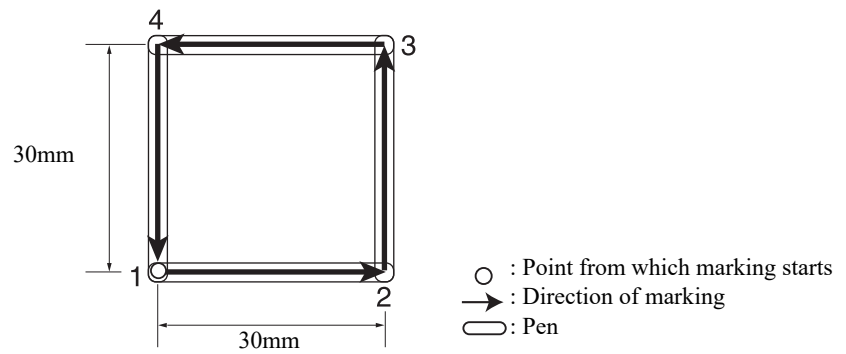

How to adjust:

Follow the adjusting procedure given below.

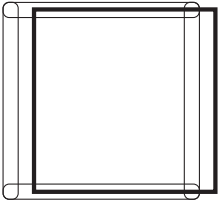
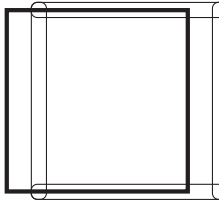
Sample pattern		
How to adjust	If the roller deviates to the right, increase the X value for the roller.	If the roller deviates to the left, decrease the X value for the roller.

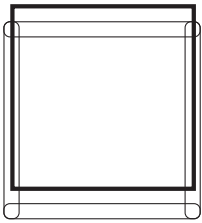
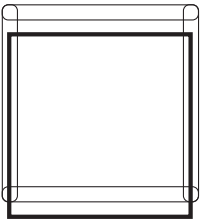
Sample pattern		
How to adjust	If the roller deviates upward, increase the Y value for the roller.	If the roller deviates downward, decrease the Y value for the roller.

How to adjust the tools

“TOOL SELECT” consists of two categories; i.e., the “adjustment of the cutter”, the “adjustment of the roller” and "circle θ adjust".

The tool adjusting procedure is described below taking the “adjustment of the cutter 1” as an example.

1. **Attach a pen and a tangential cutter to the head.** (☞ P. 2-13, P. 2-14)

2. **The tool of the cutter 1 is chosen.** (☞ P. 2-18)

< CUTTER 1 >	1 / 4	
SPEED	*40 cm/s >	
PRESSUR	*400 g >	F2 (+)
ACCELE	*0.4 G >	

3. **Press the $\text{PAGE} (+)$ key several times until the LCD indicates page 4 of the LOCAL MENU.**

[LOCAL]	1 / 4	PAGE (+)
TOOL SELECT	_____ >	
CONDITION	_____ >	
TEST CUT	_____ >	

4. **Select the [TOOL ADJSUT].**

[LOCAL]	4 / 4	
CUT AREA	_____ >	
ALIGN	_____ >	
TOOL ADJUST	_____ >	F3 (+)

5. **Select the [CUTTER ADJUST].**

< TOOL ADJUST >	1 / 1	
B CUTTER ADJUST	_____ >	F1 (+)
C ROLLER ADJUST	_____ >	
CIRCLE q CORP	_____ >	

6. **To check for the eccentricity of the cutter, select the [TEST PATTERN] to cut patterns A and B.**

Normal pattern A

Normal pattern B

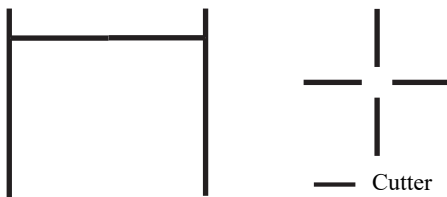

< ADJ > SWIVEL	1 / 3	
A (LNG)	** . ** >	
B	** . ** >	
TEST PATTERN	_____ >	F3 (+)

7. **Input a value for each pattern.**

For [A], input an adjustment value for pattern A.

For [B], input an adjustment value for pattern B.

< ADJ > SWIVEL	1 / 3	F1 (+)
A (LNG)	** . ** >	F2 (+)
B	** . ** >	
TEST PATTERN	_____ >	

8. **Carry out steps of procedure 6 and 7 in repetition.**

Repeat these steps of procedure until a normal pattern is obtained.

9. **Invoke the 2nd page of the ADJUSTMENT menu.**

Press the $\text{PAGE} (+)$ key several times to call up the menu for the adjustment of the q angle.

< ADJ > SWIVEL	1 / 3	PAGE (+)
A (LNG)	** . ** >	
B	** . ** >	
TEST PATTERN	_____ >	

10. **Select the pattern for the adjustment.**

1, 2

< ADJUST > θ	2 / 3	
CUTTER θ	** . ** >	
PATTERN No.	* 1 >	F2 (+)
TEST PATTERN	_____ >	

11. To check the q angle, select the [TEST PATTERN].

Plot the pattern using the pen, then cut the pattern with the tangential cutter.

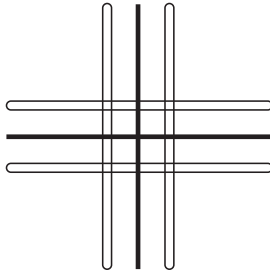

○ Pen
— Cutter

```
< ADJUST >  θ      2 / 3
CUTTER θ      * * . * * >
PATTERN No.   * 1 >
TEST PATTERN  _____ >
```

F3 (+)

12. Input a value for the [CUTTER θ].

Increasing a value will rotate the pattern clockwise.

Decreasing a value will rotate the pattern counterclockwise.

```
< ADJUST >  θ      2 / 3
CUTTER θ      * * . * * >
PATTERN No.   * 1 >
TEST PATTERN  _____ >
```

F1 (+)

13. Carry out steps of procedure 11 and 12 in repetition.

Repeat these steps of procedure until a normal pattern is obtained.

14. Invoke the 3rd page of the ADJUSTMENT menu.

Press the **PAGE (+)** key several times to invoke the menu for the adjustment of the offset.

```
< ADJUST >  θ      2 / 3
CUTTER θ      * * . * * >
PATTERN No.   * 1 >
TEST PATTERN  _____ >
```

PAGE (+)

15. To check the amount of deviation, select the [TEST PATTERN].

Plot the pattern using the pen, then cut the pattern with the tangential cutter.

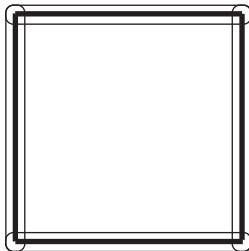

○ Pen
— Cutter

```
< ADJ > OFFSET      3 / 3
CUTTER X            * * . * * >
CUTTER Y            * * . * * >
TEST PATTERN        _____ >
```

F3 (+)

16. Input a value for each item.

Input the amount of deviation in the X-axis for the [CUTTER X].

Input the amount of deviation in the Y-axis for the [CUTTER Y].

```
< ADJ > OFFSET      3 / 3
CUTTER X            * * . * * >
CUTTER Y            * * . * * >
TEST PATTERN        _____ >
```

F1 (+)

F2 (+)

17. Carry out steps of procedure 15 and 16 in repetition.

Repeat these steps of procedure until a normal pattern is obtained.

18. Enter the adjustment value.

If the adjustment value is not entered, press the **CE** key.



```
< ADJ > OFFSET      3 / 3
CUTTER X            * * . * * >
CUTTER Y            * * . * * >
TEST PATTERN        _____ >
```

END



TROUBLESHOOTING

Corrective measures against troubles in the case where no error message is given on the LCD are described in this section. Refer to the description given in “Troubles for which error messages are given on the LCD” in Chapter 3 for a trouble that is not covered in this section and accompanied by the indication of an error message on the LCD. (P. 3-19)



The device not at all actuates even when the power to the device is turned on

Cause	Corrective measure	Reference page
Is the power cable securely connected to the device?	Properly connect the power cable to the device.	 P. 1-13
Properly connect the power cable to the device.	Release the EMERGENCY switch from the pressed state.	 P. 1-16



The device fails to actuate even when data is transmitted from CAD

Cause	Corrective measure	Reference page
Is the device set in the LOCAL mode?	Set the device to the REMOTE mode.	 P. 1-17
Is the interface cable securely connected to the device?	Properly connect the interface cable to the device.	 P. 1-13





Error arises when transmitting data

Cause	Corrective measure	Reference page
Do communication conditions match those on the computer?	Adjust the communication conditions to those on the computer.	 P. 1-19
Do commands on the computer match those on the plotter?	Adjust the commands on the plotter to those on the computer.	 P. 1-25

The tool drags on the sheet of paper

Cause	Corrective measure	Reference page
Is there any wrinkle or warpage on the sheet of paper?	Smooth down the sheet of paper to remove wrinkles and warpings.	 P. 2-8
Is the height of the head excessively low?	Properly adjust the height of the head to the thickness of the work used.	 P. 2-16
Is the lifting/lowering movement of the pen defective?	Turn the power off. Then, move the head A up and down. If the head fails to go up and come down normally, please contact your local dealer or MIMAKI office.	—

Dotted lines or blurred lines are plotted

Cause	Corrective measure	Reference page
Has the screw in head A loosened?	Firmly re-tighten the screw in the head A.	 P. 2-13
Is the plotting speed too high?	Decrease the plotting speed.	 P. 2-21
Is the plotting pressure insufficient?	Increase the plotting pressure.	 P. 2-21
Has the pen run out of ink?	Replace the pen with a new one.	 P. 2-13

TROUBLES FOR WHICH ERROR MESSAGES ARE GIVEN ON THE LCD

If something is wrong with the device, a corresponding error message is given on the LCD. Causes of and corrective measures against such errors are described below.

Errors that can be corrected by users

The table below gives the errors that can be corrected by users.

Error message	Cause	Corrective measure
ERROR 10 COMMAND ERROR 11 PARAMETER ERROR 12 DEVICE	Communication conditions on the device are different from those on the computer.	Adjust the communication conditions on the device to those on the computer. (☞ P. 1-19)
ERROR 13 POLYGON	Polygon buffer has overflowed.	Divide first the polygon data, then transmit the divided polygon data.
ERROR 20 I/O	Communication conditions on the device are different from those on the computer.	Adjust the communication conditions on the device to those on the computer. (☞ P. 1-19)
	Power to the computer and that to the device are turned on in the wrong order.	Turn on the power to the computer first, then turn on the power to the device.
ERROR 27 BUFFER OVER	An abnormal condition has arisen in the serial interface.	Adjust the communication conditions on the device to those on the computer. (☞ P. 1-19)
ERROR 30 OPERATION	Improper key operation is carried out such as a change in the communication conditions while cutting or other performance of the device is interrupted.	Do not conduct any improper key operation.
	The effective area is smaller than A3 and ASCII damp is executed.	Set the effective area to A3 size (297 x 420 mm) or more. Then, execute ASCII damp.
	The origin is set to a position where the effective area of A3 size is not ensured, and ASCII damp is executed.	
ERROR 31 NO DATA	Copy function is executed in the case where no data is received.	Transmit data to be copied from the computer to the device. Then cut a pattern according to the data. Then, execute the copy function. (☞ P. 4-4)
ERROR 32 DATA IS TOO LARGE	Size of data to be copied exceeds 1 MB.	Transmit data of which size is smaller than 1 MB.

ERROR 36 MARK DETECT	NO registration mark was detected.	Check the sheet for curling
		Check to see if the starting point to detect the registration mark has been set properly. (P. 5-15)
		Check to see if the black or white registration mark is printed .
		Check to see if there is no dust or dirt between the registration marks.
		Check to see if there is mistake in registration mark settings. (P. 5-11)
		Confirm the status and the settings described above. If still no registration mark is detected, contact your distributor or a sales office of Mimaki.
ERROR 36 MARK DETECT Stop Data send & Exec.[DATA CLEAR] - PUSH ANY Key -	NO registration mark was detected.	Stop data send and clear the data. (P. 2-37) By pressing any keys, return to the Rocal mode.
ERROR 62 VACUUM	Overcurrent is fed to the blower.	Turn off the power to the plotter and blower. Then, wait for a while and return on the power to them.
ERROR 91 MARK POS	Register mark is placed other than sensor moving range.	Move the media so that the register mark is within the sensor moving range.
***OFF-SCALE ***	Data exceeds the effective cutting area.	(1) Interrupt the process (P. 2-37) and clear the data. (2) Expand the effective cutting area, or place the data inside the effective cutting area.

TROUBLES FOR WHICH ERROR MESSAGES ARE GIVEN ON THE LCD

Errors that cannot be corrected by users

If any of the errors described below has arisen, immediately turn off the power to the device. Wait for a while and re-turn on the power to the device. If the same message appears on the LCD, immediately turn the power off and contact your local dealer or MIMAKI office.

Error message	Error message
ERROR 00 MAIN ROM	ERROR 42 X OVERCURRENT
ERROR 01 SERVO ROM	ERROR 43 Y OVERCURRENT
ERROR 02 MAIN RAM	ERROR 46 PEN SENSOR
ERROR 03 SERVO RAM	ERROR 50 X SENSOR
ERROR 04 EEPROM	ERROR 51 Y SENSOR
ERROR 05 HANDSHAKE	ERROR 52 θ ORIGIN
ERROR 06 BUFFER	ERROR 53 Z ORIGIN
ERROR 08 POWER	ERROR 70 θ OVERLOAD
ERROR 12 DEVICE ERROR 20	ERROR 71 θ OVERCURRENT
ERROR 20 I/O	ERROR 72 CUTTER Z LOAD
ERROR 40 X OVERLOAD	ERROR 73 ROLLER Z LOAD
ERROR 41 Y OVERLOAD	ERROR 90 F/W



CHAPTER 4

APPLICATION FUNCTIONS

This chapter describes helpful functions that facilitate operation.

Table of Contents

<i>ASSIGNMENT OF PEN NUMBERS [MODE SET] > [PEN ASIGN]</i>	<i>4-2</i>
<i>RE-CUT OF THE SAME DATA [COPY]</i>	<i>4-4</i>
<i>SETTING THE NUMBER CUT FUNCTION [MODE SET] > [MULTI-PASS]</i>	<i>4-6</i>
<i>SETTING THE ONE-STROKE CUTTING [MODE SET] > [ONE STROKE]</i>	<i>4-8</i>
<i>SETTING THE DIRECTION OF ROTATION FOR THE COORDINATE AXIS [MODE SET] > [ROTATE]</i>	<i>4-9</i>
<i>SETTING THE CUTTER STROKE [MODE SET] > [Z STROKE]</i>	<i>4-10</i>
<i>SETTING THE UNIT TO BE USED FOR INDICATION [MODE SET] > [UNIT]</i>	<i>4-11</i>
<i>SETTING THE DUMMY CUT OPERATION OF THE SWIEVEL BLADE [MODE SET] > [DUMMY CUT]</i>	<i>4-12</i>
<i>ALIGNMENT OF MECHANICAL AXES TO RULED LINES PRINTED [AXIS ALIGN]</i>	<i>4-13</i>
<i>EXPAND THE CUTTING AREA [EXPANDS]</i>	<i>4-15</i>

ASSIGNMENT OF PEN NUMBERS [MODE SET] > [PEN ASIGN]

Pen numbers included in data are assigned to tools of the device. As many as six pens can be assigned to the tools. Operating procedure is described in this section using the example given below.

Pen 1 (Pen number in data to be plotted) → Pen

Pen 2 (Pen number in data to be cut) → Cutter 22

If the pen numbers are assigned as stated above, data on pen 1 and pen 2 can be plotted and cut at a time.

1. **Invoke the LOCAL menu on the Press the  key several times until the LCD indicates page 3 of the LOCAL MENU.**

[LOCAL]	1 / 4	
TOOL SELECT	_____ >	
CONDITION	_____ >	
TEST CUT	_____ >	

2. **Select the [MODE SET].**

[LOCAL]	3 / 4	
INTERFACE	_____ >	
MODE SET	_____ >	
SELF TEST	_____ >	

3. **Press the  key several times until the LCD indicates page 5 of the [MODE SET].**

< MODE SET >	1 / 6	
Z STROKE	* 7 mm >	
MULTI-PASS	_____ >	
VACUUM	* AutoOFF >	

4. **Select the [PEN ASSIGN].**

< MODE SET >	5 / 6	
PEN ASIGN	_____ >	
RESERVE		
UNIT	* mm >	

5. **Change the head from [B] to [A].**
B, A

< PEN ASIGN >	1 / 6	
PEN 1		
HEAD	* B >	
TOOL *	CUTTER 1 >	

6. **Set the tool to [PEN].**
Pen, Swivel blade

< PEN ASIGN >	1 / 6	
PEN 1		
HEAD	A >	
TOOL	* PEN >	

7. **Invoke the [PEN 2] setting menu.**

< PEN ASIGN >	2 / 6	
PEN 1		
HEAD	A >	
TOOL	* PEN >	

8. **Change the head from [A] to [B].**
A, B

< PEN ASIGN >	2 / 6	
PEN 1		
HEAD	* A >	
TOOL *	CUTTER 1 >	

9. **Press the  key to set the tool to [CUTTER 2].**
Cutter 1, Cutter 2

< PEN ASIGN >	2 / 6	
PEN 1		
HEAD	* B >	
TOOL *	CUTTER 2 >	

10. Enter the input value.

If you do not enter the input data, press the  key.

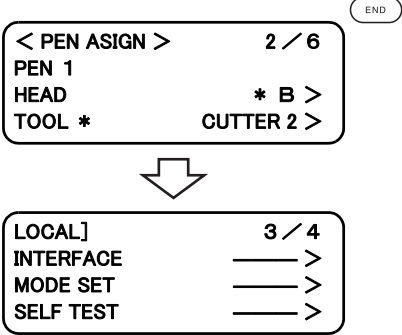

RE-CUT OF THE SAME DATA [COPY]

Data that has been already cut can be re-cut in the off-line state. This means that the same data need not be transmitted from the computer in repetition.



- Be sure to execute the “DATA CLEAR” to clear data from the receiving buffer before transmitting data to be copied. If the “DATA CLEAR” is not executed, pieces of data other than the object data will be copied.

1. Execute the [DATA CLEAR]. (☞ P. 2-37)

Execute the data clear function immediately before receiving the object data to be copied.

2. Cut a pattern according to the object data.

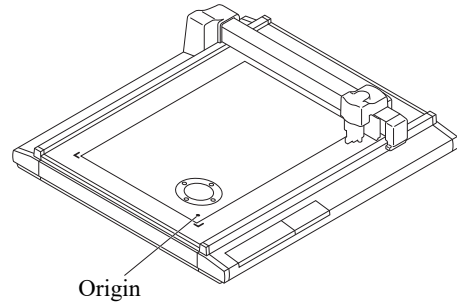

3. Cause the device to enter the LOCAL mode.

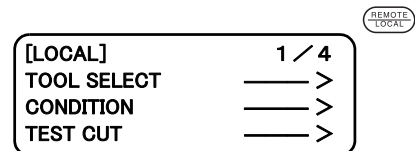

4. Shift the origin using the jog keys. (☞ P. 2-36)

Re-set the origin to a position at which the object data is to be copied. If the origin is re-positioned, the device will perform cutting at the position same as the previous cutting.

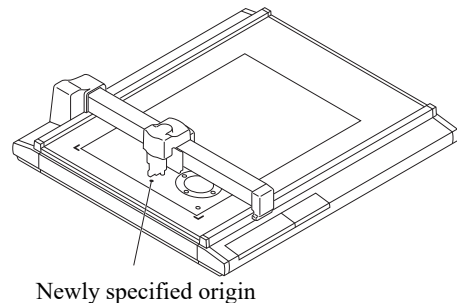

5. Invoke the 2nd page of the LOCAL menu on the screen.

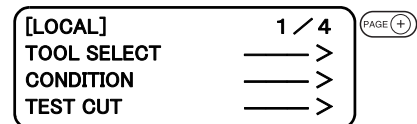

6. Select the [COPY].

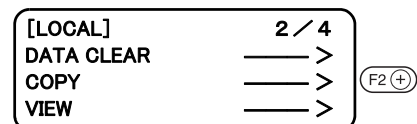

7. Execute the [COPY].

Press the **END** key to execute the copy function.

If you do not want to copy the object data, press the **CE** key.

If you want to perform cutting again, repeat the aforementioned steps of procedure from step 4.

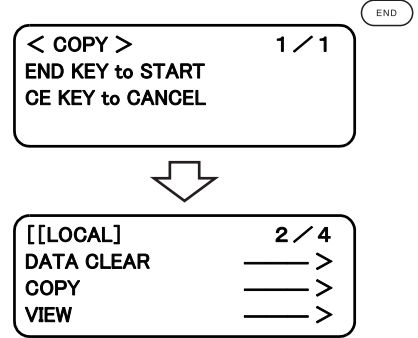
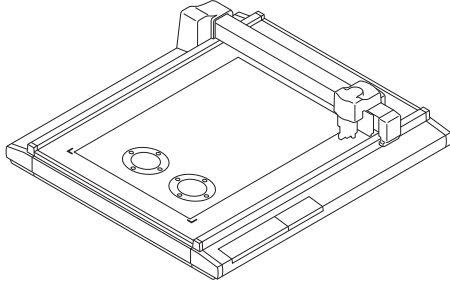

SETTING THE NUMBER CUT FUNCTION [MODE SET] > [MULTI-PASS]

The same data can be cut as many as five times by changing the pressure values. This allows the device to efficiently cut a work that cannot be thoroughly cut out by performing cutting once.

A period of time required to judge a separating point between pieces of data can also be specified.

The device starts the multi-pass unless the device receives next piece of data within the specified period of time.

Set values

Period of time required for judgment: Off, 5, 15, 30, 45, 60 Sec

PRESS 1: Off, 300 to 5000 g (in increments of 50 g)

PRESS 2: Off, 300 to 5000 g (in increments of 50 g)

PRESS 3: Off, 300 to 5000 g (in increments of 50 g)

PRESS 4: Off, 300 to 5000 g (in increments of 50 g)

PRESS 5: Off, 300 to 5000 g (in increments of 50 g)

If the PRESS 1 to PRESS 5 are set to “off,” the device will not perform the multi-pass.

1. Press the  key several times until the LCD indicates page 3 of the LOCAL MENU.

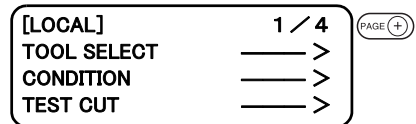

2. Select the [MODE SET].

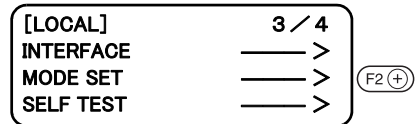

3. Select the [MULTI-PASS].

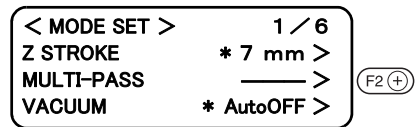

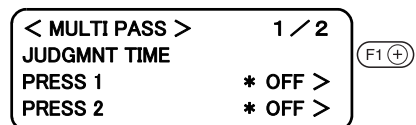

4. Establish the [JUDGMENT TIME].

Off, 5, 15, 30, 45, 60 (s)

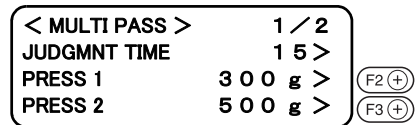

5. Specify cutting pressure values for the first and second cutting operations.



6. Press the  key several times to invoke the 2nd page of the [MULTIPASS].

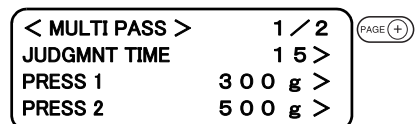

7. Specify cutting pressure values for the third and fourth and fifth cutting operations.

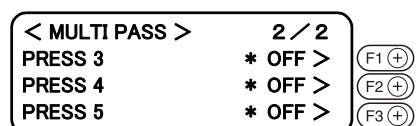

8. Enter the input values.

Press the **END** key to enter the input values. If you do not enter the input data, press the **C.E** key.

< MULTI PASS >	2 / 2
PRESS 3	7 0 0 g >
PRESS 4	9 0 0 g >
PRESS 5	1 0 0 0 g >

END



[LOCAL]	3 / 4
INTERFACE	_____ >
MODE SET	_____ >
SELF TEST	_____ >

SETTING THE ONE-STROKE CUTTING [MODE SET] > [ONE STROKE]

Received data on non-connected line segments illustrated below can be cut in such a manner as a one-stroke brush.

To use the register mark sensor, this function will be rendered ineffective.

Set values

off : Single-stroke cutting is not performed.

on : Single-stroke cutting is executed.

sort : Single-stroke cutting is executed while taking a position that is situated closest to the tool as a start point.

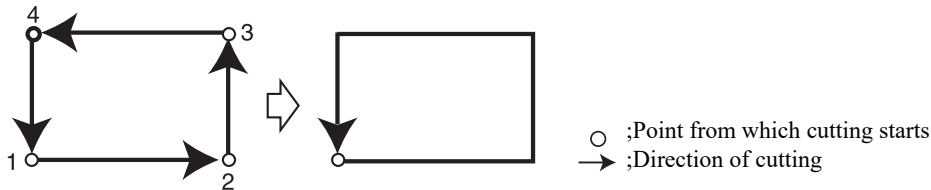

1. Press the **(PAGE +)** key several times until the LCD indicates page 3 of the LOCAL MENU.

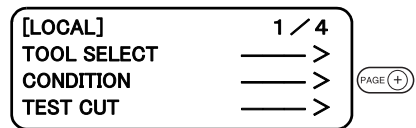

2. Select the [MODE SET].

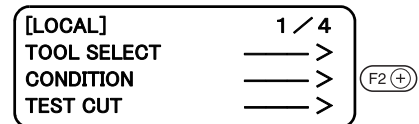

3. Press the **(PAGE +)** key several times until the LCD indicates page 2 of the [MODE SET].

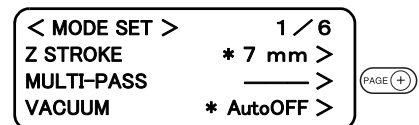

4. Specify a setting for the [ONE STROKE] from among the following.

on, off, sort

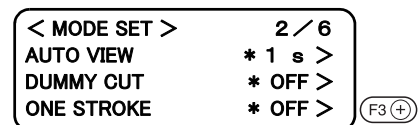

5. Enter the input values.

Press the **(END)** key to enter the input values. If you do not enter the input data, press the **(CE)** key.

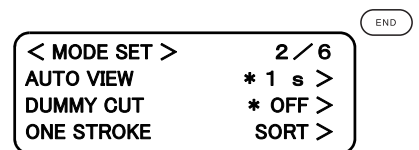

SETTING THE DIRECTION OF ROTATION FOR THE COORDINATE AXIS [MODE SET] > [ROTATE]

In the case where the command origin is established at the lower left of the cutting area, it is necessary to specify the direction of rotation for the coordinate axis in accordance with your CAD.

Set values

+90°: Lower right of the maximum effective cutting area

-90°: Upper left of the maximum effective cutting area

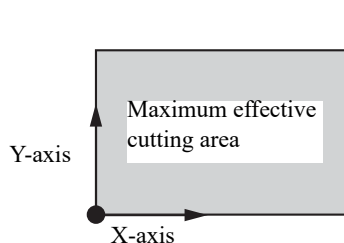

In the case where the command origin is set to the lower left corner

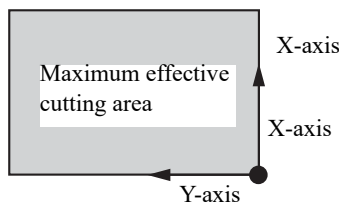

In the case where the direction of rotation is set to 90°

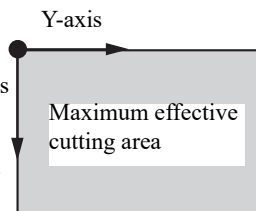

In the case where the direction of rotation is set to -90°

1. Press the **(PAGE+)** key several times until the LCD indicates page 3 of the LOCAL MENU.

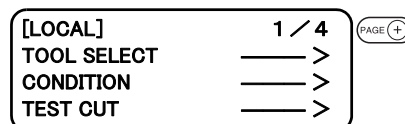

2. Select the [MODE SET].

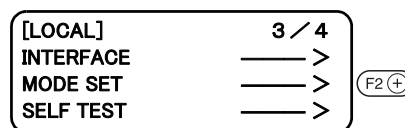

3. Press the **(PAGE+)** key several times until the LCD indicates page 3 of the [MODE SET].

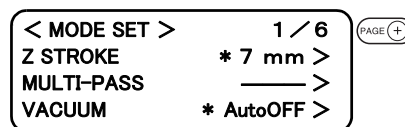

4. Select one of the following as a setting for the [ROTATE].

+90°, -90°

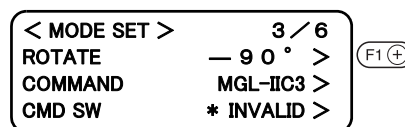

5. Enter the input values.

Press the **(END)** key to enter the input values. If you do not enter the input data, press the **(C/E)** key.

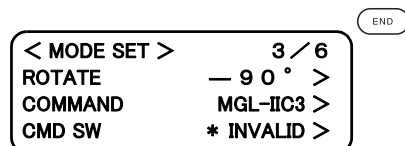

SETTING THE CUTTER STROKE [MODE SET] > [Z STROKE]

For data on a pattern that needs frequent lifting/lowering of the tangential cutter and the marking roller, the lifting amount of the tool should be shortened. This will reduce the total period of time required for cutting.

Set values

7 mm: The tool goes up 7 mm above the surface of a work.

4 mm: The tool goes up 4 mm above the surface of a work.

1. Press the **(PAGE +)** key several times until the LCD indicates page 3 of the LOCAL MENU.

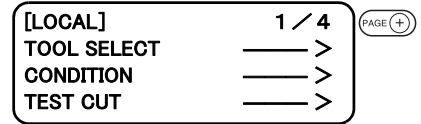

2. Select the [MODE SET].

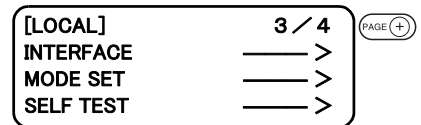

3. Select one of the following as a setting for the [Z STROKE].

7mm, 4mm

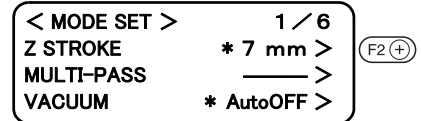

4. Enter the input values.

Press the **(END)** key to enter the input values. If you do not enter the input data, press the **(C/E)** key.

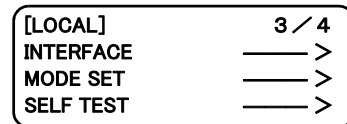
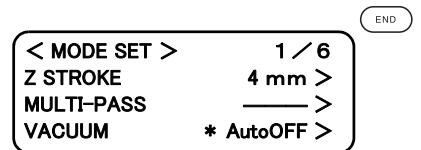

SETTING THE UNIT TO BE USED FOR INDICATION [MODE SET] > [UNIT]

The unit to be used when indicating numerics on the LCD is specified.

Set values

mm: Numerics are indicated in millimeters.

inch: Numerics are indicated in inches.

1. Press the  key several times until the LCD indicates page 3 of the LOCAL MENU.

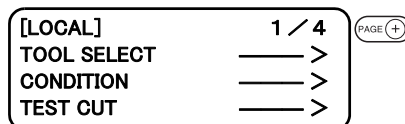

2. Select the [MODE SET].

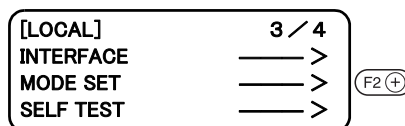

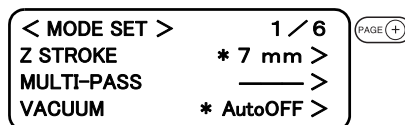

3. Press the  key several times until the LCD indicates page 5 of the [MODE SET].

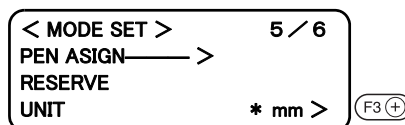

4. Select one of the following as a setting for the [UNIT].
mm, inch



5. Enter the input values.

Press the  key to enter the input values. If you do not enter the input data, press the  key.

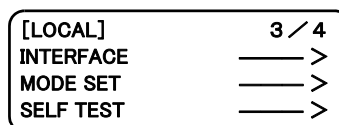
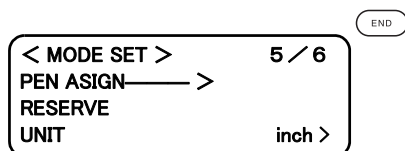

SETTING THE DUMMY CUT OPERATION OF THE SWIEVEL BLADE [MODE SET] > [DUMMY CUT]

In the case where the swivel cutter is selected for the tool, a cutting operation is performed outside the effective cutting area so as to orient the blade tip of the swivel cutter to the advancing direction.

Set values

on: Dummy cut is not performed.

off: Dummy cut is executed.

The illustration below gives the position at which dummy cut is performed and the size of dummy cut pattern.

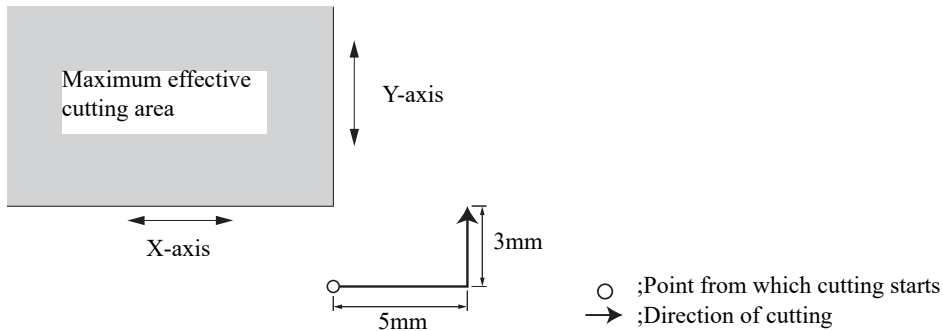

1. Press the **(PAGE +)** key several times until the LCD indicates page 3 of the LOCAL MENU.

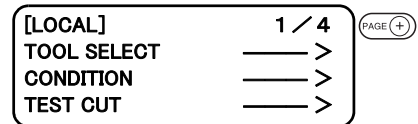

2. Select the [MODE SET].

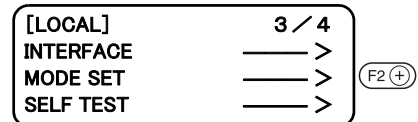

3. Press the **(PAGE +)** key several times until the LCD indicates page 2 of the [MODE SET].

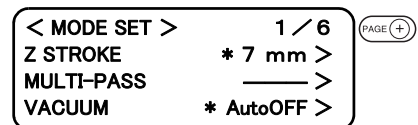

4. Select one of the following as a setting for the [DUMMY CUT].
 off, on

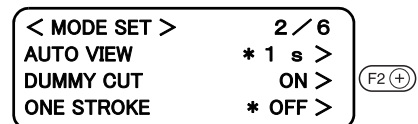

5. Enter the input values. Press the **(END)** key to enter the input values. If you do not enter the input data, press the **(C E)** key.

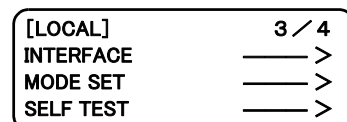
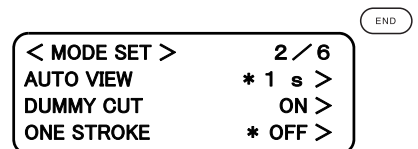

ALIGNMENT OF MECHANICAL AXES TO RULED LINES PRINTED [AXIS ALIGN]

If ruled lines such as scales are printed on a work, mechanical axes (X-axis, Y-axis) of the device need to be aligned to them.

To set the mechanical axes, firstly establish an origin at the leftmost ruled line printed on the work in terms of the X-axis direction. Secondly, enter the point (point A) of the rightmost ruled line to be used to enter the inclination of ruled lines.

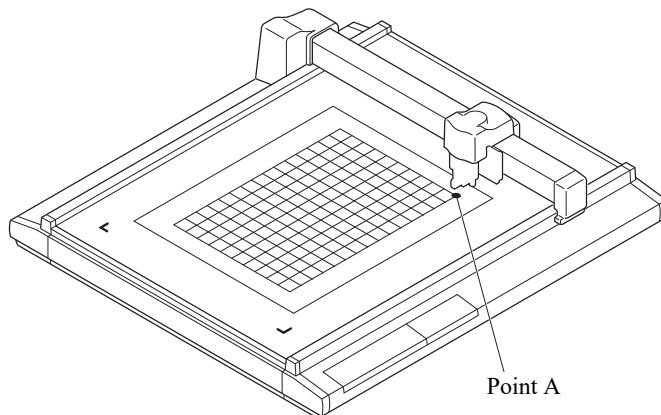

1. Cause the device to enter the LOCAL state.

If the device is in the REMOTE state, press the  key.

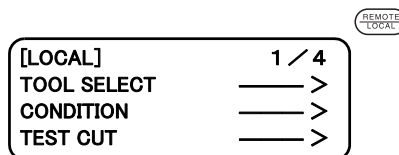

2. Establish an origin at the leftmost one of the ruled lines printed on the work. ( P.2-47)

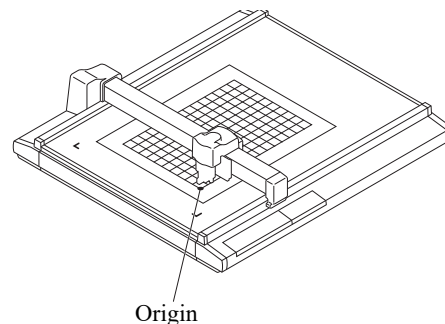

3. Press the  key several times until the LCD indicates page 3 of the LOCAL MENU.

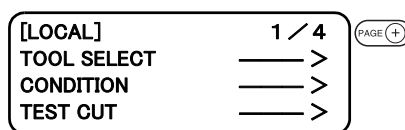

4. Select the [AXIS ALIGN].

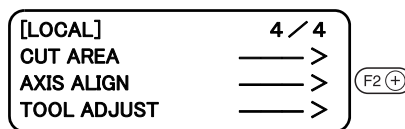

5. Align the tip of the tool to point A.

Operate the jog keys to align the tip of the tool to the rightmost one of the ruled lines on the work.

Increase/decrease the speed and lift/lower the tip of the tool when necessary until point A is reached.



< AXIS ALIGN >	[mm]
00.00	00.00
SPEED	FAST >
CUTTER	UP >

F2 (+)
F3 (+)

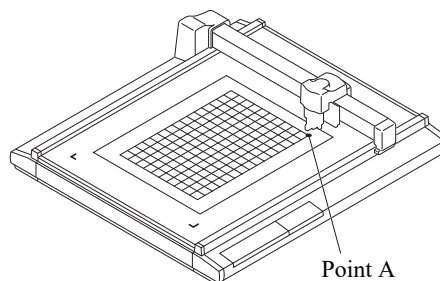

6. Enter point A.

Press the **END** key to enter the input values. If you do not enter the input data, press the **C.E** key.

< AXIS ALIGN >	[mm]
912.60	61.0
SPEED	FAST >
CUTTER	UP >

END

EXPAND THE CUTTING AREA [EXPANDS]

The Expand function expands the cutting area.

In case of Sensor equipped model, and not using Mark detect function, able to expand the cutting area 30mm. This function only supports S (sensor equipped) model.



- To use the square mark detect function with the sensor equipped model, set to OFF.



- When using a Y shaft work guide plate, and head B/C is selected, in the case of expand is set to ON, Y shaft work guide plate interrupt the cut area. To prevent hitting head B/C tool and work guide plate, not to use a work guide or use a pin.

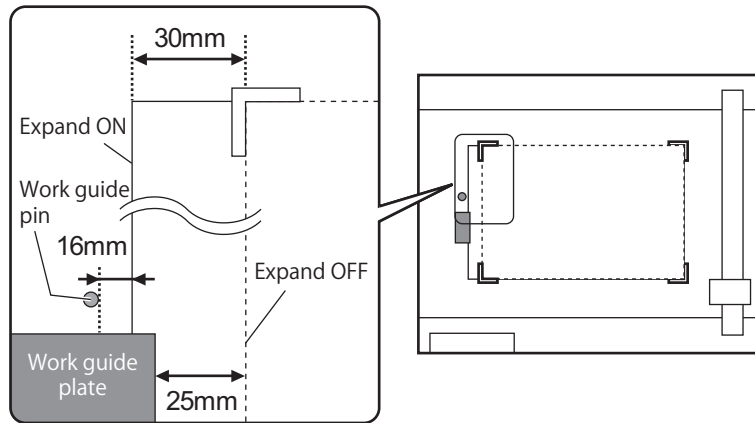

- Display the LOCAL menu page3. Press the **PAGE(+)** key several times.

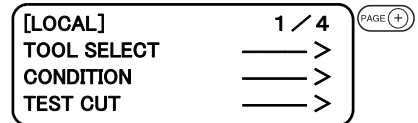

- Select [MODE SET]

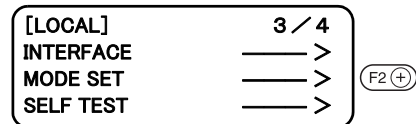

- Display the MODE SET page 6. Press the **PAGE(+)** key several times.



- In the case of no sensor model, page 6 is not displayed.

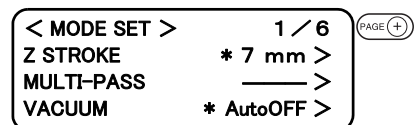

- Set the [Expand] OFF/ON

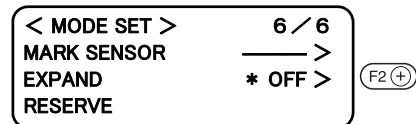

- Register the value. Press the **END** key to enter the value.

If you do not enter the input data, press the **GE** E key. Confirmation screen of head move is displayed.



6. Press the  key to start origin initialize operation.



- Every time change the EXPAND setting, origin initialize operation executed
- In the case of set to ON, mark detect setting becomes OFF automatically.
- To use the mark sensor, set the EXPAND to OFF, then set the mark detect setting. (☞ P. 5-2, P. 5-11)

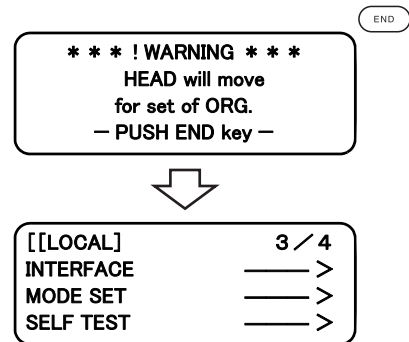

CHAPTER 5

REGISTER MARK DETECT FUNCTION

This chapter describes “register mark detect” function. Register mark detect function only supports S (sensor equipped) model.

Table of Contents

<i>SETTING OF REGISTER MARK DETECT</i>	5-2
<i>PRECAUTIONS IN PREPARING DATA WITH REGISTER MARK</i>	5-3
<i>SETTING OF REGISTER MARK DETECT OPERATION</i>	5-11
<i>CONTINUOUS CUT WITH REGISTER MARK</i>	5-17
<i>INITIALIZE THE REGISTER MARK SCALE ADJUSTMENT [SC.CLR]</i>	5-18

SETTING OF REGISTER MARK DETECT

This function detects a register mark automatically. Use this function to correct the inclination of the sheet loaded, the position of plotting origin, and the distance between register marks and then cut the contour of printed image. If the firmware version is older than 2.50, the register mark is circular.

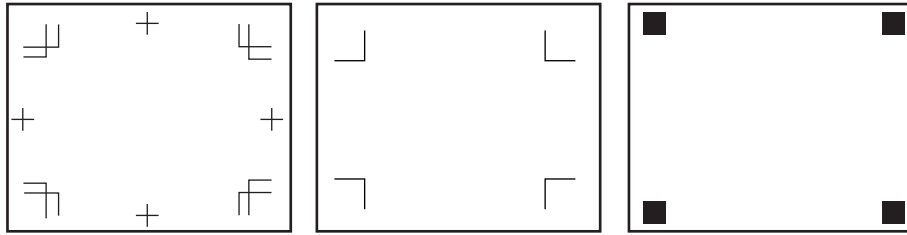

How to display the register mark setting on LCD

1. Display the LOCAL menu page 3

Press key several times.

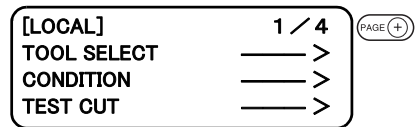

2. Select [MODE SET]

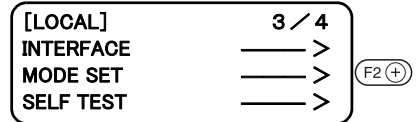

3. Display the MODE SET page 6

Press key several times.



- In the case of no sensor model, page 6 is not displayed.

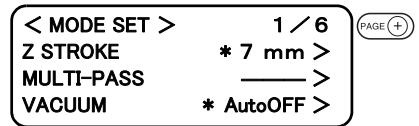

4. Select [MARK SENSOR]



- If [expand] is set to ON, can not select Mark sensor. Change th68.) (P. 4-15)

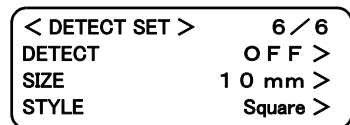
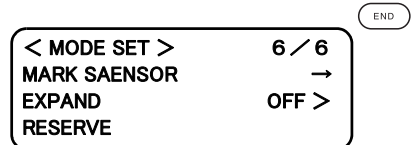

PRECAUTIONS IN PREPARING DATA WITH REGISTER MARK

There are some limitations on preparing data with register marks. In order to make full use of this function, read the following instruction carefully and prepare data with register mark.



- The register mark described here is intended to detect the sheet inclination and the lengths along the X and Y axes. It is not a mark for trimming.

Size of the square mark

Each side of the diameter of square mark must be in the range of 5 to 30mm (5mm increments).

Refer to [The size of, and the distance between, register marks] (☞ P. 5-9) for the relationship between the data and the length of one sided of a register mark.

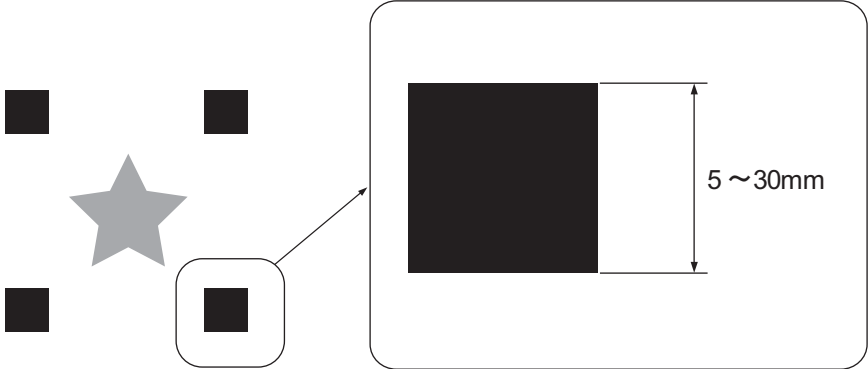

Size of the register mark

Each side of the single register mark must be 5 - 30mm.

Each side of the double register mark must be 10 - 30mm.

The line width of mark shall be equal to or more than 0.2 mm and equal to or less than 0.5 mm.

Refer to [The size of, and the distance between, register marks] (P. 5-9) for the relationship between the data and the length of one sided of a register mark.

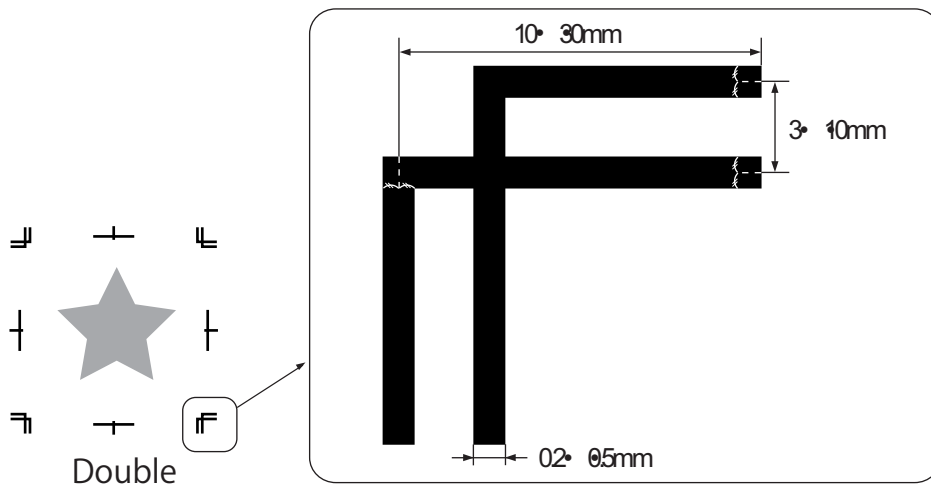
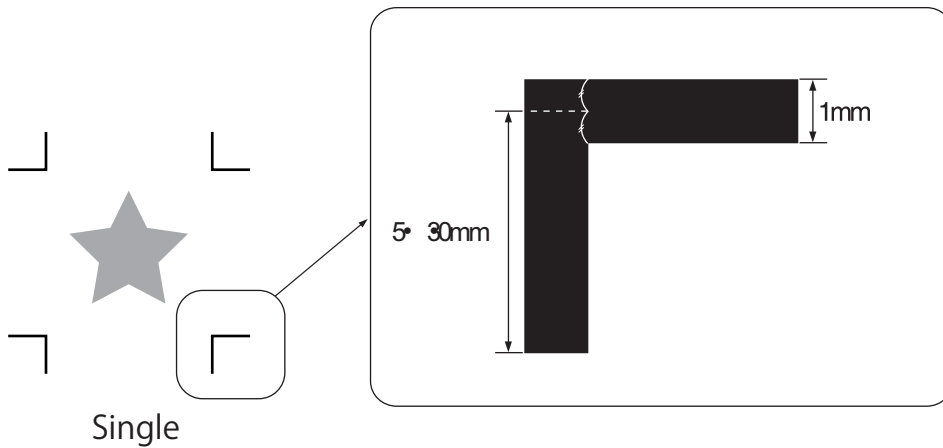

The area where register marks and designs can be arranged

The TP1 starting position must be 10mm or more away from the work left edge, and 30 mm or more away from the Available cutting area.

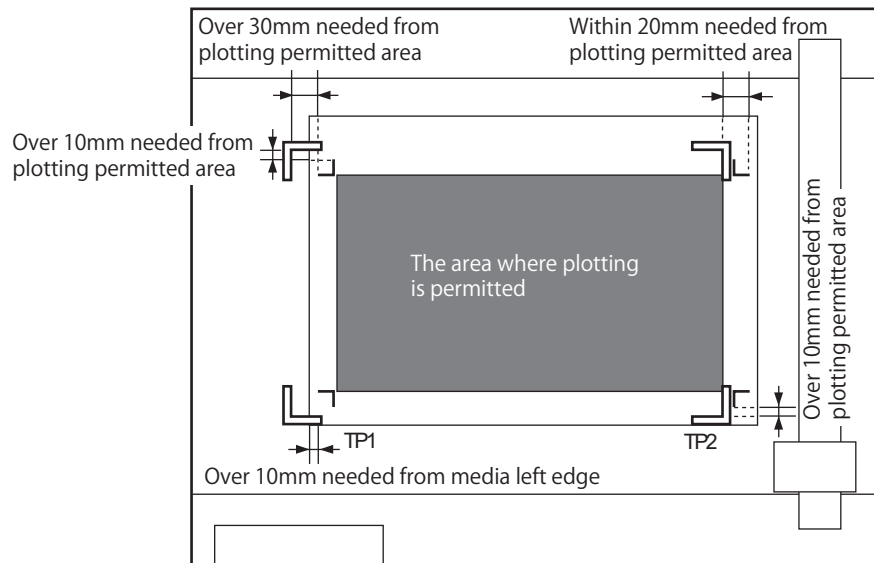
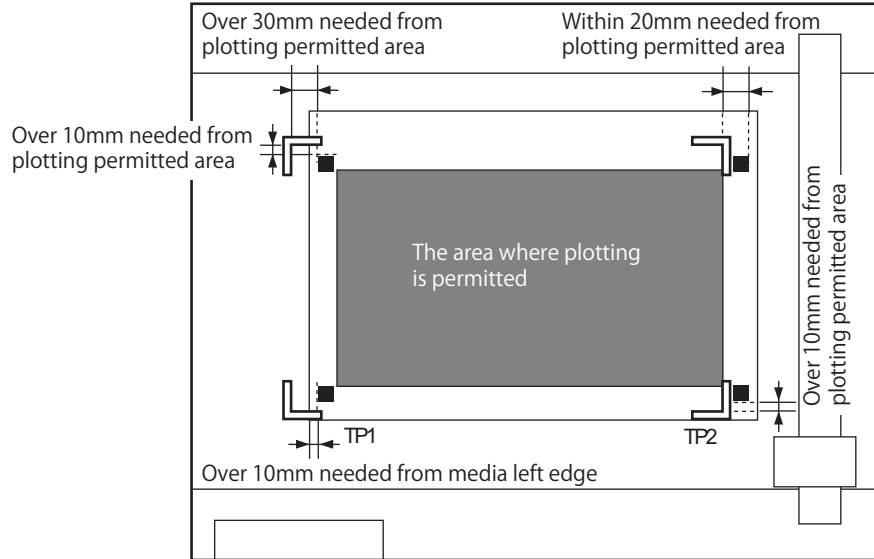

No-plotting area around the register marks

There must be no data or stain around the register mark; otherwise a wrong origin may be detected or a mark read error can occur.



- If a wrong mark origin is detected, the cutting will be performed in a wrong area.

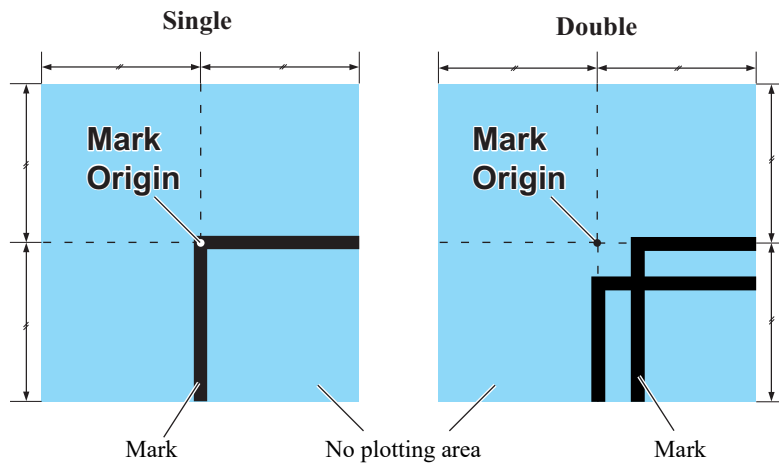
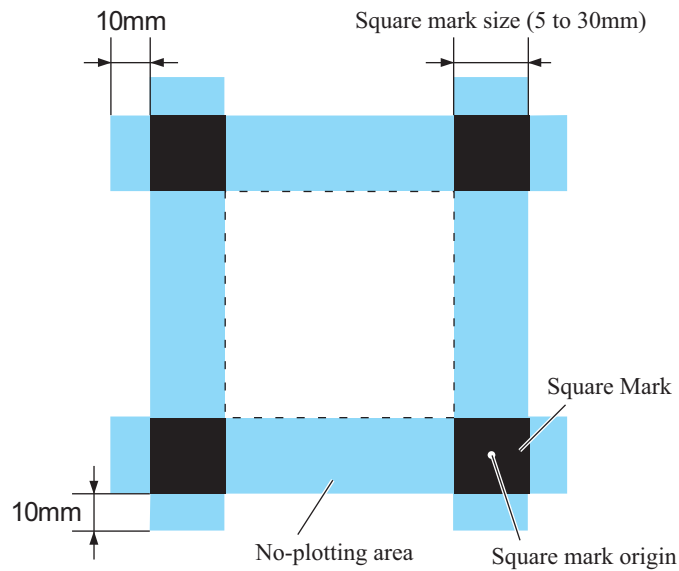

Example of cause of wrong detection1:

Layer of the offset printing is misaligned .



- When printing with offset, square mark is printed in one color.

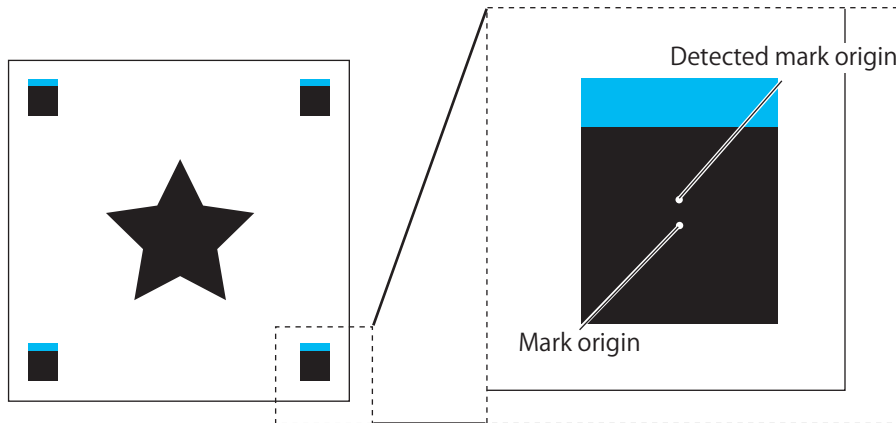

Example of cause of wrong detection2:

The distance between square marks (TP3 of pattern A and TP1 of pattern C, or TP2 of pattern A and TP1 of pattern B) is less than 10mm.

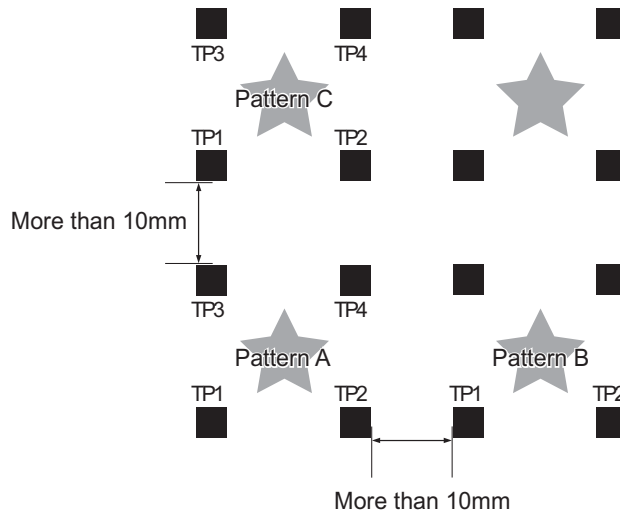

Example of cause of wrong detection3:

The distance between register marks(TP2&TP1, TP4&TP2) is smaller than the mark length.

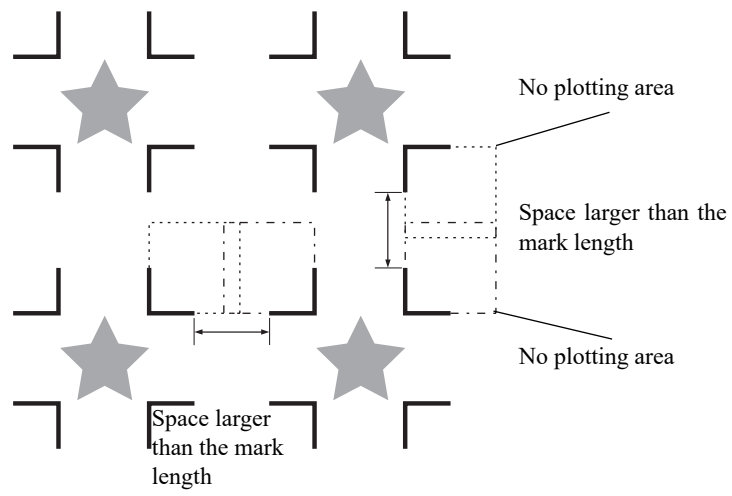

The size of, and the distance between, register marks

The size (B) of a register mark suited for the distance (A) between the mark is as shown below. If the mark size (B) is too small relative to the distance (A), the marks may not be detected correctly. Be sure to prepare the register marks with an appropriate size.

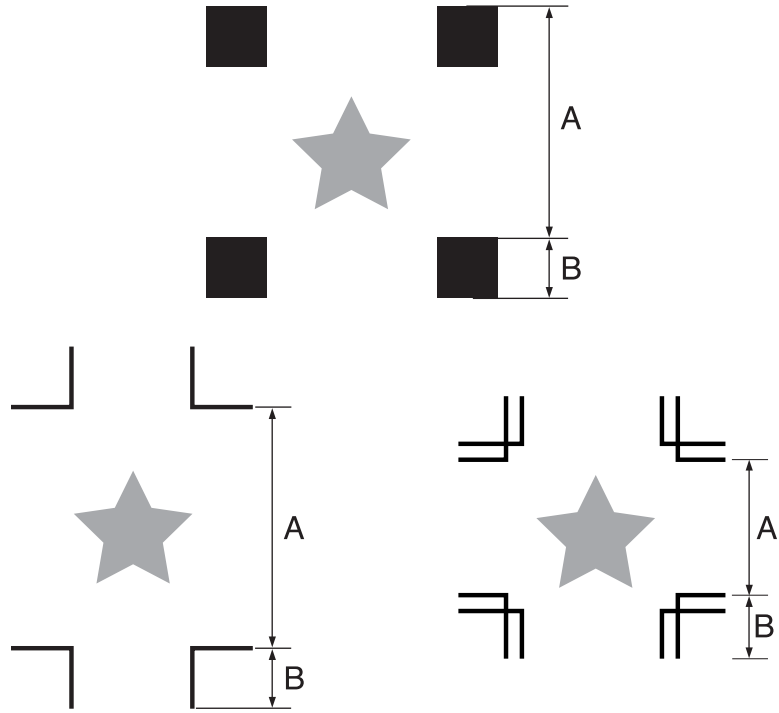

A	200mm	500mm	1000mm	1500mm	1501mm
B	5	10	15	20	30

(mm)

Color of Register mark

Black or white is recommended for the register mark color.

Other colors can be detected. However make sure to not use the same color as media(work).

It is recommended to confirm ahead, either register mark is detectable.

The register mark will not be detected correctly if there is a strong glossy, pattern (hair line) on the work, or depending on the media(work) color.

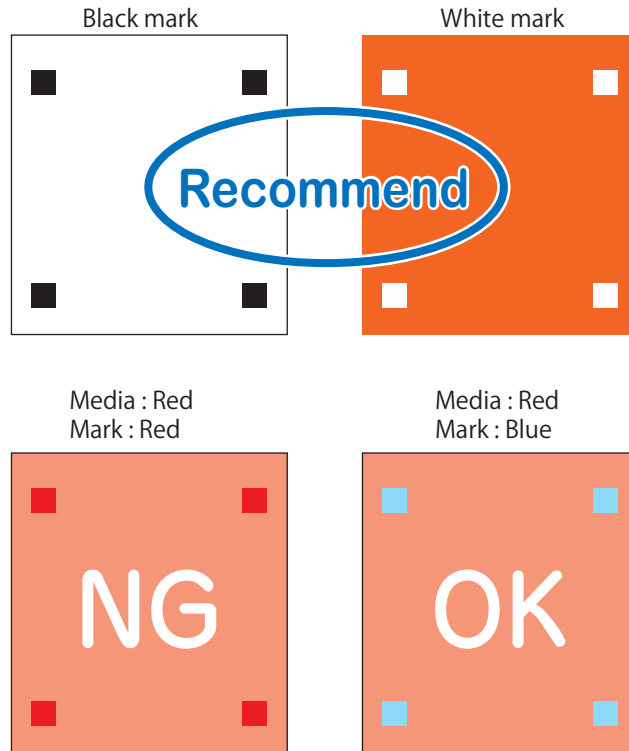

Register mark Blurred

If the mark is blurred, a wrong mark origin can be detected, thus resulting in deviated cutting.



SETTING OF REGISTER MARK DETECT OPERATION

Precautions on register mark detection

- To ensure that the distance between register marks is equal to the cutting length, input the distance between the printed marks found by the mark detecting function. (☞ P. 5-10)
- Once the plotter detects marks, it will set the origin at the location of TP1.
You can change the position of the origin to a different location using jog keys ; the origin at the new location supersedes the origin at TP1.
- The rotating function is rendered ineffective.
- The STROKE function is rendered ineffective.

How to display the register mark setting on LCD

1. Display the <DETECT SET>

(☞ P. 5-2)

```
< DETECT SET >      1 / 2
DETECT              O F F >
SIZE                1 0 mm >
STYLE               Square >
```

2. Set the [DETECT], [Size], and [STYLE].

(☞ P. 5-12)

```
< DETECT SET >      1 / 2
DETECT              O F F >
SIZE                1 0 mm >
STYLE               Square >
```

F1 (+)
F2 (+)
F3 (+)

3. Press **PAGE+** key several times to display the <DETECT SET> menu page2.

```
< DETECT SET >      1 / 2
DETECT              1pt >
SIZE                1 0 mm >
STYLE               Square >
```

PAGE (+)

4. Set the [X COPY], [Y COPY], and [SCALE]

(☞ P. 5-12)

5. Press the **END** key to register the setting.

If you do not want to register, press the **CE** key.

```
< DETECT SET >      1 / 2
X COPY              1 >
Y COPY              1 >
SCALE              O F F >
```

F1 (+)
F2 (+)
F3 (+)

Settings for detection of marks

Make the settings of the following five functions to detect register mark.

Detect Square Mark : The higher the number of detected points, the higher the cutting accuracy.

Select "1pt" when using FuneCut.

Setting	Description
OFF	Select this setting for cutting a normal sheet, not for cutting the outline. If set the Expand mode to valid, this setting is automatically set to OFF.
1pt	Detects the TP1. Sets only the origin.
2pt	Detects the two register marks TP1 and TP2. Performs the skew compensation and the scale compensation in the Y direction.
3pt	Detects the three register marks TP1, TP2, and TP3. Performs the skew compensation and the Yscale compensation in the work X direction and Y direction.
4pt	Detects the four register marks TP1, TP2, TP3, and TP4. Performs the skew compensation, and the scale compensation in four points.

Size :

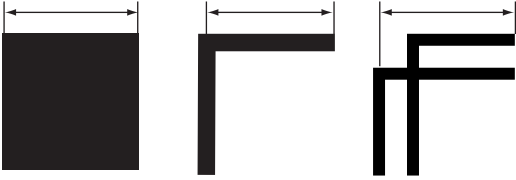
Setting	Description
5 to 30mm	Set the side length of register mark. 

Shape :

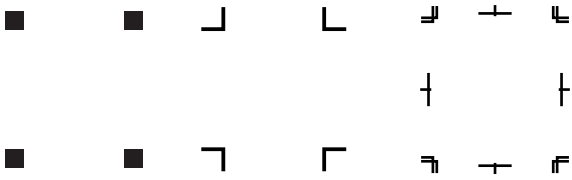
Setting	Description
Square Single Double	Select the register mark shape from below 3 types.  <div style="display: flex; justify-content: space-around; width: 100%;"> Square Single Double </div>

SETTING OF REGISTER MARK DETECT OPERATION

X copy Ycopy :

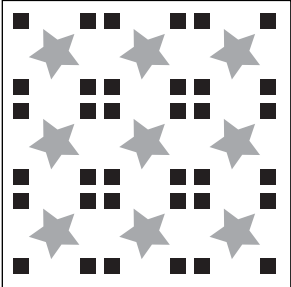
Setting	Description
1 to 99	<p>Effective when the same pattern is multi-printed at regular intervals. Cuts automatically the preset number of sheets while detecting register marks consecutively based on the first data.</p> <div style="display: flex; align-items: center;">  <div style="margin-left: 20px;"> <p>When the number of copies can be set on the application software, like on the supplied FineCut, set the value to [1]</p> </div> </div>

SCALE : Select “OFF” when using FineCut.

Setting	Description
OFF	The plotter will not perform scale compensation when detect the register mark.
AFTER	With this setting, enter the data X Y size after executing the register mark detection and perform scale compensation. (☞ P. 5-16) If Mark detect is set to “1pt”, scale compensation is not executed.
BEFORE	With this setting, enter the data X Y size before executing the register mark detection and perform scale compensation. (☞ P. 5-16) If Mark detect is set to “1pt”, scale compensation is not executed.

Settings for detect

Make sure that work is not curled.

When using a cutting software having no mark function, use a work which has neither stains nor images in the area of TP1 - TP3 and TP1-TP2.

Check sheet skew with a light pointer

Press  key on the jog mode, the light pointer will light up.

Move the carriage between TP1 and TP2 with a jog key to check the sheet skew against the line of the light pointer. Correct the sheet skew by aligning with the line.

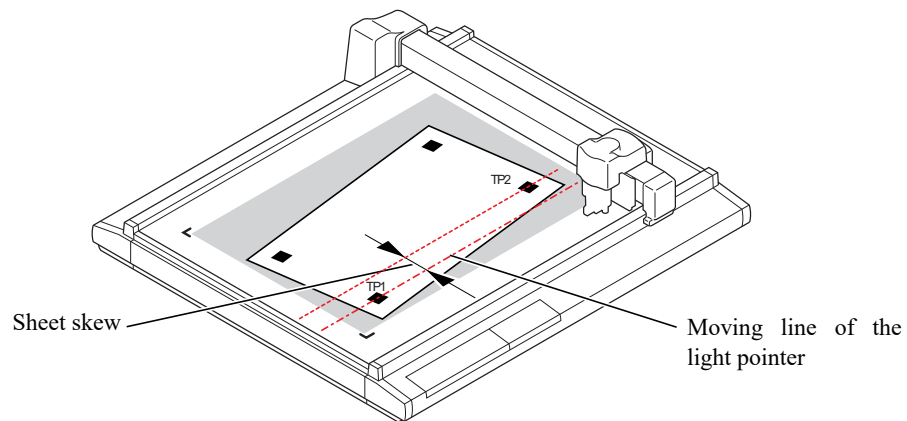

How to detect Register mark

1. Set the work to the plotter.

2. Press **END** key on the [Local] mode.
Display changes to [DETECT] mark mode

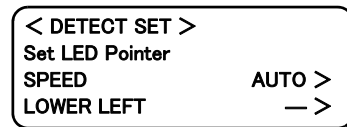
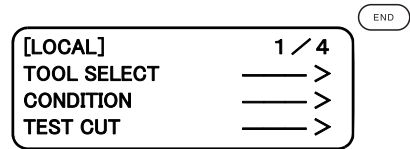

3. Move and align the light pointer on the center of the TP1 vertical line precisely with jog key. In the case of square mark, move to around the center.



- If [SPEED] is set to AUTO, speed automatically changes while pressing the jog key.
- Press the **F3** key enables to move the head to LL (Lower-Left).

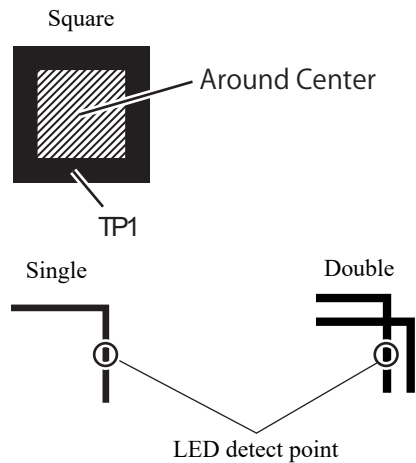



4. Press **END** key.
Start detecting a register mark.



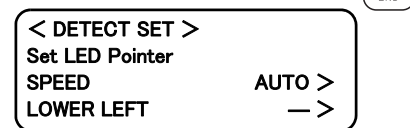

- When register mark detection failed, error is displayed. Reset the work to the plotter.
- If [SCALE] is set to “BEFORE”, LCD of Step5 is displayed before register mark detection.



5. After detect the register mark, display changes to Scale compensation. If the data and detected length differs, set with   key.

< SCALE SET >	mm
1-2 (X)	400.8>
1-3 (Y)	149.1>







- If [Scale] is set to OFF, <SCALE SET> is not displayed.
- If [MARK DETECT] is set to 2Pt, X length is not displayed.
- If [MARK DETECT] is set to 1Pt, <SCALE SET> is not displayed.

6. Press  key.

Plotter return to Local mode.

If press the , scale set is invalid.

< SCALE SET >	mm
1-2 (X)	400.0>
1-3 (Y)	150.0>





- If [SCALE] is set to “BEFORE”,Mark detect starts by pressing  key.

CONTINUOUS CUT WITH REGISTER MARK

When using a cutting software “FineCut,” continuous cut is available. Register mark on a printed data should be only one set.

1. Configure the FineCut setting, and start plot.

Select [Single mode] and set the number of Repeat.

For more setting detail, refer to the FineCut operation manual.

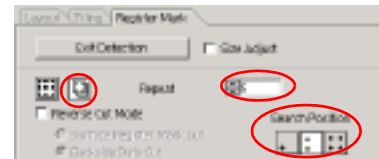

2. When cutting of first page finished, change the work and press

VACUUM.

If press the **CE**, continuous cut stops.

[REMOTE]
Exchange SHEET
V A C : Resume
C E : Abort

3. Detect the register mark. (☞ P. 5-11)

Once register mark detect is done, copy is started. Repeat Step2 and 3 until the specified repeat number.

[REMOTE]
Set LED Pointer
SPEED AUTO >
Head Move to LL ->



[REMOTE]
* Auto Copy Mode *
2 / 3
0

4. When cut is completed, head return to the home position automatically, and return to [Local mode]

[LOCAL] 1 / 4
TOOL SELECT —>
CONDITION —>
TEST CUT —>

INITIALIZE THE REGISTER MARK SCALE ADJUSTMENT [SC.CLR]

When using a cutting software other than “FineCut,” need to initialize the adjustment value after cutting. [SC.CLR] initialize the shaft adjustment value and scale adjustment value. If cut the data where no register mark positioned without initialize the adjustment value, cut may misaligned.

1. If it is in the REMOTE mode, press  key to enter the ROCAL mode.

While processing, it will be interrupted.

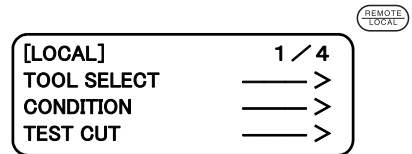

2. Display the ROCAL menu page 2.

Press  key several time.

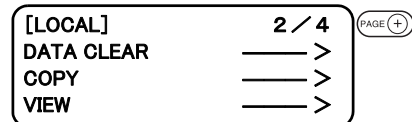

3. Select [DATA CLEAR].

Press  key.

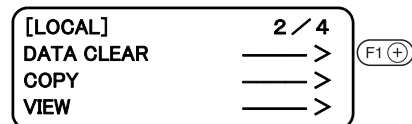

4. Execute [ORGkey to SC.CLR]

To cancel the [SCALE CLEAR], press the  key, it return to the step2,

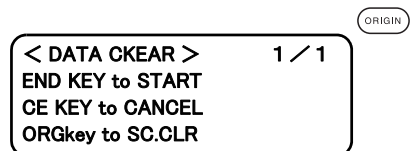

CHAPTER 6

SELF-TEST

This chapter describes “self-test” function.

Table of Contents

<i>CONFIRMATION OF CUTTING QUALITY ONLY BY THE SINGLE UNIT OF THE DEVICE [SELF TEST].....</i>	<i>6-2</i>
<i>DUMP TEST [SELF TEST].....</i>	<i>6-5</i>

CONFIRMATION OF CUTTING QUALITY ONLY BY THE SINGLE UNIT OF THE DEVICE [SELF TEST]

The “self-test” function is executed to determine where a trouble has occurred; i.e., either the command from the computer or the single unit of this device. The “self-test” function is used to conduct plotting, cutting and marking of eleven different kinds of samples independently by the single unit of this device without using any command from the computer. If cutting quality is poor, change the cutting conditions and adjust tools. If the cutting quality cannot be improved after the aforementioned adjustments, contact your local dealer or MIMAKI office.

- Refer to Appendix C for sample.

Self-test items	Description
CUT QUALITY 1	The device actuates using the tool selected by using the tool selecting function. The sample used is a family emblem consisting of various line segments.
CUT QUALITY 2	The sample used is a pattern intended for the apparel industry. The device first plots inner lines of the pattern. Then, it cuts outer lines of the pattern. (Effective for the head models excluding the P-head model)
ASCII DUMP	The device plots data transmitted from the computer with the ASCII code. This is conducted to check for abnormal conditions of the data.
SAMPLE (COATED)	This self-test is executed when creating a paper ware sample with coated board (approximately 0.5 mm thick). Firstly, the device conducts marking, then cuts the coated board along the outer shape of the pattern. To perform this test, coated board of which size is equal to or more than A4 size is required. (Effective only for the TD model)
Sample (E CORRUGATED)	This self-test is executed when creating a paper ware sample with E corrugated fiberboard (approximately 2 mm thick). Firstly, the device conducts marking, then cuts the coated board along the outer shape of the pattern. To perform this test, coated board of which size is equal to or more than A3 size is required. (Effective only for the TD model)
Sample (B CORRUGATED)	This self-test is executed when creating a paper ware sample with B corrugated fiberboard (approximately 3 mm thick). Firstly, the device conducts marking, then cuts the coated board along the outer shape of the pattern. To perform this test, coated board of which size is equal to or more than A2 size is required. (Effective only for the TD model)
R = 3	The device cuts a circle of which radius is 3 mm.
R = 5	The device cuts a circle of which radius is 5 mm.
R = 10	The device cuts a circle of which radius is 10 mm.
R = 20	The device cuts a circle of which radius is 20 mm.
R = 50	The device cuts a circle of which radius is 50 mm.
R = 100	The device cuts a circle of which radius is 100 mm.
PARAMETER DUMP	The device plots a pattern according to the cutting conditions independently established on it.

CONFIRMATION OF CUTTING QUALITY ONLY BY THE SINGLE UNIT OF THE DEVICE [SELF

Cutting quality * / Sample * * * / Circle cutting R = * *

The following describes how to execute the self-test functions.

When executing the cutting quality test and the sample test, the pen number assigning function will be rendered effective. It is necessary, therefore, to set the related values to the initial ones.

Pen No.	T	TD/TF
1	Head	B
	Tool	Cutter 1
2	Head	B
	Tool	Cutter 1
3	Head	B
	Tool	Cutter 1
4	Head	A
	Tool	Cutter 1
5	Head	A
	Tool	Swivel cutter
6	Head	A
	Tool	Pen

1. Establish an origin at a location where the self-test is to be performed.

 P. 2-36)

2. Invoke the 3rd page of the LOCAL menu on the screen.

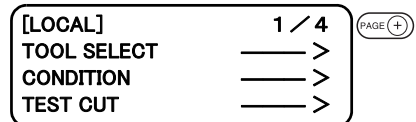

3. Select the [SELF TEST].

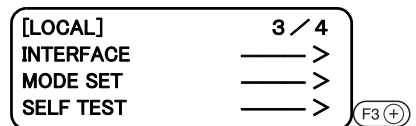

4. Invoke the sample to be executed on the display.

Self-test screen consists of five pages.

Press the **PAGE (+)** key to call a page that contains the sample to be executed on the LCD.

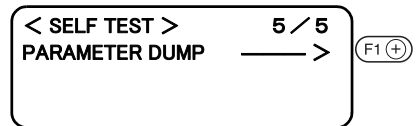
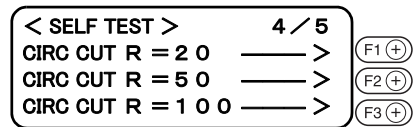
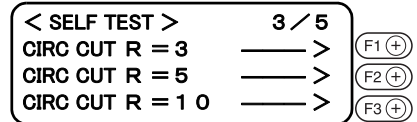
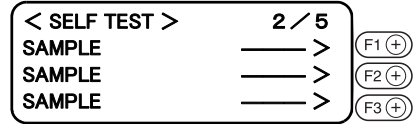
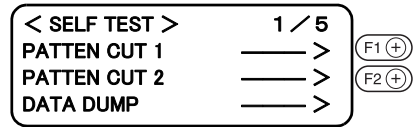

5. Select the sample to be executed.

The illustrated LCD is given when the [PATTERN CUT 1] is selected.

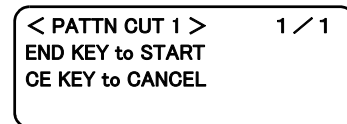

6. Execute the self-test.

Press the **END** key to execute the function.

If you do not want to execute it, press the **CE** key.

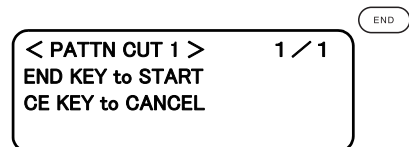

DUMP TEST [SELF TEST]

Executing the data dump

Prepare a pen and a sheet of A3 size or larger paper. If the size of paper is smaller than A3 or smaller, the device will plot a pattern beyond the paper.

When this setting is selected, the tool will be automatically changed to a pen. Be sure to install a pen to the head A in prior.

1. Select a pen for the tool using the tool selecting function. (👉 P. 2-18)
2. Place a sheet of A3 or larger paper in landscape orientation on the device.

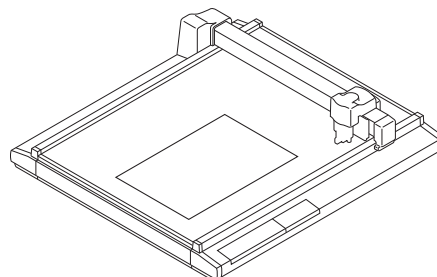

3. Establish an origin at the left corner of the paper.

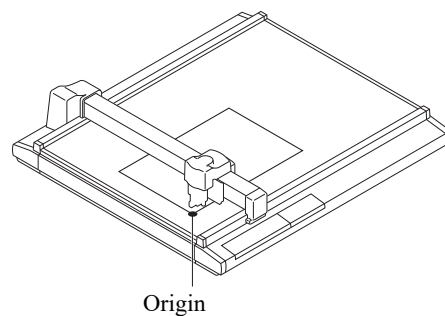

4. Invoke the 3rd page of the LOCAL menu on the screen.

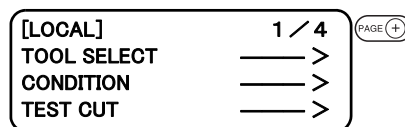

5. Select the [SELF TEST].

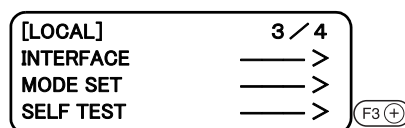

6. Select the [DATA DUMP].

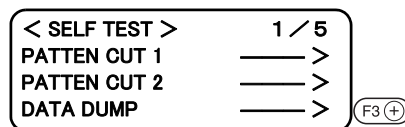

7. Execute the [DATA DUMP].

The tool travels to the upper left of the paper.

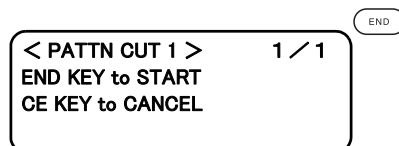
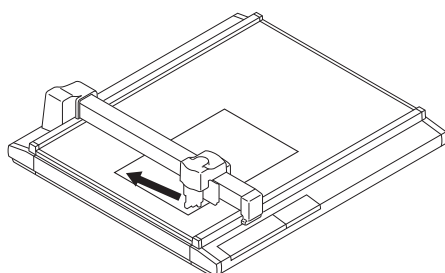

8. Check the position of the paper.

Check to be sure that the tip of the pen rests on the upper left of the paper.

If the tip of the pen is positioned any position other than the upper left of the paper, align the upper left of the paper to the tip of the pen.

```
< DATA DUMP >      1 / 1
A3 LOCAL CONFIR      →
* UPPER LEFT         SET
* MARGIN  1 0 * 1 0 mm
```

9. Execute the [DATA DUMP].

The machine plots communication conditions and stops.

```
< DATA DUMP >      1 / 1
A3 LOCAL CONFIR      →
* UPPER LEFT         SET
* MARGIN  1 0 * 1 0 mm
```

F1 (+)

10. Transmit data from the computer to the device.

The device plots data transmitted from the computer with the ASCII code.



- To abort, press the  key to temporarily interrupt the operation, then execute the data clear function.

Execution of the parameter dump

Prepare a pen and a sheet of A3 size or larger paper.

If the size of paper is smaller than A3 or smaller, the device will plot a pattern beyond the paper.

When this setting is selected, the tool will be automatically changed to a pen. Be sure to install a pen to the head A in prior.

1. Select a pen for the tool using the tool selecting function. (☞ P. 2-18)

2. Place a sheet of A3 or larger paper in landscape orientation on the device while aligning the lower left corner of the paper to the origin marker label.

Be sure to align the lower left corner of the paper to the origin marker label adhered to the lower left of the cutting panel.

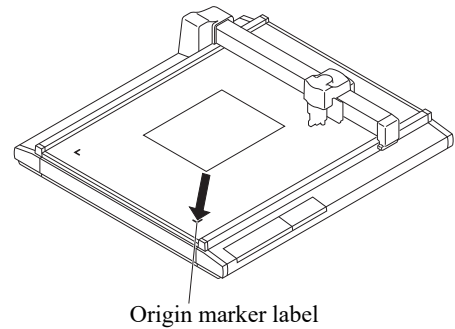

3. Invoke the 3rd page of the LOCAL menu on the screen.

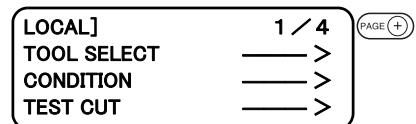

4. Select the [SELF TEST].

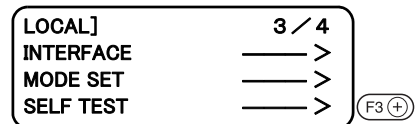

5. Invoke the fifth page of the self-test screen on the LCD.

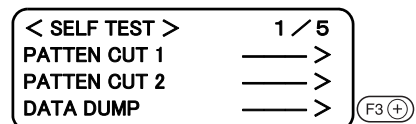

6. Select the [PARAMETER DUMP].

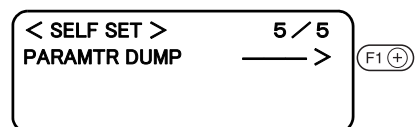

7. Execute the [PARAMETER DUMP].

The head travels to the upper left of the paper to start plotting the parameters.



- To abort, press the  key to temporarily interrupt the operation, then execute the data clear function.

CHAPTER 7

APPENDIX

This appendix describes the replacement of blades, menu structure and the patterns.

Table of Contents

<i>A. REPLACING THE BLADE TIPS</i>	7-2
<i>B. LOCAL MENU STRUCTURE</i>	7-5
<i>C. OUTPUT SAMPLES</i>	7-9
<i>D. SPECIFICATIONS</i>	7-13
<i>E. MAINTENANCE</i>	7-15
<i>F. OPTIONAL ACCESSORIES</i>	7-17

REPLACING THE BLADE PROTRUSION

The following describes how to replace the blade tips of the tangential cutter and swivel cutter.

Tangential cutter blade

Follow the procedure described below to change the special blade and the high-speed steel blade.



- Keep your fingers away from the blade tip. Touching the blade tip can injure your fingers.

Grind the blade tip and crest of the high-speed steel blade using a hand lapper supplied with the device as an accessory.

Ground crest will allow secure installation of the blade in the holder. Grinding the blade tip (to round it) will improve durability.

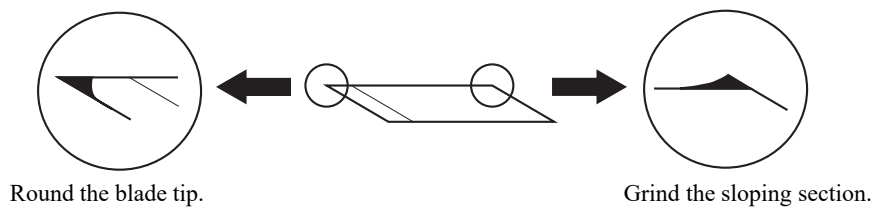

Gently rub the blade tip with the hand lapper while checking how far it is ground.

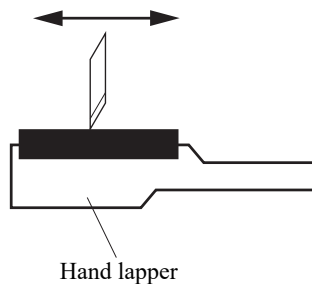

1. Loosen the cutter stopper.

Turn the cutter stopper counterclockwise to loosen it.

Cutter stopper



2. Replace the blade tip with a new one.

Hold the blade tip with a pair of tweezers supplied with the device as an accessory.

Insert the blade tip into the holder while carefully checking the orientation of the blade tip.

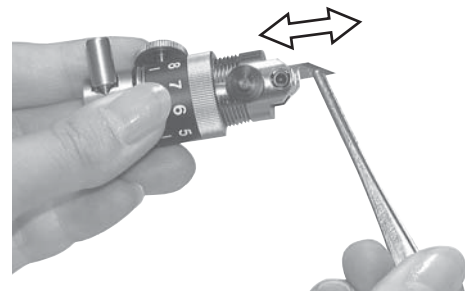

Insert the blade tip as illustrated in the sketch on the left.

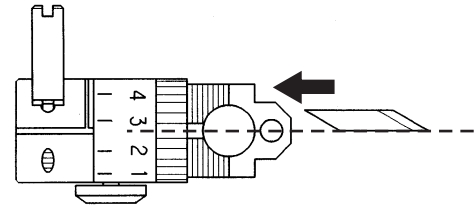

3. Tighten the cutter stopper.

Turn the cutter stopper clockwise to tighten it.

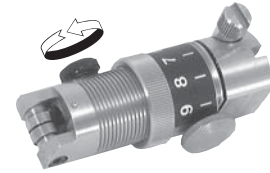

4. Adjust the projecting amount of the blade tip.

Refer to the explanation given in the “Adjusting the blade.” (☞ 2.12. (☞ P. 2-10)

Swivel cutter blade

Follow the procedure given below to replace the blade tip of the swivel cutter.

1. Loosen the locknut.

Turn the locknut counterclockwise to loosen it.

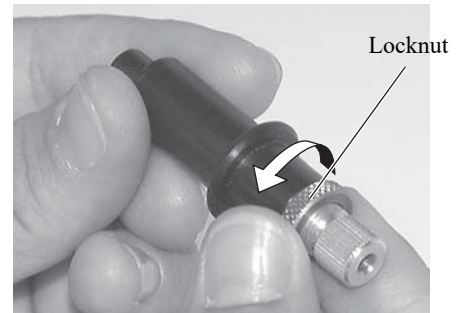

2. Turning the adjusting knob counterclockwise, draw out the holder B from the holder A.

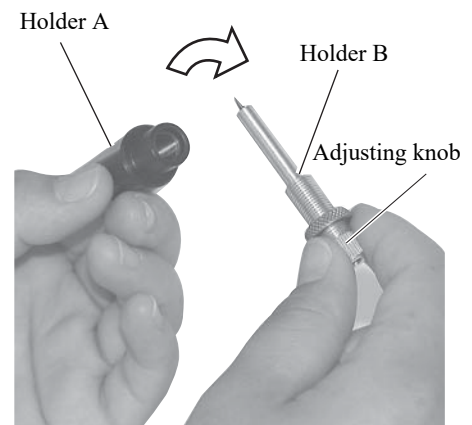

3. Replace the blade tip with a new one using a pair of tweezers.

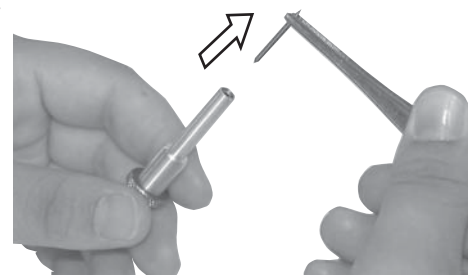

-
4. **Turning the adjusting knob clockwise, put the holder B in the holder A.**

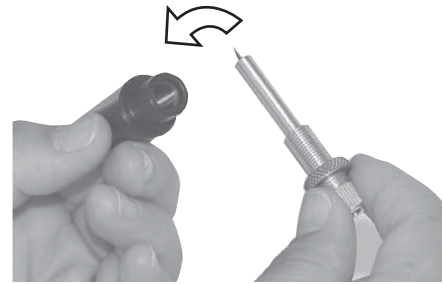

5. **Tighten the locknut.**

Turn the locknut clockwise to tighten it. Refer to the explanation given in the "Adjusting the blade." (P. 2-10)



B. LOCAL MENU STRUCTURE

T-head model

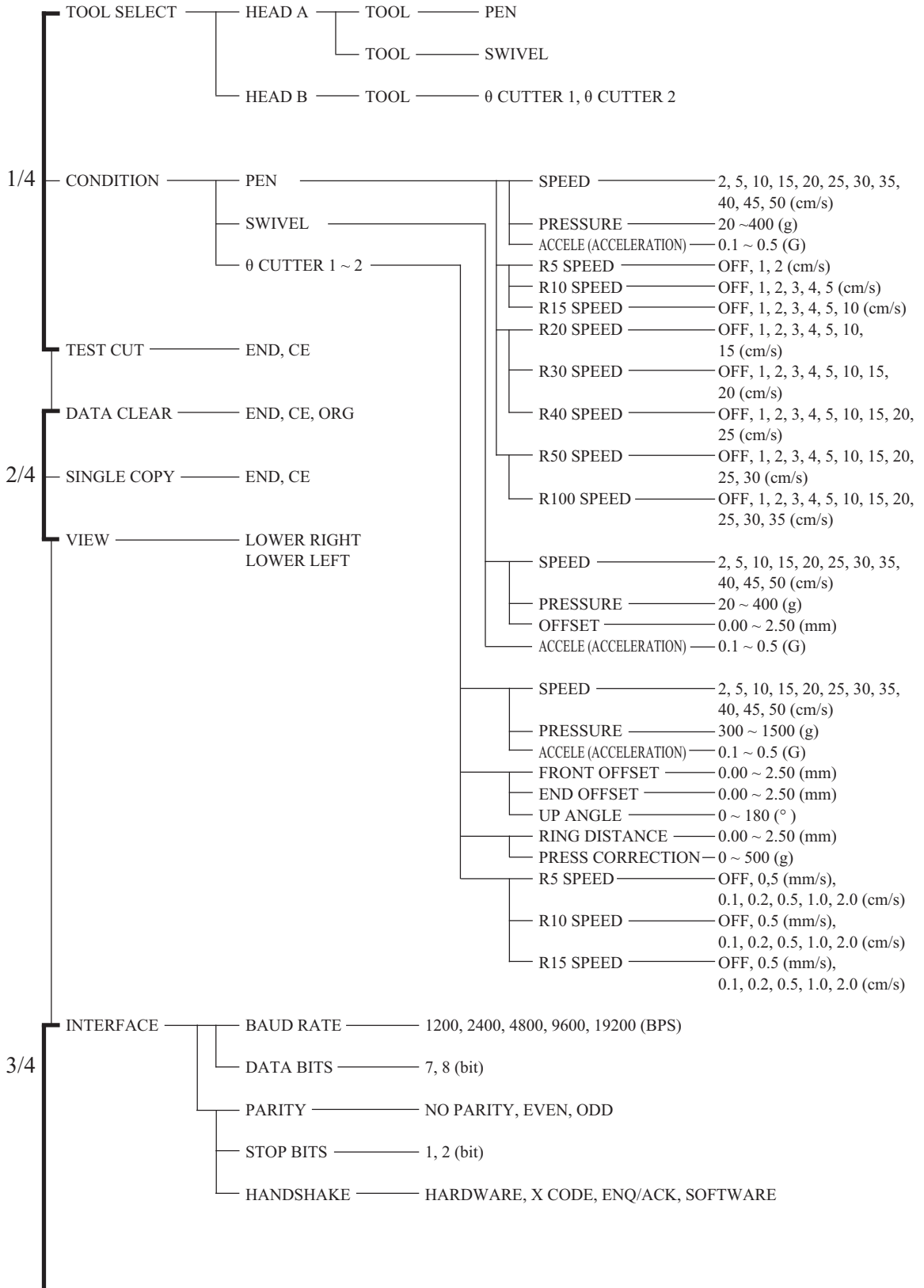

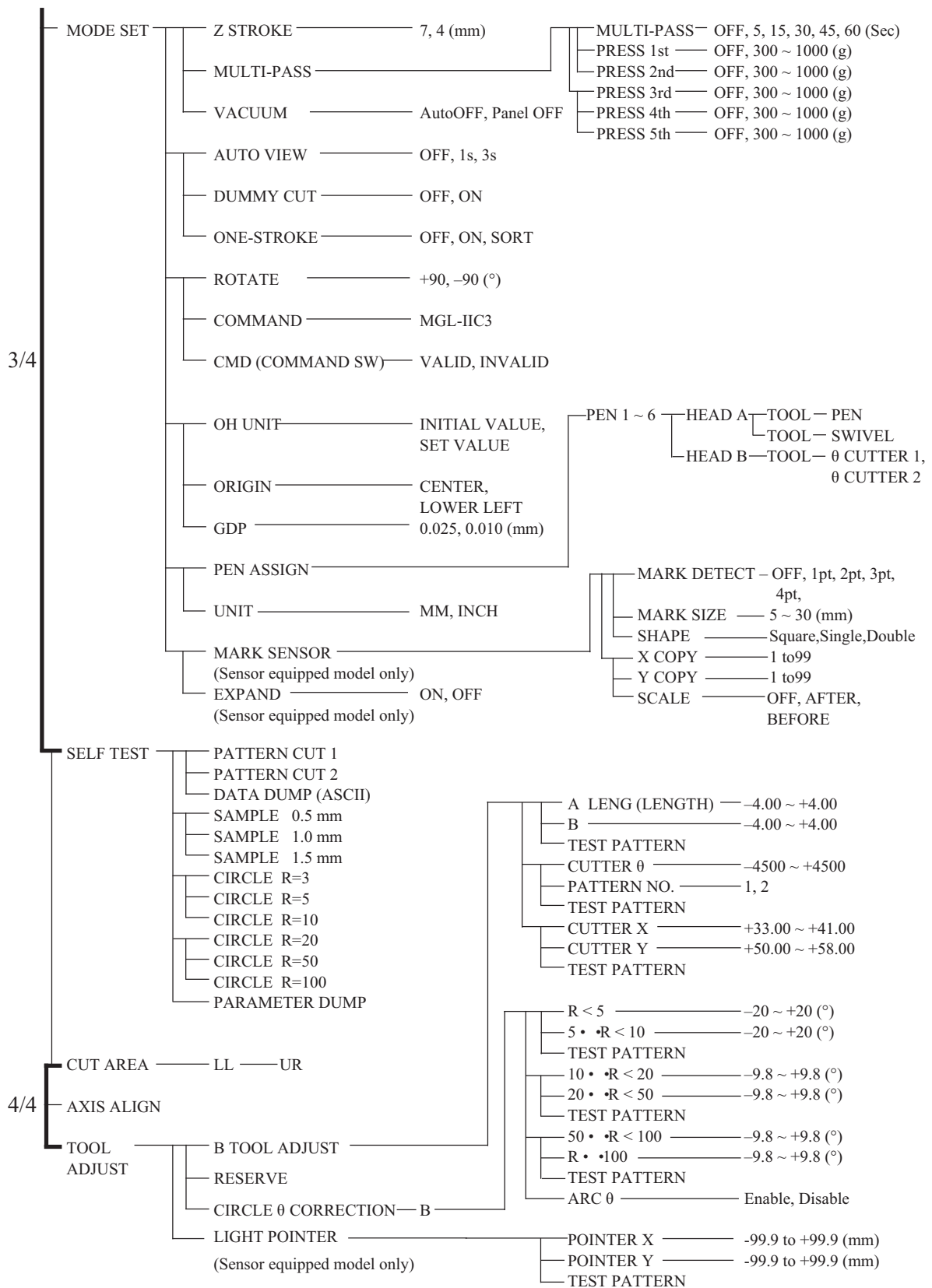

TD/TF-head model

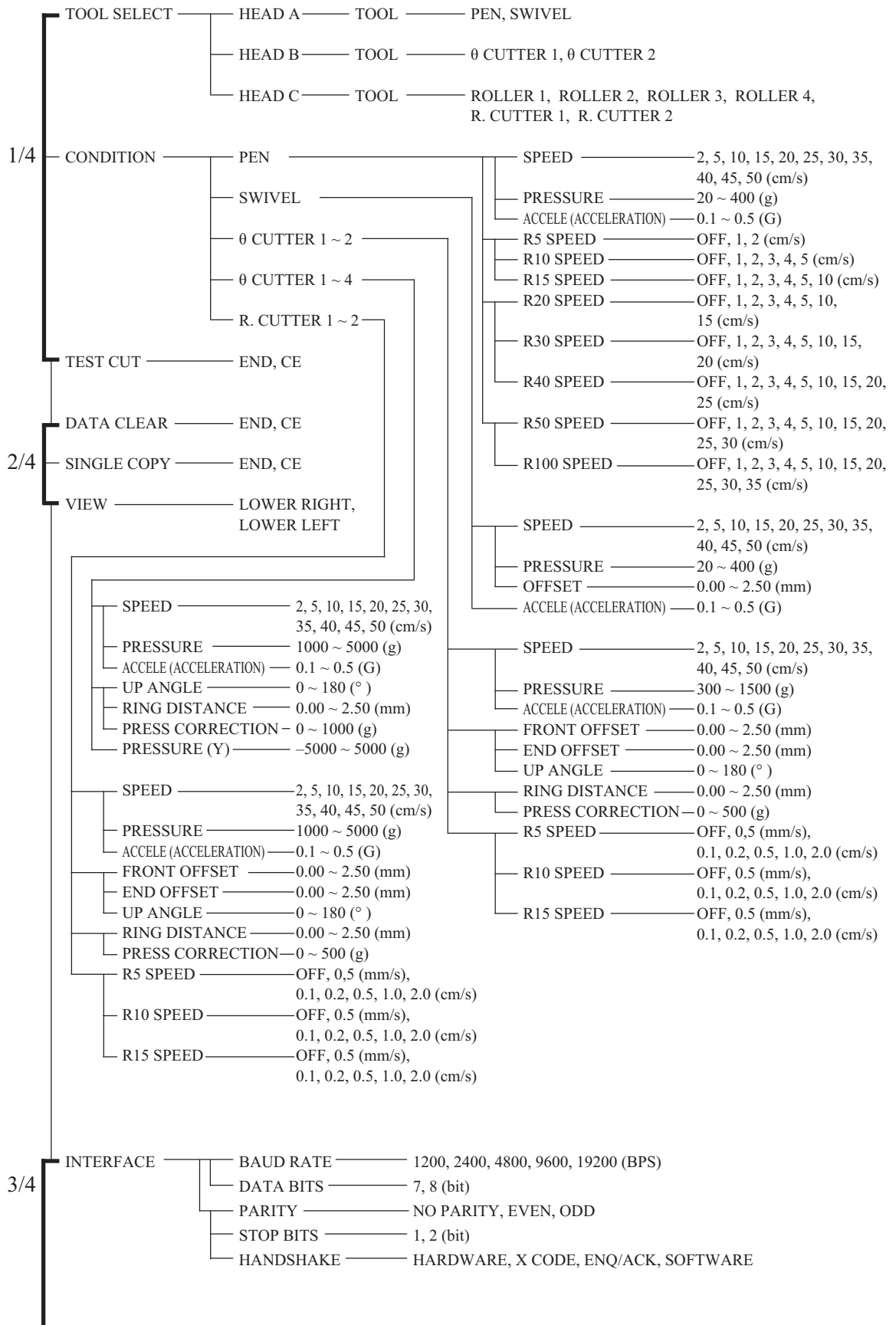

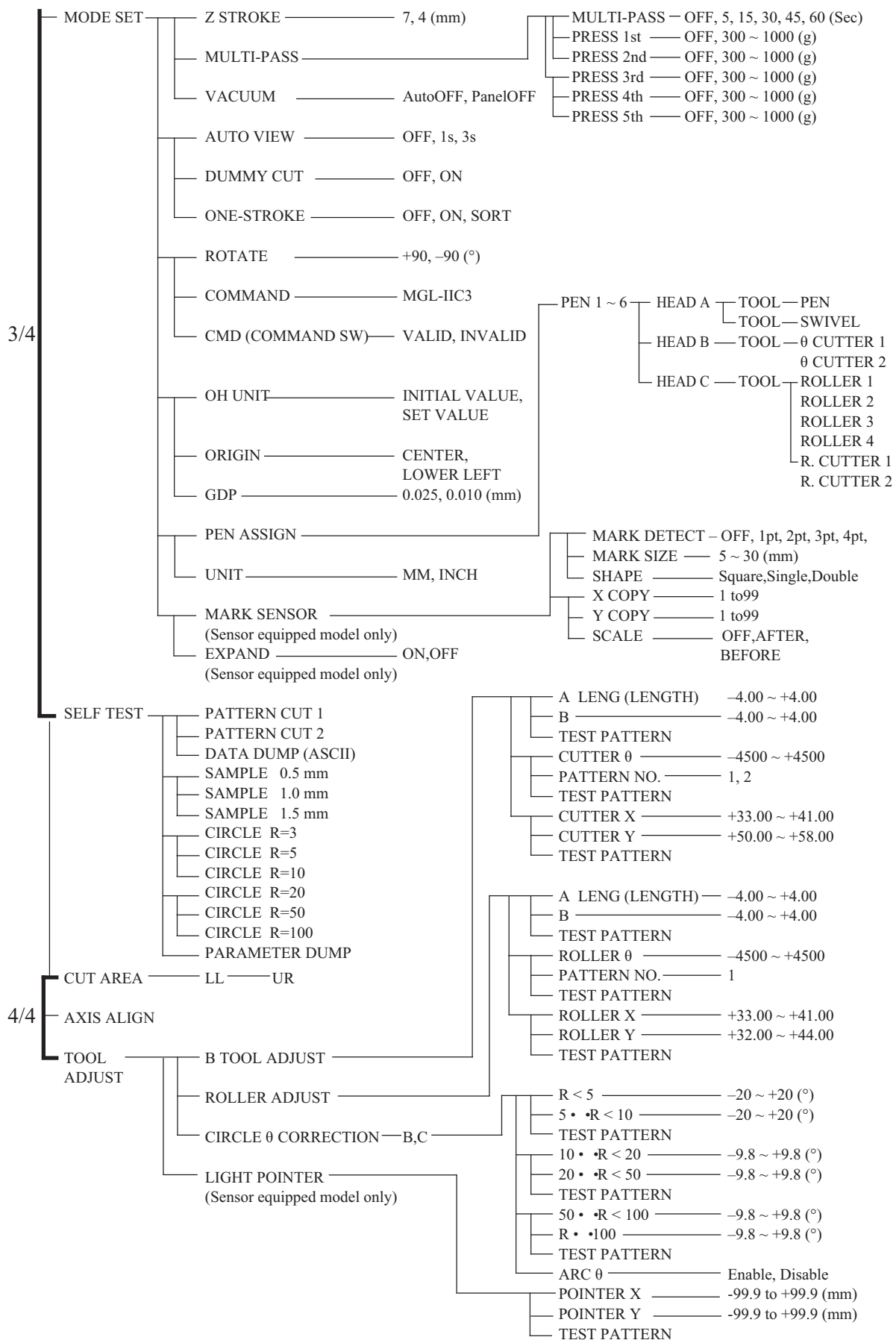

C. OUTPUT SAMPLES

Cutting quality 1

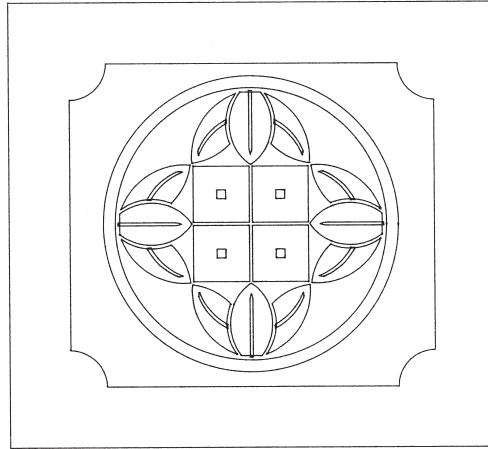

Cutting quality 2

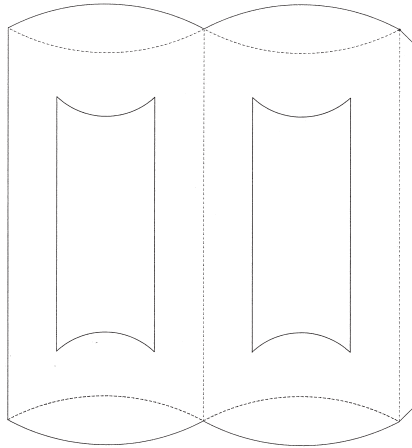

ASCII dump list

```
<<データシート>>
シート=3500
データ=8
リビジョン
シート=1
ハドウェア=1-1 ウェブ

OH: cccaIP 0 0 28000 36000 ; cccaSCO. 56000 0, 72000 ; cccaSP1: cccaPUPA 1400 1000 ; cccaPD: AR-400 0, +360;
cccaPUPA 2400 1000 ; cccaPU AR-360 0, +360; cccaPUPA 3400 1000 ; cccaPD: AR-320 0, +360; cccaPUPA 4400 1000
cccaPD: AR-280 0, +360; cccaPUPA 5400 1000 ; cccaPD: AR-240 0, +360; cccaPUPA 6400 1000 ; cccaPD: AR-200 0, +360
; cccaPUPA 1400 2000 ; cccaPD: AR-400 0, +360; cccaPUPA 2400 2000 ; cccaPD: AR-360 0, +360; cccaPUPA 3400 2000
; cccaPD: AR-320 0, +360; cccaPUPA 4400 2000 ; cccaPD: AR-280 0, +360; cccaPUPA 5400 2000 ; cccaPD: AR-240 0, +36
0; cccaPUPA 6400 2000 ; cccaPD: AR-200 0, +360; cccaPUPA0, 0; cccaPRPD 7000 0 ; cccaPRPD 0 3000 ; cccaPRPD-7000
0 ; cccaPRPD 0 -3000 ; cccaPU0, 0; ccca
```

Sample (coated)

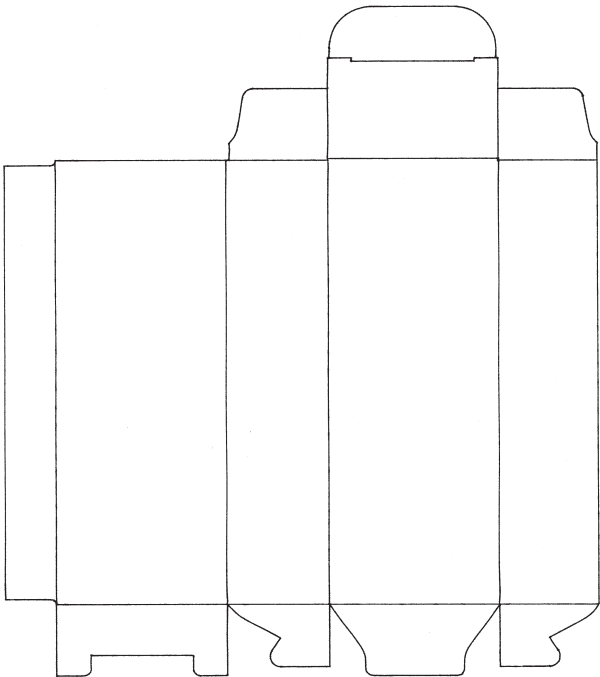

Sample (E corrugated)

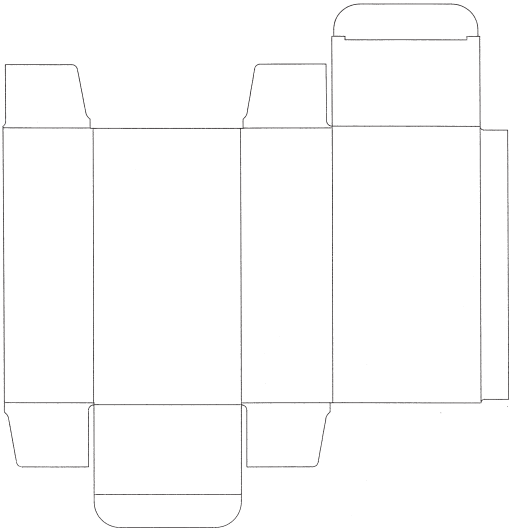

Sample (B corrugated)

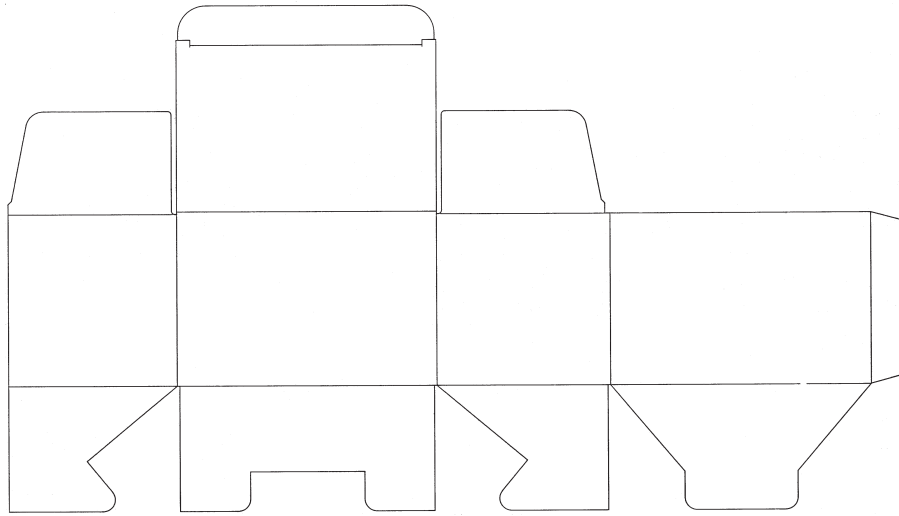

Circle cutting R = 3/5/10/20/50/100

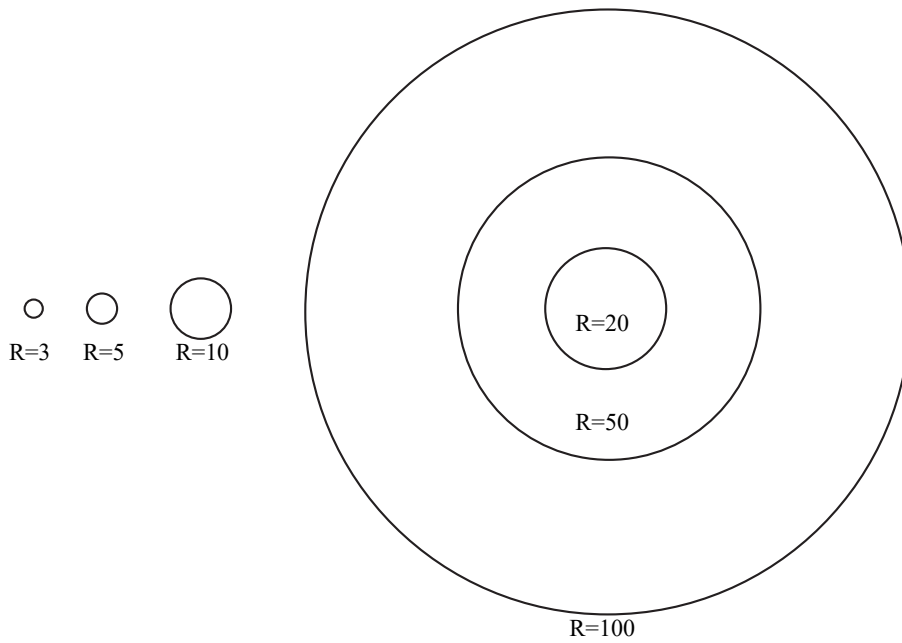

Parameter dump list

```

<PARAMETER DUMP>
[MODEL] [VERSION] [SYSTEM PARAMETER]
0F2/DC-9907-S FW. 1.20 No CONTENTS ADJUST DEFAULT No CONTENTS ADJUST DEFAULT
MV. 1.00 00 PEN PRESS 400 400 39 SENS OFS X 2 0
SV. 1.02 01 S CURVE TIME 350 350 38 SENS OFS Y -8 0
02 ACCELE 25 25 34 PointerOFS X 15 0
03 B ARC CORRECT 1 0 35 PointerOFS Y -15 0
04 C ARC CORRECT 0 0 36 R_LANDING 200 200
05 RADIUS OFS X 40 40 37 SAFETY SENS 1 1
06 RADIUS OFS Y 50 50 38 X-Y UP VEL 5000 5000
07 VELOCITY ANGLE 0 0 39 SERVO GAIN 0 0
08 RESERVE 0 0 40 ASC UP ANGLE 0 0
09 RESERVE 0 0 41 SCALE SET 0 0
10 RESERVE 0 0 42 POWER ON 0 0
11 SKIVEL PRESS 0 0 43 ORIGIN 0 0
12 B LANDING 240 240 44 STROKE COUNT 800 800
13 B PRESS 300 45 38 45 STROKE EQU 45 45
14 B PRESS 1500 80 80 46 R_WAIT TIME 0 1
15 C LANDING 270 270 47 RESERVE 0 0
16 C PRESS 1000 60 60 48 RESERVE 0 0
17 C PRESS 5000 194 0 49 X SEAR RATIO 0 0
18 B PRS OFFSET 0 0 50 MECA OPS X 1 0
19 C PRS OFFSET 0 0 51 MECA OPS Y -1 0
20 ARC DIV LENS 0 0 52 MAX AREA X 870 870
21 TOOL ADJ ADD 1 1 53 MAX AREA Y 900 900
22 B OFFSET X 11872 9500 54 DIST COMP KU 128 0
23 B OFFSET Y 16788 17280 55 DIST COMP Kx 128 0
24 C OFFSET X 11775 11840 56 DIST COMP Y 16 0
25 C OFFSET Y 11855 11900 57 AUTO CLEAR 0 0
26 B T ORIGIN 500 0 58 HASH PASS 0 0
27 C T ORIGIN 350 0 59 MAINTENANCE 1 0
28 B CENTER X -48 0 60 LCD SWITCH 0 1
29 B CENTER Y -52 0 61 SYSTEM 5 1
30 C CENTER X -388 0 62 MODEL TYPE 4 4
31 C CENTER Y 0 0 63 INITIAL 0 0

[CONDITION]
A (PEN) A (SKIVEL) B (CUTTER) C (CUTTER)
SPEED : 5000 5000 5000 5000
PRESSURE : 60 120 300 300
ACCELE : 50 50 50 50
F.OFFSET : 0 0 160 160
E.OFFSET : 0 0 150 150
UP ANGLE : 0 0 300 300
HINS DIS : 0 0 95 95
PRESS OCR : 0 0 0 0
PRESS CCR (Y) : 0 0 0 0
OFFSET : 0 98 0 0
RS SPD : 0 0 0 0
R10 SPD : 0 0 0 0
R15 SPD : 0 0 0 0
R20 SPD : 0 0 0 0
R30 SPD : 0 0 0 0
R40 SPD : 0 0 0 0
R50 SPD : 0 0 0 0
R100 SPD : 0 0 0 0

[INTERFACE] [MULTI PASS] [PEN ASSIGN]
BAUDRATE : 9600 CUT START 0 PEN1: 2 1
DATA BIT : 8 PRESS 1st: 0 PEN2: 3 1
PARITY : NONE PRESS 2nd: 0 PEN3: 2 1
STOP BIT : 1 PRESS 3rd: 0 PEN4: 3 1
HANDSHAKE : HARDWIRE PRESS 4th: 0 PEN5: 1 3
PRESS 5th: 0 PEN6: 1 4

[MODE SET] [CIRCLE CORRECT] [PEN PRESS OFFSET] [MARK SENSOR SET]
Z STRIKE : 7mm R<5 : 0 0 0.0mm: 2022 DETECT : 1PT
AUTOVIEW : OFF 5<R<10 : 0 0 0.8mm: 2040 SIZE : 10mm
DUMMY CUT : OFF 10<R<20 : 0 0 1.0mm: 2075 STYLE : CIRCLE
ONE STRIKE : OFF 20<R<50 : 0 0 2.0mm: 2116 X COPY : 1
ROTATE : +90 50<R<100 : 0 0 3.0mm: 2137 Y COPY : 1
CMD SW : ENABLE R>100 : 0 0 4.0mm: 2181 SCALE : OFF
CH UNIT : INITIAL [COMMAND] 4.8mm: 2204
ORIGIN : CENTER 5.0mm: 2221
SDP : 0.005mm 5.4mm: 2239
Z SIGN : P (+) COMMAND: MGL-IIC3 7.0mm: 2255
UNIT : mm 8.0mm: 2316
VADJUP : Auto OFF 8.8mm: 2380
EXPAND : OFF
  
```

D. SPECIFICATIONS

Basic specifications

Type			CF2-0912	CF2-1215	CF2-1218	
Effective cutting/ plotting area	X	Sensor model	1170mm	1470mm	1770mm	
		No sensor model	1200mm	1500mm	1800mm	
	Y		900mm	1200mm		
Maximum size of work that can be placed on the device	X		1445mm	1745mm	2045mm	
	Y		1200mm	1500mm		
Driving method	By 4-axis (X, Y, Z, θ) DC software servo					
Max. speed	50 cm/s (20 ips)					
Max. acceleration	0.5G					
Mechanical resolution	X,Y		X-axis: 0.00234mm, Y-axis: 0.003125 mm			
	θ		0.05625°(1/17,18°)			
Command resolution	0.025 mm/0.01 mm (changed over on the operation panel)					
Repeatability	±0.1mm					
Range accuracy	Whichever the larger one either ±0.1 mm or ±0.1% of the traveling distance					
Origin reproducibility	0.1 mm					
Specifications for head	Pen		Ceramic pen, oil ball-point pen and water ball-point pen			
	Cutter		Tangential cutter, swivel blade and creasing roller			
	Max. pressure, number of responses	Pen (pen/swivel blade)		400 g 20/sec		
		T (low-pressure tangential 1500 g 8/sec cutter)		1500 g 8/sec		
		F (high-pressure tangential cutter)		5000 g 8/sec		
		D (crease roller)		5000 g 8/sec		
Height adjusting range		0 ~ 25 mm (0 ~ 1")				
Max. thickness of work that can be placed on the device	25 mm (1")					
Work securing method	Vacuum suction by blower					
Receiving buffer capacity	1MB					
Command	MGL-IIc 3 (Support MGL-IIc)					
Interface	RS-232C					
Outside dimension	Width		1757mm	2057mm	2357mm	
	Depth		1595mm	1895mm		
	Height about		about 1100mm			
	Cut surface height		about 770mm			
	Weight		140kg	165kg	180kg	
Noize level	Maximum 71dB					
Operating environment	5 to 40°C 35 to 75% (Rh) With no dew condensation					
Power supply capacity	50/60 Hz AC100/120/200/240 V(tap changing)					
Power consumption	Main unit: Less than 500VA Blower: Stated separately					

Specifications for interface specifications

Basic specifications

Item	Specifications
Signal level standard	Conforms to EIA RS232C
Synchronous system	Asynchronous system
Communication system	Full-duplex
Logical requirements	EIA RS-232C, CCITT V.24, JIS x 5101
Electric properties	EIA RS-232C, CCITT V.24, JIS x 5101
Connector	D-SUB25 pin (female) conforming to JIS X 5101
Transmission speed (bps)	1200/2400/4800/9600/19200
Start bit length	1
Stop bit length	1/1.5/2
Parity bit	No parity / even number / odd number
Hand shake	Hard / X code

Configuration of the connector and signal table

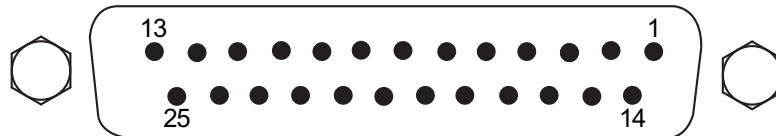

Pin No.	Abbreviation	Name of signal	Source of transmission
1	FG	Protective ground	
2	SD	Transmitted data	This device
3	RD	Received data	Computer
4	RS	Request for transmission	This device
5	CS	Transmission possible	Computer
6	DR	Data set ready	Computer
7	SG	Signal ground	—
20	ER	Data terminal ready	This device

E. MAINTENANCE

To use the device comfortably for an extended period of time, it is recommended to perform periodical cleaning.

- Use neither detergent containing abrasives nor thinner. Such materials can deform the cover and the cutting panel.

Cutting panel surface

If any of the suction holes on the cutting panel is clogged, be sure to insert a thin wire into the clogged hole. The substance clogged in the hole will be discharged from the exhaust port of the blower.

If the cutting panel surface is slightly stained, clear stains with a piece of clean and dry cloth. If the cutting panel surface is heavily stained, impregnate a piece of clean and dry cloth with a little amount of alcohol and wipe the stained surface.

Cover

If the cover is slightly stained, clear stains with a piece of clean and dry cloth. If the cover is heavily stained, impregnate a piece of clean and dry cloth with a little amount of alcohol and wipe the stained surface.

Filter unit

The media inside the filter unit is removable, and needs to be cleaned at a regular intervals.

1. **Remove the filter unit by holding both sides.**



2. **Separate the filter cover and the media.**



-
3. Vacuum the dust from the media.



4. Put the media back in place.

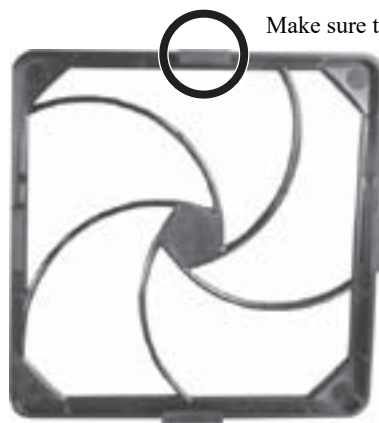

Make sure the shorter projection comes at the top.

F. OPTIONAL ACCESSORIES

Swivel cutter components

Name of product	Product No.	Specifications	Remarks
Swivel cutter holder	SPA-0001	One piece of holder without blade	
Swivel blade for vinyl sheet	SPB-0001	Package of three pieces of blades	Common blade for swivel cutter
Swivel blade for small letters	SPB-0003	Package of three pieces of blades	
Swivel blade for rubber sheet	SPB-0005	Package of three pieces of blades	
Swivel blade for reflecting sheet	SPB-0006	Package of three pieces of blades	
Swivel blade for fluorescent sheet	SPB-0007	Package of three pieces of blades	
Blade tip adjuster	OPT-C0066	Dial type	

Tangential cutter components

Name of product	Product No.	Specifications	Remarks
Cutter holder, 4N model	SPA-0053	For works of which thickness is 5 mm or less, with one piece of blade	
Cutter holder, 7N model	SPA-0054	For works of which thickness is 7 mm or less, with one piece of blade	
Cutter holder, RN model	SPA-0055	For reflecting sheet, with one piece of blade	
Cutter holder, JN model	SPA-0061	For joint sheet, with one piece of blade	
Cutter holder, 10N model	SPA-0077	For joint sheet, with one piece of blade	
Tangential cutter blade	SPB-0008	For works of which thickness is 2 mm or less, with one piece of blade	Adaptable to SPA-0053 holder
	SPB-0009	For reflecting sheet, with one piece of blade	Adaptable to SPA-0055 holder
	SPB-0031	For joint sheet, with two pieces of blades	Adaptable to SPA-0061 holder
	SPB-0043	For works of which thickness is 5 mm or less, 5 cases of 40 pieces of blades each	Adaptable to SPA-0053 holder
	SPB-0044	For works of which thickness is 5 mm or less, 5 cases of 40 pieces of blades each	
	SPB-0045	For works of which thickness is 5 mm or less, 3 cases of one piece of blades each	
	SPB-0046	For works of which thickness is 2 mm or less, 3 cases of one piece of blades each	
	SPB-0047	For works of which thickness is 5 mm or less, with one piece of blade	
	SPB-0048	For works of which thickness is 7 mm or less, 5 cases of 15 pieces of blades each	Adaptable to SPA-0054 holder
SPB-0051	For works of which thickness is 7 mm or less, one cases of 3 pieces of blades each	Adaptable to SPA-0077 holder	
Blade tip adjuster	OPT-C0030	Dial type	Adaptable to SPA-0053 holder

Creasing roller components

Name of product	Product No.	Specifications	Remarks
Creasing roller, DN model	SPA-0056	For corrugated fiberboard (E corrugated fiberboard)	For TD-head
Creasing roller, CN model	SPA-0057	For coated board	For TD-head
Creasing roller, PN model	SPA-0058	For pleated works	TD-head
Crease plate EN	SPA-0067	For corrugated fiberboard (E corrugated fiberboard)	For TD-head

Pen components

Name of product	Product No.	Specifications	Remarks
Water ball-point pen	BK-70	Pentel	
Oil ball-point pen	K105-A	Pentel	
	K105-GA	Pentel	

Optional products

Name of product	Product No.	Specifications
Interface cable for PC (5 m)	RSC-02-05	For 25PIN on PC-98 Series
Interface cable for DOS/V (3 m)	RSC-32-05	For 9PIN on DOS/V personal computers (9PIN male type and 25PIN female type)
Interface cable for Macintosh (3 m)	OPT-SS019	For Macintosh (9PIN male type and 25PIN female type)
Caster unit	OPT-C0111	Factory option, 4 units
Vacuum unit	OPT-C0192	120V, 0.51/0.7kw, filter separately available (OPT-C0165)
Vacuum unit	OPT-C0130	220V, 0.51/0.7kw, filter separately available (OPT-C0165)
Vacuum unit	OPT-C0131	240V, 0.51/0.7kw, filter separately available (OPT-C0165)
Vacuum unit	OPT-C0193	120V, 0.51kw, filter separately available (OPT-C0164)
Vacuum unit	OPT-C0194	220V, 0.25/0.38kw, filter separately available (OPT-C0164)
Vacuum unit	OPT-C0195	240V, 0.25/0.38kw, filter separately available (OPT-C0164)

Mimaki

D201373-17-19052023

Printed in Japan

© 2008 MIMAKI ENGINEERING Co., Ltd. All rights reserved.

KM