

Operation Manual

UV INKJET PRINTER **JFX600-2531**

Operation Manual

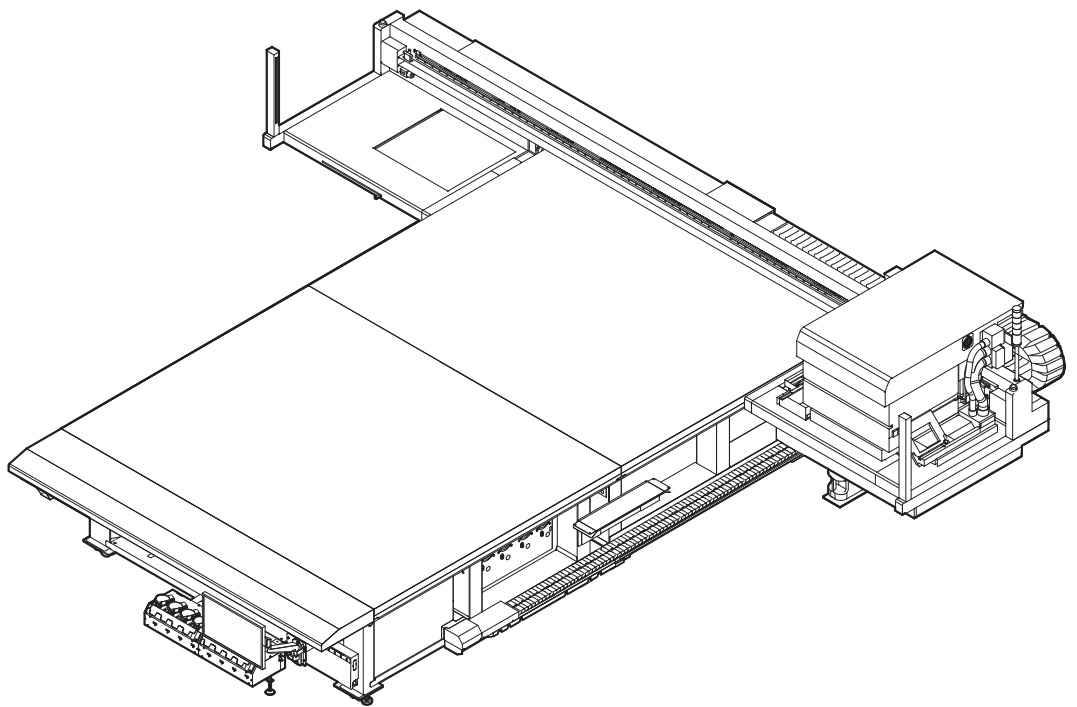

You can also download the latest manual from official website.

MIMAKI ENGINEERING CO., LTD.

<https://mimaki.com/>

D203830-11
Original instructions

TABLE OF CONTENTS

| | |
|--|----|
| Introduction | 5 |
| To Ensure Safe Use | 7 |
| Symbols | 7 |
| Usage Precautions | 8 |
| Usage Restrictions | 13 |
| Hazardous and Prohibited Actions | 14 |
| Connecting the Power | 17 |
| Wiring method | 17 |
| Notes on Handling Ink or Any Other Liquid Used with the Machine | 20 |
| Ink Specifications | 21 |
| Restrictions Concerning the Expiration Date of Ink Used in the Machine | 22 |
| Installation Precautions | 23 |
| Installation Space | 24 |
| Adjuster Feet | 25 |
| When Relocating This Machine | 25 |
| Warning Labels | 26 |

Chapter 1 Before Use

| | |
|---|----|
| 1.1 Part Names and Functions | 30 |
| Carriage | 32 |
| Capping station | 32 |
| Ink Status Lamp | 32 |
| Signal tower light | 33 |
| Light Curtain | 34 |
| 1.2 System Configuration | 35 |
| Connecting to a Local Network | 36 |
| 1.3 Preparing the RIP PC | 38 |
| Setting up an Ethernet connection | 38 |
| Installing the Mimaki Driver | 41 |
| Installing RIP Software | 42 |
| Obtaining Color Profiles | 42 |
| Setting Up RIP Software | 42 |
| 1.4 Ink Replacement Method | 44 |
| When Ink Near End is Displayed | 44 |
| When Ink End is Displayed | 44 |
| Replacing Ink | 45 |

Chapter 2 Printing

| | |
|---|----|
| 2.1 Print Process | 52 |
| 2.2 Using the toggle print function | 55 |
| Setting the toggle print mode | 56 |
| Setting the default print area | 57 |

| | |
|--|----|
| 2.3 Loading the Media | 59 |
| Media | 59 |
| Load the media. | 60 |
| Setting the Media Origin | 65 |
| 2.4 Registering the Media Thickness..... | 70 |
| Measuring Automatically..... | 70 |
| Entering Values Manually | 71 |
| 2.5 Setting the Head Gap | 73 |
| Checking the Head Gap Value | 73 |
| 2.6 Test Printing..... | 74 |
| Checking Print Head Discharge..... | 74 |
| Checking White Ink Discharge..... | 75 |
| Ejection Failures | 77 |
| 2.7 Head Cleaning | 78 |
| 2.8 Correcting the Dot Position..... | 80 |
| 2.9 Feed Correction | 81 |
| 2.10 Preparing a Job (RIP Data) | 83 |
| With output port set to [Ethernet] | 83 |
| With output port set to [File]..... | 87 |
| 2.11 Printing..... | 90 |
| Repositioning the UV-LED Unit | 90 |
| UV-LED Assistance Scan | 91 |
| Starting Printing | 92 |
| Stopping Printing | 97 |
| Moving the Y-Bar | 97 |
| Printing Using Nozzle Recovery | 98 |

Chapter 3 Settings (MPC)

| | |
|--|-----|
| 3.1 Mimaki Printer Controller | 106 |
| Screen structure | 106 |
| Checking the default values..... | 109 |
| 3.2 Print menu | 110 |
| 3.3 Maintenance Menu | 111 |
| Nozzle Check Before Print..... | 113 |
| Regist nozzle recovery | 113 |
| 3.4 Setting 1 Menu..... | 117 |
| Setting UV illuminance presets and default | 119 |
| 3.5 Setting 2 Menu..... | 122 |
| 3.6 History Menu..... | 123 |
| 3.7 System menu..... | 124 |
| Power Supply..... | 124 |

Chapter 4 Maintenance

| | |
|-----------------------------------|-----|
| 4.1 Maintenance Precautions | 128 |
|-----------------------------------|-----|

| | |
|--|-----|
| 4.2 Maintenance Timing | 129 |
| Items Required for Maintenance..... | 129 |
| 4.3 Performing Maintenance..... | 130 |
| Ink Maintenance | 130 |
| Wiper Cleaning | 130 |
| Cap Rubber Cleaning | 132 |
| Station Area Cleaning..... | 132 |
| NCU Cleaning..... | 133 |
| Carriage Underside Cleaning | 134 |
| Waste Ink Draining Channel Cleaning..... | 136 |
| Table Cleaning..... | 137 |
| Exterior Cleaning (e.g., cover, Y-bar,) | 137 |
| Periodic Lubrication of the LM Blocks..... | 138 |
| 4.4 Consumable Item Replacement | 145 |
| Wiper Replacement | 145 |
| Carriage Filter Replacement..... | 146 |
| Flushing Filter Replacement..... | 147 |
| NCU Ink Pad Replacement..... | 147 |
| Bottle Ink Wipe Filter Replacement | 148 |
| Waste Ink Tank Replacement..... | 149 |
| Refilling Cooling Water (Mixed With Antifreeze)..... | 150 |
| Bottle Cap Replacement..... | 152 |

Chapter 5 Troubleshooting

| | |
|---|-----|
| 5.1 Troubleshooting | 154 |
| The power does not turn on..... | 154 |
| Printing is not possible..... | 154 |
| The media jams or the media is dirty..... | 154 |
| Image defects occur..... | 154 |
| A pressure error occurred..... | 158 |
| The ink has leaked..... | 159 |
| The light-blocking cover comes off..... | 159 |
| Touch panel operation is not possible..... | 160 |
| Nozzle clogging occurs frequently when clear ink is used..... | 160 |
| 5.2 Problems Causing Messages to Appear | 161 |
| 5.3 Collecting Logs | 174 |

Chapter 6 Appendix

| | |
|---------------------------|-----|
| 6.1 Specifications..... | 178 |
| 6.2 LICENSE Library | 180 |

Introduction

Thank you for purchasing the UV-LED curable inkjet printer JFX600-2531.

Read this operating manual ("this document" hereinafter) thoroughly and make sure you understand its contents to ensure safe and correct use of the product.

Please note that the illustrations contained in this manual are intended to show functions, procedures, or operations and may sometimes differ slightly from the actual machine.

Adobe, the Adobe logo, Acrobat, Illustrator, Photoshop, and PostScript are the trademarks or registered trademarks of Adobe Incorporated in the United States and other countries.

RasterLink is a trademark or a registered trademark of Mimaki Engineering Co. Ltd. in Japan and other countries.

Other company and product names mentioned herein are the trademarks or registered trademarks of the respective companies in Japan and in other countries.

Unauthorized reproduction of any portion of this document is strictly prohibited.

© 2024 MIMAKI ENGINEERING Co., Ltd.

● DISCLAIMERS

- MIMAKI ENGINEERING REJECTS ALL LIABILITY FOR DAMAGE ARISING DIRECTLY OR INDIRECTLY FROM THE USE OF THE JFX600-2531 ("THIS MACHINE" HEREINAFTER), WHETHER OR NOT THE PRODUCT IS FAULTY.
- MIMAKI ENGINEERING REJECTS ALL LIABILITY FOR DAMAGE, DIRECT OR INDIRECT, TO MATERIALS CREATED WHILE USING THIS MACHINE.
- USING THIS MACHINE IN CONJUNCTION WITH DEVICES OTHER THAN THOSE RECOMMENDED BY MIMAKI ENGINEERING MAY RESULT IN FIRE OR ACCIDENTS. SUCH INCIDENTS ARE NOT COVERED BY THE PRODUCT WARRANTY. MIMAKI ENGINEERING REJECTS ALL LIABILITY FOR DAMAGE, DIRECT OR INDIRECT, ARISING FROM SUCH INCIDENTS.
- USE ONLY GENUINE MIMAKI ENGINEERING INK AND MAINTENANCE LIQUID. USE OF OTHER PRODUCTS MAY RESULT IN FAILURES OR REDUCE PRINT QUALITY. SUCH INCIDENTS ARE NOT COVERED BY THE PRODUCT WARRANTY. MIMAKI ENGINEERING REJECTS ALL LIABILITY FOR DAMAGE, DIRECT OR INDIRECT, ARISING FROM SUCH INCIDENTS.
- DO NOT ATTEMPT TO REFILL THE INK BOTTLES WITH UNAUTHORIZED INK. SUCH INCIDENTS ARE NOT COVERED BY THE PRODUCT WARRANTY. MIMAKI ENGINEERING REJECTS ALL LIABILITY FOR DAMAGE, DIRECT OR INDIRECT, ARISING FROM SUCH INCIDENTS.
- USE ONLY GENUINE MIMAKI ENGINEERING ANTI FREEZING LIQUID. USE OF OTHER ANTI FREEZING LIQUID MAY CAUSE FAILURES OR REDUCE PRINT QUALITY. SUCH INCIDENTS ARE NOT COVERED BY THE PRODUCT WARRANTY. MIMAKI ENGINEERING REJECTS ALL LIABILITY FOR DAMAGE, DIRECT OR INDIRECT, ARISING FROM SUCH INCIDENTS.
- AVOID USING UV-LED UNITS OR UV POWER SUPPLY UNITS OTHER THAN THOSE SPECIFIED BY MIMAKI ENGINEERING. USING DEVICES OTHER THAN GENUINE MIMAKI ENGINEERING DEVICES MAY RESULT IN FAILURE, ELECTRIC SHOCK, OR FIRE. SUCH INCIDENTS ARE NOT COVERED BY THE PRODUCT WARRANTY. MIMAKI ENGINEERING REJECTS ALL LIABILITY FOR DAMAGE, DIRECT OR INDIRECT, ARISING FROM SUCH INCIDENTS.

● TV and radio interference



- The machine emits high-frequency electromagnetic radiation while operating. Under certain circumstances, this may result in TV or radio interference. We make no guarantee that this machine will not affect special radio or TV equipment.

If radio or TV interference occurs, check the radio or TV reception after turning off the machine. If the interference disappears when the power is turned off, the machine is likely to be the cause of the interference.

Try any of the following solutions or combinations of these solutions:









- Change the orientation of the TV or radio antenna to find a position where interference does not occur.

- Move the TV or radio away from this machine.

To Ensure Safe Use

Symbols

In this document, symbols are used to indicate various precautions for operation. Make sure you fully understand the meaning of each symbol to ensure you use the machine safely and correctly.

| Explanation | | |
|---|-----------------------|--|
|  | Warning | Indicates a potential hazard that may result in death or serious injury if handled improperly or if instructions are disregarded. |
|  | Caution | Indicates a potential hazard that may result in minor or moderate injury if handled improperly or if instructions are disregarded. |
|  | Notice | Indicates a potential hazard that may result in property damage if handled improperly or if instructions are disregarded. |
|  | Warning sign | Indicates something that requires attention. Warning specifics are drawn inside the symbol. |
|  | Mandatory action sign | Indicates an action that must be carried out. The specifics of the mandatory action are drawn inside the symbol. |
|  | Prohibition sign | Indicates a prohibited action. The specifics of the prohibited action are drawn inside the symbol. |
|  | Important | Indicates important information related to use of this machine. |
|  | Tip | Indicates useful reference information. |
|  | Reference information | Indicates the corresponding page for related information. |

Usage Precautions

● In the event of abnormal conditions

WARNING



- In the event of abnormal conditions such as smoke or unusual odor, turn off the main power immediately and turn off the breaker. Continuing to use the machine under these conditions may result in failure, electric shock, or fire. Once you have confirmed that smoke is no longer being emitted, contact your local dealer or our service office. Never attempt to repair the machine yourself, which is hazardous.

CAUTION



- Immediately wipe off any ink, maintenance liquid, waste ink, or other liquid used with the product that comes into contact with your skin. Then wash using soap, and rinse with plenty of water. Failure to wash off ink may result in skin inflammation. If your skin becomes irritated or painful, seek medical attention immediately.
- If ink, maintenance liquid, waste ink, or any other liquid used in the product comes into contact with your eyes, rinse immediately with plenty of clean water. Rinse for at least 15 minutes. If you wear contact lenses and they can be easily removed, remove after rinsing for at least 15 minutes with clean water. Be sure to also rinse the undersides of your eyelids. Failure to rinse off ink may result in blindness or impaired vision. If your eyes become irritated or painful, seek medical attention immediately.
- If ink, maintenance liquid, waste ink, or any other liquid used in the product enters your mouth or is swallowed, gargle with water immediately. Do not induce vomiting. Seek medical attention promptly. Inducing vomiting may cause liquid to enter the airway.
- If a large amount of vapor is inhaled, move to a well-ventilated area, keep warm, and rest in a posture that allows easy breathing. If the condition does not improve, seek medical attention promptly.

NOTICE



- If an ink leak occurs, turn off the three main power supply switches immediately. Then, contact your local dealer or our service office.

● Power supply precautions

⚠ WARNING



- Do not damage or modify the power cable. Do not place heavy objects on, heat or stretch it. Doing so may damage the cable, leading to electric shock or fire.
- Do not use the power cable if it is damaged or broken or if the core wire is exposed. Otherwise there is a risk of failure, electric shock, or fire.
- The machine has a large leakage current with a danger of electric shock. ([PROTECTIVE CONDUCTOR CURRENT] = 13.2 mA)
To prevent electric shock, be sure to connect the ground wire before connecting the live and neutral wires.



- Always connect the machine to a switchboard with grounded polarity. Otherwise there is a risk of failure, electric shock, or fire. All electrical work (Class C grounding work; formerly Type 3 grounding work) must be handled by a licensed electrician.



- Do not turn off the main power supply for the machine and the power supply for the control PC. Turning off the power supply will disable the automatic maintenance function (including nozzle clogging prevention function and ink discharge channel cleaning function). This increases the risk of ejection failures (such as nozzle clogging or deflection).

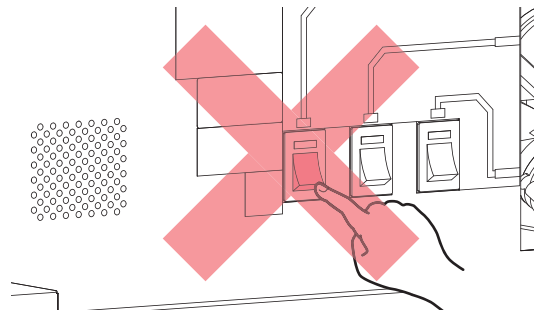

- Use the machine with a power supply that meets specifications.
- When connecting the power cable, check the input voltage of the power outlet and the capacity of the breaker. Also, connect each cable to a separate power source with an independent breaker. Connecting to power outlets linked with the same breaker will cause the breaker to trip.

● Vacuum unit

NOTICE



- Do not attempt to disassemble or repair the vacuum unit. Doing so may reduce the vacuum strength or cause abnormal heat generation or failure of this machine.



- Avoid touching the relief valve (pressure regulating valve) and blocking the exhaust port of the vacuum unit. Doing so may reduce the vacuum strength or cause abnormal heat generation or failure of this machine.



- Use at low temperature may cause the vacuum unit to generate a high-pitched noise. This does not indicate a failure.

● Do not stand or sit on the machine.

NOTICE



- Never stand or sit on the table. Disregarding this precaution may impair the precision of the table surface and affect print quality.

● **Caution regarding moving parts**

 **CAUTION**



- Keep parts of the body such as the face and hands away from moving parts. Also keep clothing (e.g., loose clothing and accessories) that may impede work away from the machine. Failure to do so may result in injury.



- Long hair should be tied back. Failure to do so may result in injury.

● **Do not disassemble or repair**

 **WARNING**



- Do not attempt to disassemble or repair this machine. Otherwise there is a risk of failure, electric shock, or fire.

● **Ultraviolet light (UV) and the UV-LED unit**

 **WARNING**



- Do not place combustibles under the UV-LED unit, and do not cover it with paper or cloth. There is a risk of fire or burns.

- Small amounts of ultraviolet light may leak from the UV-LED unit. Wear UV safety glasses, face shields, masks, gloves, and long-sleeved clothing to protect the eyes and skin from ultraviolet light.

- (1) Exposure to ultraviolet light may result in skin inflammation. Even if no inflammation occurs, extended or repeated exposure may lead to chronic problems.

- Acute problems: Inflammation
- Chronic problems: Skin cancer, wrinkles, blotches

- (2) Looking directly at the lamp while the lamp is on may result in eye pain or damage to eyesight. Even if no eye pain occurs, extended or repeated exposure may lead to chronic problems.

- Acute problems: Ultraviolet keratitis, conjunctivitis, discomfort, pain, watery eyes
- Chronic problems: Pterygium, cataracts



- Be sure to use the UV safety glasses provided. Disregarding this precaution may result in eye pain or damage to eyesight.

 **CAUTION**



- The UV-LED unit becomes extremely hot. Be careful not to touch the LED after it has been turned off until it has sufficiently cooled.



- Do not expose the skin or eyes directly or indirectly to light from the UV-LED unit. The UV-LED unit emits ultraviolet (UV) light. Skin or eye exposure may result in inflammation.

NOTICE



- Avoid scratching or subjecting the UV-LED unit to excessive force. Disregarding this precaution may result in deformation or failure of the unit.
- Avoid touching the glass on the underside of the UV-LED unit with bare hands. Disregarding this precaution may impair UV ink curing. If the glass becomes dirty, wipe clean using a soft, clean cloth soaked with ethanol. Be careful to keep ethanol from splashing on the covers or other parts while cleaning. Disregarding this precaution may result in deformation or failure of the unit.

● About the monitor arm

⚠ CAUTION



- The maximum load capacity of the monitor arm is 8 kg. Do not mount any monitor other than that specified by Mimaki. Doing so may damage the arm.
- The monitor arm on which the touch panel is mounted is attached to the front of the machine. Take care to avoid bumping into the monitor arm or touch panel and injuring yourself while working.

NOTICE



- The monitor arm angle can be adjusted to vary the touch panel mounting angle and orientation. Adjust the arm angle so as not to impede the carriage movement range or printing operations.

● About the touch panel

NOTICE



- Do not press, rub, or push the touch panel with excessive force.
- Do not tap the touch panel with a ball-point pen or other hard metal object.
- Do not touch the black outer frame of the screen.
- Do not affix adhesive tape or labels to the touch panel screen or black outer frame. Doing so may reduce sensitivity and prevent operation.

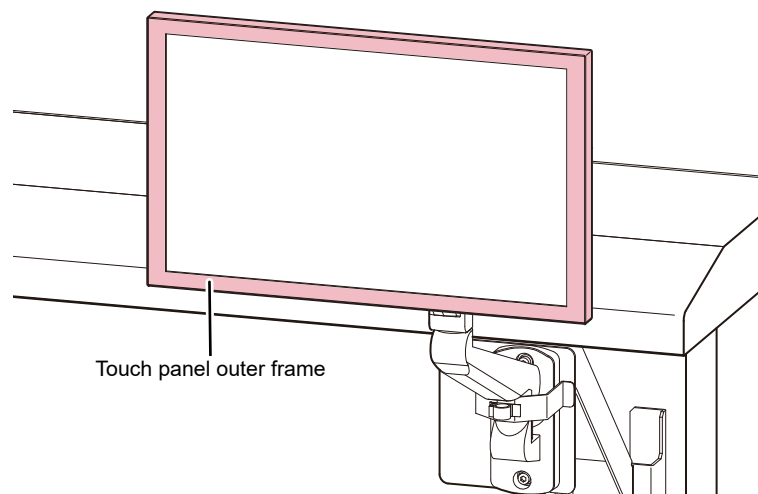

- Immediately wipe off any liquid on the touch panel.
- Take care not to allow any liquids to get inside the touch panel gaps.

● Other usage precautions

⚠ WARNING



- Keep children away from the machine.

NOTICE

● **Disposing of the product**

CAUTION



- Please contact your local retailer or service agent.
 - When disposing of the product yourself, contact an industrial waste disposal operator or dispose of the product in accordance with local laws and regulations.
-

Usage Restrictions

⚠ WARNING



- The machine poses significant safety hazards due to the high-speed movement of the carriage from side to side, Y-bar movements, sections with high temperatures and hazardous voltages, and the UV-LED. Use of the machine is restricted to operators with a thorough understanding of the hazards involved.



- Physically isolate the machine, such as enclosing it in a special room or area surrounded by safety fences. Take appropriate steps to clearly indicate that this is a hazardous area.
 - Any special room provided should incorporate a door that can be locked or has a safety interlock.
 - Any safety fences used must conform to the EN ISO 13857 standards.



- Be sure to prohibit entry to restricted areas for all people except personnel who have undergone our risk assessment training or persons trained by them.

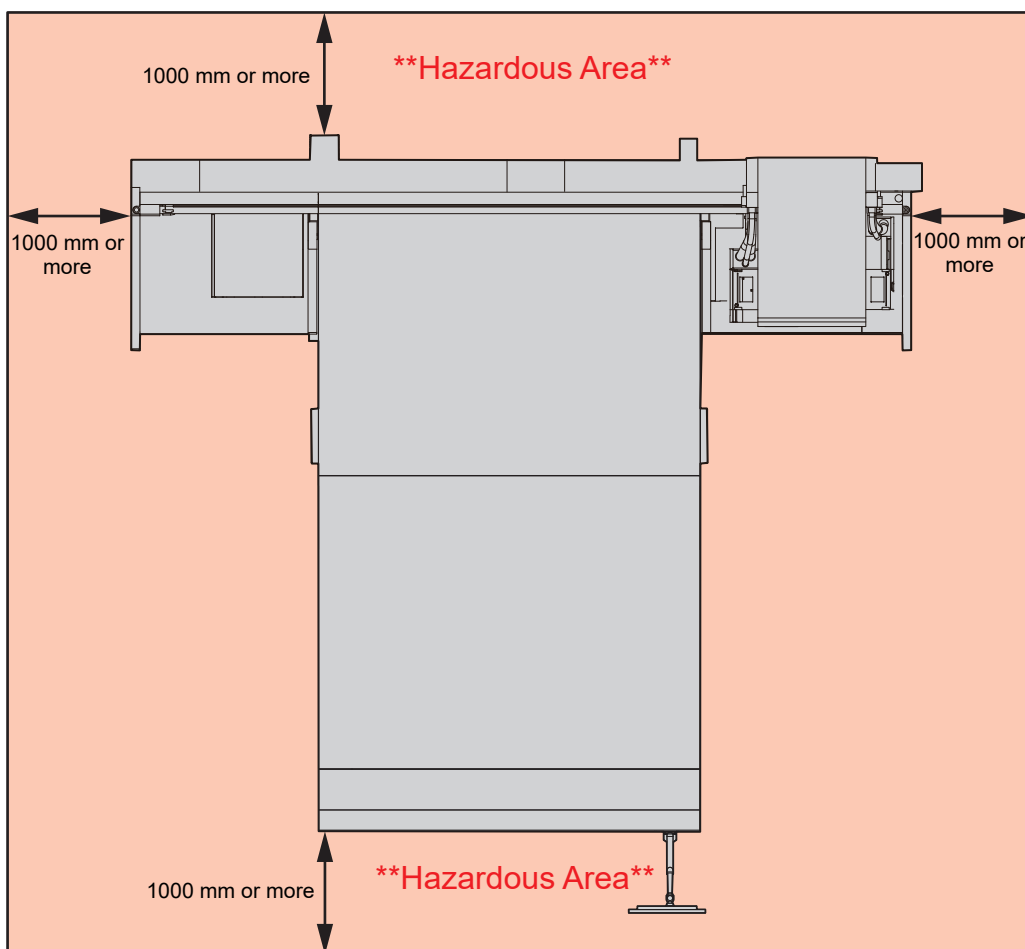

- Be sure to prohibit the handling of the machine by all people except personnel who have undergone our risk assessment training or persons trained by them. Failure to do so may result in injury.

Hazardous and Prohibited Actions

When the power is on, avoid any of the hazardous actions listed below. Failure to observe these precautions may lead to serious injury (crushing or shearing) if the carriage moves during routine maintenance.

● Maintain a safe distance from the area behind the Y-bar.



- Do not walk behind the Y-bar when the power is on. The Y-bar may suddenly start moving, leading to an accident.

● Keep your face, hands, and all other body parts at a safe distance from the carriage area.



- Do not bring your face, hands, or any other part of your body close to or into the gap between the carriage and the Y-bar.

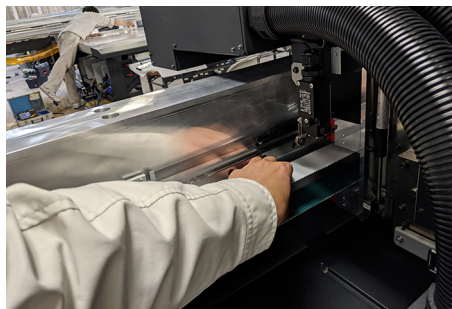

- Do not bring your face, hands, or any other part of your body close to or into the gap between the carriage and table or station.



● Keep your face, hands, and all other body parts at a safe distance from the gap between the Y-bar and table.



- Do not bring your face, hands, or any other body parts close to or into the gap between the Y-bar and table.



- **Keep your face, hands, and all other body parts at a safe distance from moving parts.**



- Do not bring your face, hands, or any other body parts close to or into the Y-bar belt.

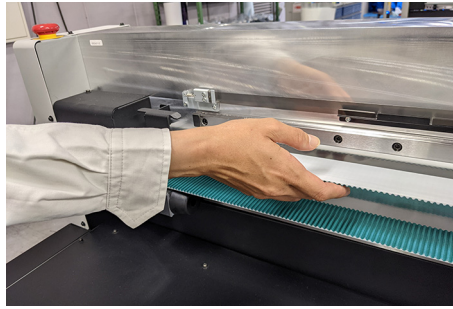

- **Keep your face, hands, and all other body parts at a safe distance from the cable carrier section, and do not place any objects on top.**



- Do not bring your face, hands, or any other body parts close to or into the cable carrier section below the Y-bar and table, and do not place any object on top.



- **Keep your face, hands, and all other body parts at a safe distance from the area under the table.**



- Do not crawl under the table or bring your face, hands, or any other body parts into the space under the table.

- **Keep your hands and other objects off the table.**



- Do not place your face, hands, other body parts, or any objects other than the media on the table.



● **Do not look directly at the UV-LED.**



- Avoid looking directly at the UV-LED. Take special care when working while seated as the carriage will be roughly at eye level.



● **Maintain a safe distance while the carriage is operating.**



- Do not forcibly move the carriage while it is in motion (during printing, cleaning, or other operations).
-

Connecting the Power

The printer requires a large power supply and must be powered directly from the switchboard. Customers must complete any electrical work before the printer is carried in.



- Always connect the machine to a switchboard with grounded polarity. Otherwise there is a risk of failure, electric shock, or fire. All electrical work (Class C grounding work; formerly Type 3 grounding work) must be handled by a licensed electrician.



- Make sure the connections are correct. Incorrect connections may result in damage to the equipment.
- Be careful to avoid problems in wiring configuration.

Wiring method



- The machine electrical box contains three terminal blocks. A power cable is not included. The user is responsible for providing power cables. Electrical work between the switchboard and terminal block must be performed by a licensed electrician.
- Be sure to only use the following types of cables and circuit breakers.

(1) Cable: VCT-5.5 mm² × 3-core (600 V) or UL-AWG10 × 3C (600 V) or equivalent. Outer sheath external diameter 16 to 19.8 mm.

(2) Circuit breaker: Single-phase 200 to 240 V AC, 30 A

● Wire preparation

1 Strip 60 mm of the sheath from the power cable.

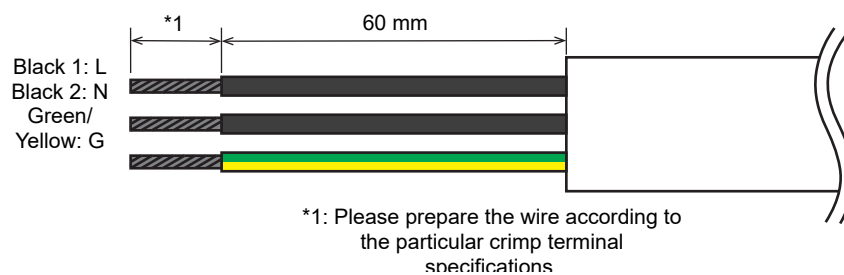

2 Attach one of the cable glands (FGA33-22B) provided to each of the cables.

3 Attach the allowable types of crimp terminals to the live, neutral, and ground wires (L, N, G).

- The sheath must be stripped off the wires to a length that is appropriate for the crimp terminal type you are using.
- For more information regarding allowable crimp terminals, see below.

- Terminal block connection details

(1) Model No.: FPSK-30-2P

(2) Manufacturer: TOYOGIKEN

(3) Terminal screws: M4 x 8 (3-part SEMS screw)

- Live and neutral wire end preparation

(1) Preparation method: Ring terminal with added insulation.

(2) Shape:

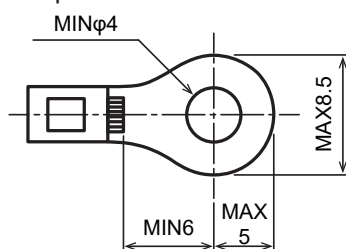

(3) Examples of allowable crimp terminals:

- TMEX5.5-4N (NICHIFU)
- RAV5.5-S4 (Daido Solderless Terminal Mfg.)
- RAV5.5-N4 (Daido Solderless Terminal Mfg.)
- RAV5.5-M4 (Daido Solderless Terminal Mfg.)
- NBT5.5-S4 (Fuji Terminal Industry)
- NBT5.5-SS4 (Fuji Terminal Industry)

- Ground wire end preparation

(1) Preparation method: Ring terminal with added insulation.

(2) Crimp terminal stud diameter: $\phi 5$ or larger

(3) Examples of allowable crimp terminals:

- FN5.5-5 (J.S.T. Mfg.)
- N5.5-5 (J.S.T. Mfg.)

- Screw tightening torque: 1.8 Nm



- Be sure to observe the following three points. Failure to observe the following three points may result in fire, smoke generation, or electric shock.
 - (1) Only use power cables and crimp terminals that satisfy the specifications.
 - (2) Be sure to attach a ring crimp terminal to the end of the power cable.
 - (3) Secure the ring terminal to the terminal block using the specified tightening torque.

● Power connection work

1 Make sure that the machine main power supply and the switchboard circuit breaker have been turned off.

2 Pass each cable through the wiring ports on the right side of the power supply box.

3 Tighten the cable glands with a wrench and secure to the power supply BOXR side.

- Check to confirm that the cable glands do not move once they have been secured.

4 Secure the live and neutral wires of each cable to the terminal block, and then attach the ground wire to the protective ground screw hole indicated by the ground symbol.



- To prevent electric shock, be sure to connect the ground wire before connecting the live and neutral wires.

- The terminal block screws should be tightened to a torque of 1.8 Nm.

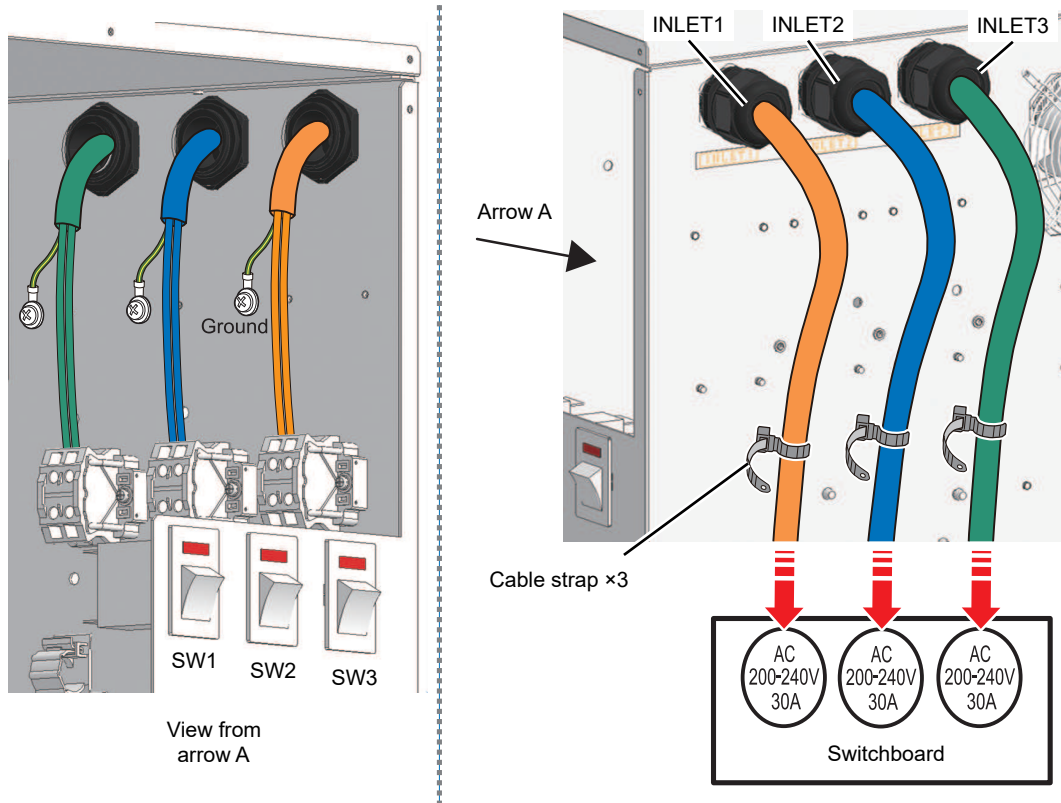

5 After installing the cables, attach cable straps.

6 Tighten the cable gland nuts to secure the cables in place.

- After securing, pull the cables to confirm that they do not move.

Notes on Handling Ink or Any Other Liquid Used with the Machine

Precautions regarding ink, maintenance liquid, or other liquids used with this machine are included with the containers. Thoroughly read them and make sure you understand the contents.



- Be sure to read the safety data sheet (SDS) before use. <https://mimaki.com/supply/sds/>

CAUTION



- Pay close attention to ventilation and be sure to wear safety glasses, gloves, and a mask when handling ink, maintenance liquid, waste ink, or other solutions used with the machine. Leaking ink may adhere to the skin or get into the eyes or mouth.



- Use only genuine Mimaki Engineering anti freezing liquid. Use of other anti freezing liquid may cause failures of the cooling unit.
- Take care to prevent any potential sources of ignition such as sparks caused by static electricity or material impacts.
- Be sure to dispose of any unneeded anti freezing liquid in the following manner.
 - (1) Soak it up with materials such as sawdust or rags and burn them in an incinerator.
 - (2) Pass them onto a licensed industrial waste disposal company after clearly indicating their contents.



- Do not subject cases containing ink to strong shock or violent shaking. Do not attempt to refill the ink. Leaking ink may adhere to the skin or get into your eyes or mouth.



- Do not disassemble cases containing ink. Leaking ink may adhere to the skin or get into your eyes or mouth.



- Do not store ink, maintenance liquid, or other liquids used with the machine in locations where children may enter.



- When disposing of ink, maintenance liquid or other liquid used with the product, or containers or non-woven fabric contaminated with ink or other liquid, contact an industrial waste disposal operator or dispose of the product in accordance with the local laws and regulations.

NOTICE



- Do not store ink, maintenance liquid, or other liquids used with the machine in locations exposed to direct sunlight.
- Do not store ink, maintenance liquid, or other liquids used with the machine in environments where cutting fluid or other volatile substances (such as amines or modified amine alcohol) are present in significant quantities. Storage in such places increases the risk of failure or ejection failures (e.g., nozzle clogging or deflection).
- Do not use ink, maintenance liquid, or other liquids used with this machine with other printers. Doing so may cause failure.



- Be sure to store them in a low place no higher than 1 m above the floor. Otherwise there is a risk of scattering if the containers fall.
- Store in tightly sealed containers.
- Store in a cool, dark place.
 - (1) Store ink in a place where ink does not freeze. Using defrosted ink may deteriorate ink constituents and reduce print quality.
 - (2) When ink is moved from a cold place to a warm place, leave it in the environment where the machine is installed for at least three hours before using it.
 - (3) Open the container just before installing it, and use it up as quickly as possible. If it is opened and left for an extended period of time, print quality may be reduced.



- Do not touch the metal parts of the ink IC chip. Static electricity may damage the ink IC chip, and dirt or damage may cause the ink IC chip read error.



- Printing is not possible when different types of ink IC chips are used.
- If the ink bottle mounted on the machine is dented, it may still be used.

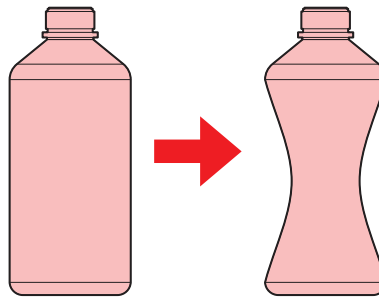

Ink Specifications

| Item | | Details |
|---------------------|-----------------------|--|
| Type | | UV curing ink (MIMAKI product) |
| Color | | Cyan (C) Light cyan (Lc) Magenta (M) Light magenta (Lm) Yellow (Y) Black (K) White (W) Clear ink (Cl) Primer ink (Pr) |
| Form | | Bottle |
| Ink capacity | | 1,000 ml |
| Expiration date | | As indicated on the ink bottle However, after opening, it should be consumed within three months, even if before the expiration date. |
| Storage temperature | When stored | 5 °C to 30 °C (daily mean temperature) However, not more than 1 month at 30 °C <ul style="list-style-type: none"> • Ink quality may deteriorate if stored outside these conditions. |
| | During transportation | 1 °C to 60 °C However, not more than 120 hours at 60 °C, and not more than 1 month at 40 °C <ul style="list-style-type: none"> • Where possible, avoid storing in cold locations below 0 °C and hot locations above 40 °C. |

| Item | Details |
|------|---|
| | • Ink quality may deteriorate if stored outside these conditions. |

Restrictions Concerning the Expiration Date of Ink Used in the Machine

Example: When the expiration date is April 20xx

- May 20xx: Replace with new ink or use up as quickly as possible. Printing is possible.
- June 20xx: Replace with new ink or use up as quickly as possible. Printing is possible.
- July 20xx: Printing is not possible.

Important!

- The ink expiration date is indicated on the ink container. Expired ink may cause ejection failures or alter the color tone. Printing is possible even if the ink has passed its expiration date. Nevertheless, we recommend replacing with new ink or using up as quickly as possible.
-

Installation Precautions

⚠ WARNING



- Do not install the machine in a place close to fire.
- Do not place flower vases, pots, cups, containers containing cosmetics, chemicals or water, or small metal items on or close to the machine. If they enter the machine, there is a risk of failure, electric shock, or fire.



- Do not install this machine in humid locations or locations where it may be exposed to splashing water. Otherwise there is a risk of failure, electric shock, or fire.



- Do not install the machine in a place where children may enter.

⚠ CAUTION



- A ventilation system must be provided if this machine is installed in a poorly ventilated area or sealed room.
- Be sure to observe the following points when installing an extractor outlet:
 - (1) The extractor outlet must be installed in accordance with applicable local EHS (environmental, health, and safety) guidelines.
 - (2) If the extractor outlet is fitted with a shutoff valve, the valve must be open when this machine is in use.

NOTICE



- Do not install this machine in locations where dust or powder is present. Failure or printing defects may result (e.g., nozzle clogging, deflection) if dust gets inside this machine.
- Do not install this machine in locations exposed to drafts (e.g., from air conditioning). Disregarding this precaution may result in dust or powder getting inside this machine.
- Do not install this machine in unstable locations or locations subject to vibration. This will increase the risk of failure or printing defects (e.g., nozzle clogging, deflection).
- Do not install this machine in locations exposed to direct sunlight.
- Do not install this machine in locations subject to sudden temperature changes. This will increase the risk of failure or printing defects (e.g., nozzle clogging, deflection).
- Do not install this machine in locations exposed to excessive noise from large machinery.
- Do not install this machine in locations where photographic fixing agents generate vapor or acid gas (e.g., acetic acid, hydrochloric acid) or locations filled with metal working fluids or highly volatile substances (e.g., amines, amine-modified alcohols). Malfunctions or printing defects may result (e.g., nozzle clogging, deflection) as print head ink is more likely to harden under such environments.



- Operating environment: 20 to 30 °C (68 to 86 °F), 35 to 65 %RH (no condensation)
- Temperature range in which accuracy is guaranteed: 20 to 25 °C (68 to 77 °F)

Installation Space

Provide the following space around the machine to allow safe and proper replacement of ink and media:

| Item | JFX600-2531 |
|----------------------|--|
| Width ^{*1} | At least 7,400 mm (not exceeding 5,400 mm) |
| Depth ^{*1} | At least 7,600 mm (not exceeding 5,600 mm) |
| Height ^{*1} | (Not exceeding 1,700 mm) |
| Weight | (Not exceeding 1,500 kg) |

*1. The values shown in parentheses indicate the size of the machine when the touch panel is included.

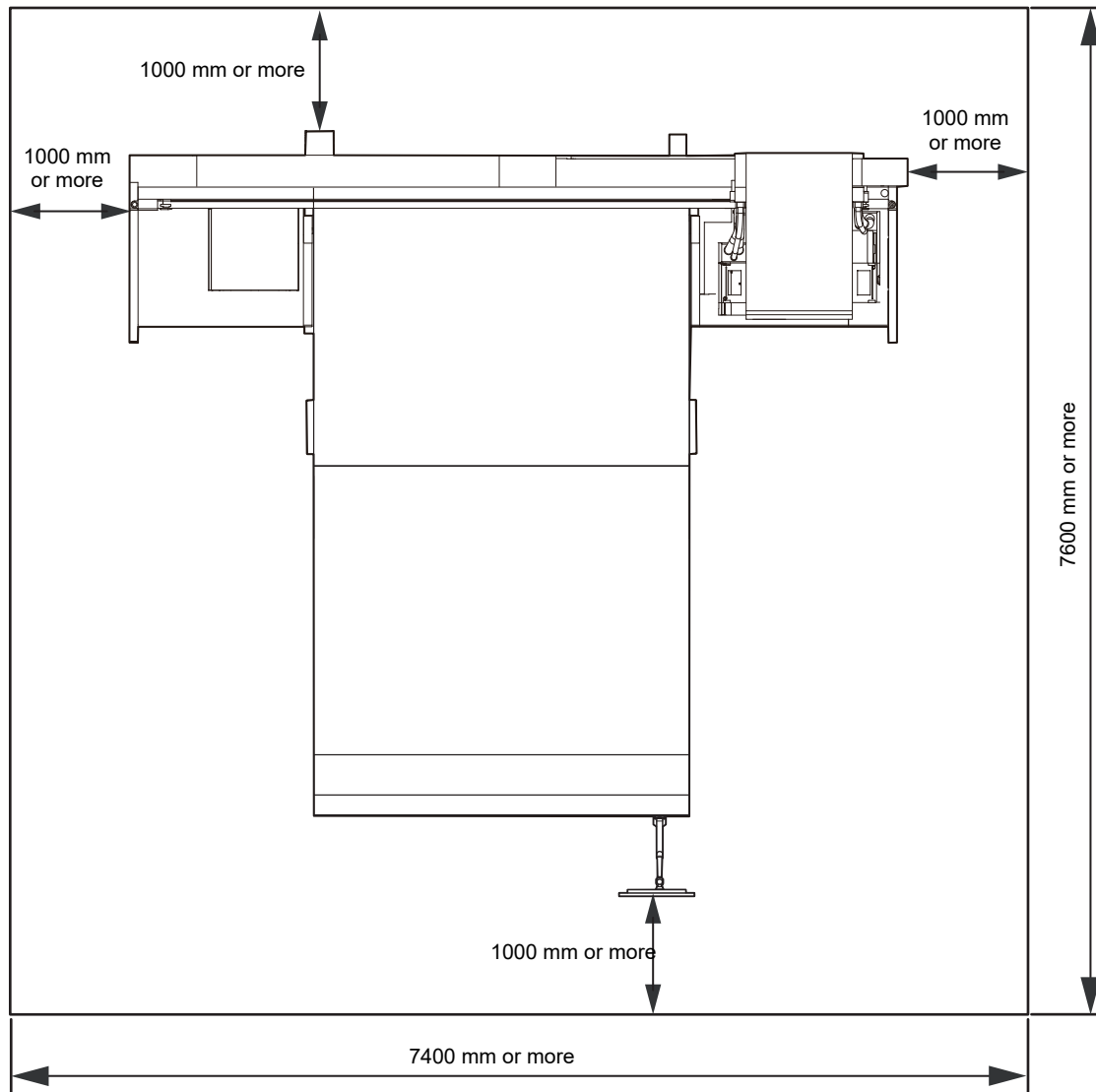

- Physically isolate the machine, such as enclosing it in a special room or area surrounded by safety fences. Take appropriate steps to clearly indicate that this is a hazardous area.
 - Any special room provided should incorporate a door that can be locked or has a safety interlock.
 - Any safety fences used must conform to the EN ISO 13857 standards.

Adjuster Feet

Before turning the machine on, ensure that the adjuster feet are firmly secured. If adjuster feet are loose, the machine may move during printing, resulting in injuries.

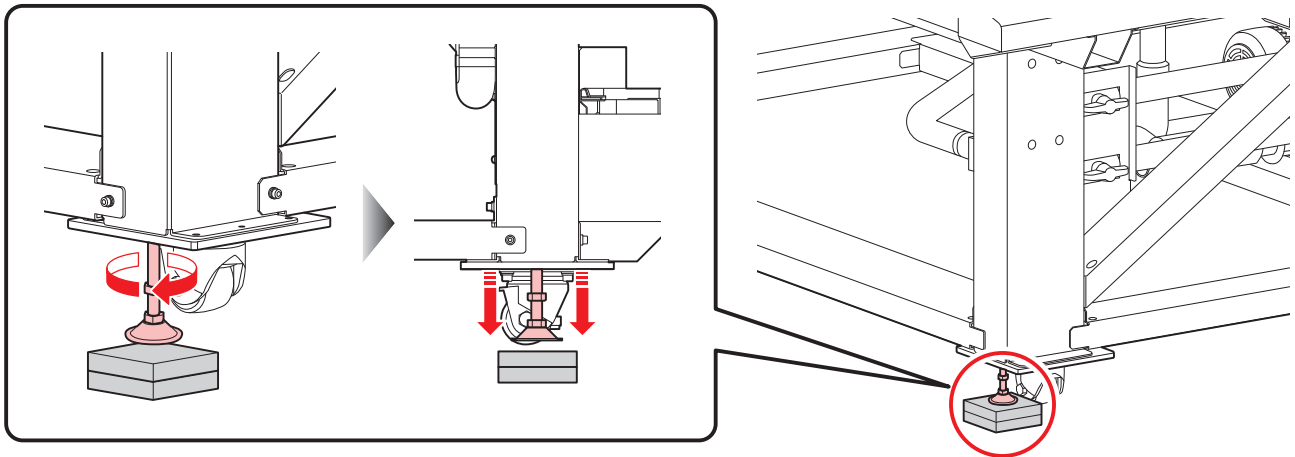

- Do not remove the floor plate (made of resin, color: gray). The floor plate helps to evenly distribute the weight of the machine.

When Relocating This Machine







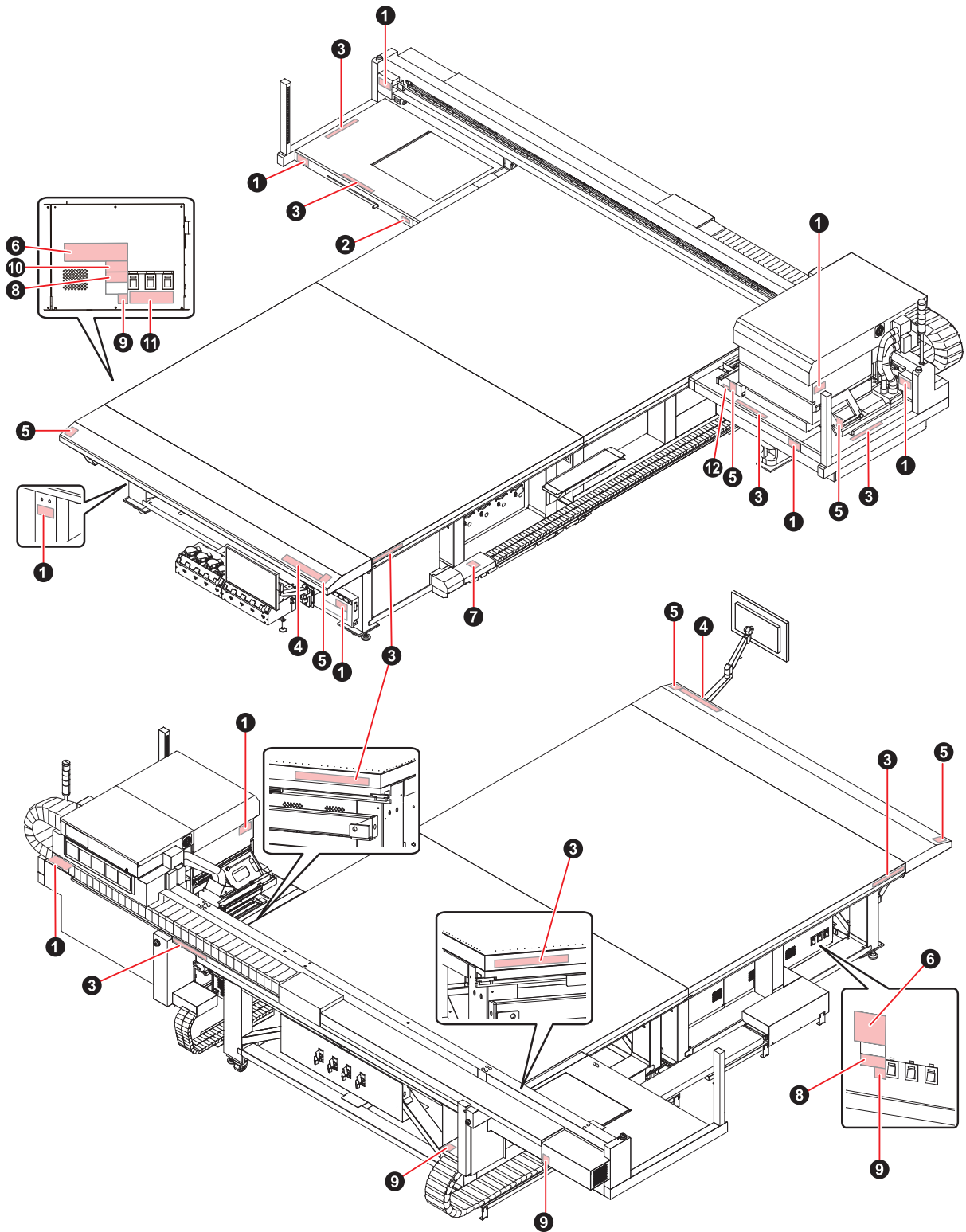

Contact your local dealer or our service office. Attempting to handle relocation yourself may result in failure or damage.

Warning Labels

Make sure you fully understand the details indicated on the various warning labels.

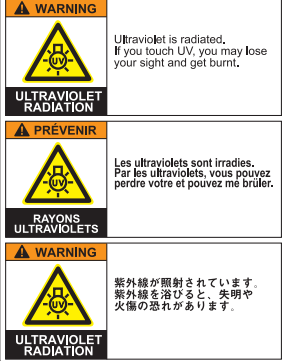
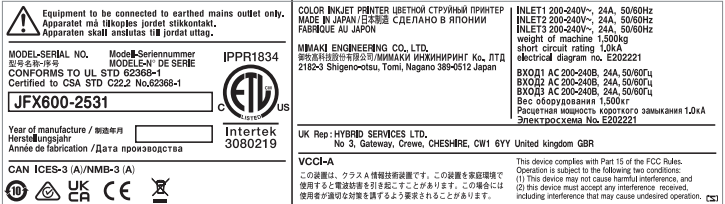
If any of the warning labels become dirty and illegible or peel off, contact your local dealer or our service office to request new warning labels.



| N o. | Order code | Label | Details |
|------|------------|--|---|
| 1 | M909381 |  | Be careful of moving parts. |
| 2 | M903330 |  | Wear safety glasses and gloves while working. |
| 3 | M906115 |  | Be careful of moving parts. |
| 4 | M902663 |  | Be careful of moving parts. |
| 5 | M905980 |  | Be careful of UV light. |
| 6 | M919074 |  | - |
| 7 | M909385 |  | Do not stand or sit on the machine. |
| 8 | M903281 |  | Take care when connecting the power cable. |
| 9 | M907935 |  | Be careful of high voltage. |

| N o. | Order code | Label | Details | | | | | | | | |
|--|--|---|--------------|---|--------------------------------|--|-------------------------|--|---|--|--|
| 10 | M905624 | <table border="1" style="width: 100%; border-collapse: collapse;"> <tr> <td style="width: 50%; text-align: center; background-color: #f96;">⚠ 警告</td> <td style="width: 50%; text-align: center; background-color: #f96;">⚠ WARNING</td> </tr> <tr> <td style="text-align: center;">漏えい電流大 電源へ接続する前に 接地接続が必要</td> <td style="text-align: center;">HIGH LEAKAGE CURRENT EARTH CONNECTION ESSENTIAL BEFORE CONNECTING SUPPLY</td> </tr> <tr> <td style="text-align: center; background-color: #f96;">⚠ AVERTISSEMENT</td> <td style="text-align: center; background-color: #f96;">⚠ WARNUNG</td> </tr> <tr> <td style="text-align: center;">COURANT DE FUITE ELEVE CONNECTER LA MISE A LA TERRE AVANT DE CONNECTER L'ALIMENTATION</td> <td style="text-align: center;">HOHER KRIECHSTROM BITTE ERDKABEL ANSCHLIESSEN BEVOR SIE STROMZUFUHR ANSCHLIESSEN</td> </tr> </table> | ⚠ 警告 | ⚠ WARNING | 漏えい電流大 電源へ接続する前に 接地接続が必要 | HIGH LEAKAGE CURRENT EARTH CONNECTION ESSENTIAL BEFORE CONNECTING SUPPLY | ⚠ AVERTISSEMENT | ⚠ WARNUNG | COURANT DE FUITE ELEVE CONNECTER LA MISE A LA TERRE AVANT DE CONNECTER L'ALIMENTATION | HOHER KRIECHSTROM BITTE ERDKABEL ANSCHLIESSEN BEVOR SIE STROMZUFUHR ANSCHLIESSEN | Be careful of current leakage. ([PROTECTIVE CONDUCTOR CURRENT] = 13.2 mA.) |
| ⚠ 警告 | ⚠ WARNING | | | | | | | | | | |
| 漏えい電流大 電源へ接続する前に 接地接続が必要 | HIGH LEAKAGE CURRENT EARTH CONNECTION ESSENTIAL BEFORE CONNECTING SUPPLY | | | | | | | | | | |
| ⚠ AVERTISSEMENT | ⚠ WARNUNG | | | | | | | | | | |
| COURANT DE FUITE ELEVE CONNECTER LA MISE A LA TERRE AVANT DE CONNECTER L'ALIMENTATION | HOHER KRIECHSTROM BITTE ERDKABEL ANSCHLIESSEN BEVOR SIE STROMZUFUHR ANSCHLIESSEN | | | | | | | | | | |
| 11 | M917898 | <table border="1" style="width: 100%; border-collapse: collapse;"> <tr> <td style="text-align: center; background-color: #f96;">⚠ CAUTION</td> </tr> <tr> <td style="text-align: center;">There are more than one disconnections. Make sure that all switches are disconnected before access. There will be an electric shock if any of the switches are not disconnected</td> </tr> <tr> <td style="text-align: center; background-color: #f96;">⚠ ATTENTION</td> </tr> <tr> <td style="text-align: center;">Il y a plus d' une deconnexion. S' assurer que tous les commutateurs sont deconnectes avant d' acceder. Il y a risque de choc electrique si l' un des commutatens n' est pas deconnecte.</td> </tr> <tr> <td style="text-align: center; background-color: #f96;">⚠ 警告</td> </tr> <tr> <td style="text-align: center;">本装置には複数の入力電源があります。 電装BOXを開ける場合は、必ず全てのスイッチを切り、 電源遮断装置（ブレーカ等）で全ての供給電源遮断を行うこと。 感電や火災につながるおそれがあります。 CS</td> </tr> </table> | ⚠ CAUTION | There are more than one disconnections. Make sure that all switches are disconnected before access. There will be an electric shock if any of the switches are not disconnected | ⚠ ATTENTION | Il y a plus d' une deconnexion. S' assurer que tous les commutateurs sont deconnectes avant d' acceder. Il y a risque de choc electrique si l' un des commutatens n' est pas deconnecte. | ⚠ 警告 | 本装置には複数の入力電源があります。 電装BOXを開ける場合は、必ず全てのスイッチを切り、 電源遮断装置（ブレーカ等）で全ての供給電源遮断を行うこと。 感電や火災につながるおそれがあります。 CS | There is more than one power supply switch. Turn off all three switches when turning off the power to prevent the risk of electric shock. | | |
| ⚠ CAUTION | | | | | | | | | | | |
| There are more than one disconnections. Make sure that all switches are disconnected before access. There will be an electric shock if any of the switches are not disconnected | | | | | | | | | | | |
| ⚠ ATTENTION | | | | | | | | | | | |
| Il y a plus d' une deconnexion. S' assurer que tous les commutateurs sont deconnectes avant d' acceder. Il y a risque de choc electrique si l' un des commutatens n' est pas deconnecte. | | | | | | | | | | | |
| ⚠ 警告 | | | | | | | | | | | |
| 本装置には複数の入力電源があります。 電装BOXを開ける場合は、必ず全てのスイッチを切り、 電源遮断装置（ブレーカ等）で全ての供給電源遮断を行うこと。 感電や火災につながるおそれがあります。 CS | | | | | | | | | | | |
| 12 | M917420 | <table border="1" style="width: 100%; border-collapse: collapse;"> <tr> <td style="text-align: center; background-color: #f96;">RISK GROUP 3</td> </tr> <tr> <td style="text-align: center;">• WARNING UV emitted from this product. • Avoid eye and skin exposure to unshielded product.</td> </tr> <tr> <td style="text-align: center; background-color: #f96;">GROUPE DE RISQUE 3</td> </tr> <tr> <td style="text-align: center;">• AVERTISSEMENT : UV emis par ce produit. • Eviter l' exposition des yeux et de la peau a un produit non blinde. CS</td> </tr> </table> | RISK GROUP 3 | • WARNING UV emitted from this product. • Avoid eye and skin exposure to unshielded product. | GROUPE DE RISQUE 3 | • AVERTISSEMENT : UV emis par ce produit. • Eviter l' exposition des yeux et de la peau a un produit non blinde. CS | Be careful of UV light. | | | | |
| RISK GROUP 3 | | | | | | | | | | | |
| • WARNING UV emitted from this product. • Avoid eye and skin exposure to unshielded product. | | | | | | | | | | | |
| GROUPE DE RISQUE 3 | | | | | | | | | | | |
| • AVERTISSEMENT : UV emis par ce produit. • Eviter l' exposition des yeux et de la peau a un produit non blinde. CS | | | | | | | | | | | |



- Use the machine with a power supply that meets specifications.
- Be sure to plug the power cable into a power outlet close to the machine. Insert the power plug blade securely.
- When connecting the power cable, check the input voltage of the power outlet and the capacity of the breaker. Also, connect each cable to a separate power source with an independent breaker. Connecting to power outlets linked with the same breaker will cause the breaker to trip.



- Always connect the machine to a switchboard with grounded polarity. Otherwise there is a risk of failure, electric shock, or fire. All electrical work (Class C grounding work; formerly Type 3 grounding work) must be handled by a licensed electrician.

Chapter 1 Before Use



This chapter

This chapter describes information essential before use, such as part names.

| | | | |
|-------------------------------------|----|---|----|
| Part Names and Functions | 30 | Preparing the RIP PC | 38 |
| Carriage | 32 | Setting up an Ethernet connection | 38 |
| Capping station | 32 | Installing the Mimaki Driver | 41 |
| Ink Status Lamp | 32 | Installing RIP Software | 42 |
| Signal tower light | 33 | Obtaining Color Profiles | 42 |
| Light Curtain | 34 | Setting Up RIP Software | 42 |
| System Configuration | 35 | Ink Replacement Method | 44 |
| Connecting to a Local Network | 36 | When Ink Near End is Displayed | 44 |
| | | When Ink End is Displayed | 44 |
| | | Replacing Ink | 45 |

1.1 Part Names and Functions

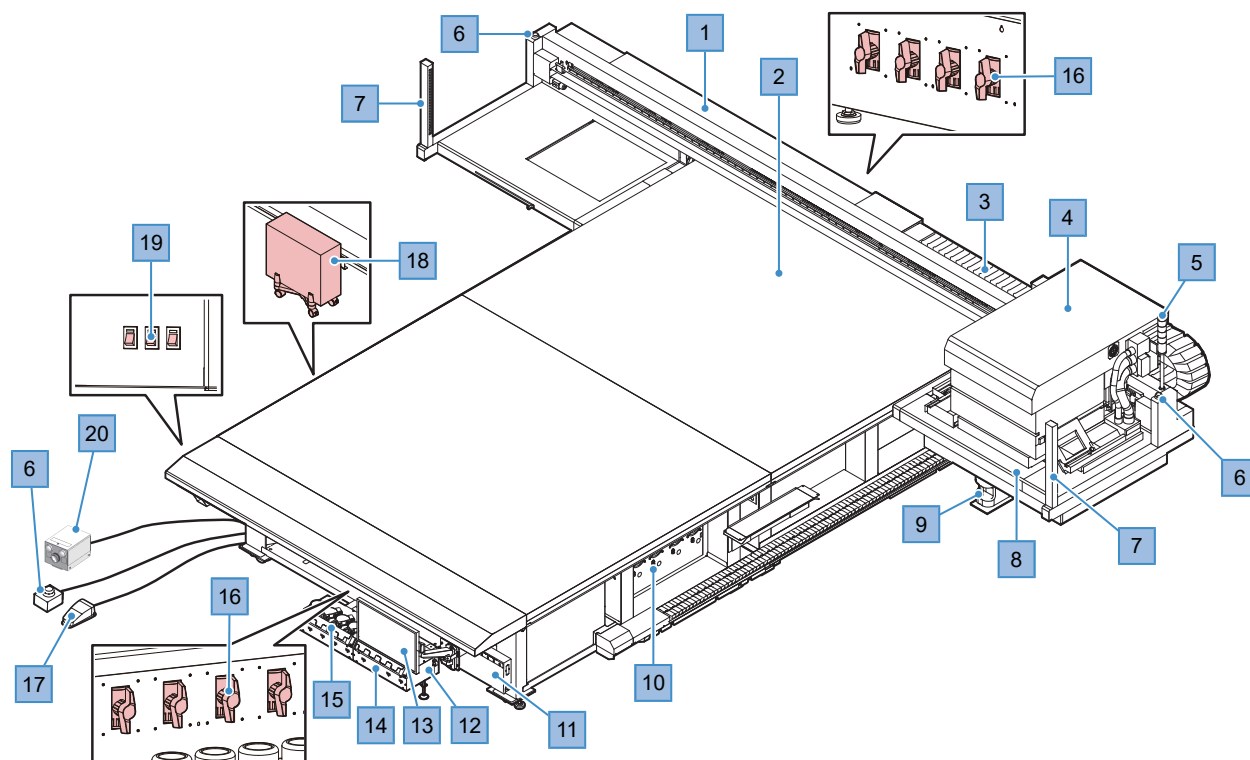

| No. | Name | Overview |
|-----|-----------------------|---|
| 1 | Y-bar | The Y-bar is equipped with a carriage. This part moves over the table to print. |
| 2 | Table | Print area. The table secures the media under vacuum pressure. "Loading the Media"(P. 59) |
| 3 | Cable carrier (Y-bar) | Ink tubes and other parts are routed through the cable carrier. Do not insert your hands or other objects into the cable carrier. |
| 4 | Carriage | Consists of a print head, a UV-LED lamp, and the jam sensor. "Carriage"(P. 32) |
| 5 | Signal tower light | To confirm machine status, check the color of the illuminated lights. A buzzer sounds to signal that the carriage and Y-bar will begin moving soon. "Signal tower light"(P. 33) |
| 6 | Emergency stop switch | Press to stop the machine in emergencies. Two emergency stop switches are positioned at the left and right ends of the Y-bar. An additional switch on an extension can be kept in a separate room or in an area behind a safety partition. <ul style="list-style-type: none"> When you stop the machine by pressing the emergency stop switch, follow the steps below to unlock the switch. <ol style="list-style-type: none"> Resolve the problem. Rotate the emergency stop switch to unlock it. Clear the alarm on the touch panel. "Clearing Alarms"(P. 109) <ul style="list-style-type: none"> Clearing the alarm will start the initial operations. |
| 7 | Light Curtain | Detection of a person or object will halt the machine. "Light Curtain"(P. 34) |
| 8 | Capping station | Includes caps, wipers, and an NCU for monitoring print head nozzle conditions. "Capping station"(P. 32) |
| 9 | Waste ink tank | Container for waste ink. "Waste Ink Tank Replacement"(P. 149) |

| No. | Name | Overview |
|-----|------------------------------------|--|
| 10 | Cooling water unit | Cooling water (mixed with antifreeze) is used to cool the UV-LED unit, which heats with use. "Refilling Cooling Water (Mixed With Antifreeze)"(P. 150) |
| 11 | Ink status lamp | This lamp indicates ink status. "Ink Status Lamp"(P. 32) |
| 12 | Ink Supply Unit | The ink bottle is inserted here to supply ink to the print head. "Replacing Ink"(P. 45) |
| 13 | Touch panel | The touch panel is used to control the machine. "Mimaki Printer Controller"(P. 106) <ul style="list-style-type: none"> • How to operate the touch panel <ul style="list-style-type: none"> – Tap: Select a function. – Long tap: Select multiple jobs. – Swipe: Move the screen up or down. |
| 14 | Ink IC chip slot | The ink IC chip provided with the Ink bottle is inserted here. This manages information on the Ink bottle. "Replacing Ink"(P. 45) |
| 15 | Ink wipe filter | Filter for soaking up ink droplets from special caps "Bottle Ink Wipe Filter Replacement"(P. 148) |
| 16 | Media suction valves | Sets the area where suction is applied to hold the media. "Load the media."(P. 60) |
| 17 | Foot switch (for suction) | Press to hold down/release media on/from the table. "Load the media."(P. 60) |
| 18 | Control PC | Controls the machine. Do not turn off the control PC. "System Configuration"(P. 35) |
| 19 | Main power switch | The main power supply for the machine. To prevent print head ejection failures (such as nozzle clogging or deflection), do not turn off the main power supply. "Power Supply"(P. 124) |
| 20 | Light curtain mode selector switch | Selects the light curtain operating mode. "Light curtain mode selection"(P. 34) |

Carriage

The carriage incorporates print heads that discharge ink, a UV-LED lamp for curing UV ink, and a jam sensor that stops the carriage in case of media jamming. Printing occurs as ink is ejected while traversing left and right.

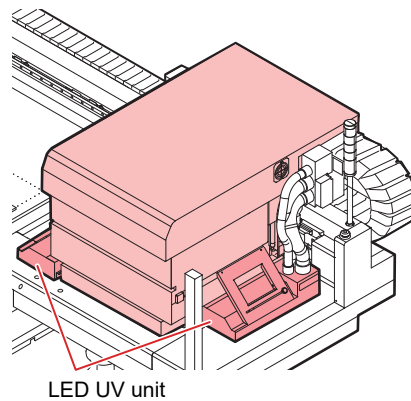

- Be sure to use the UV safety glasses provided. Disregarding this precaution may result in eye pain or damage to eyesight.

Capping station

The capping station includes caps for keeping the print head nozzle surface from drying out, a wiper required for print head maintenance, and an NCU for monitoring print head nozzle conditions.

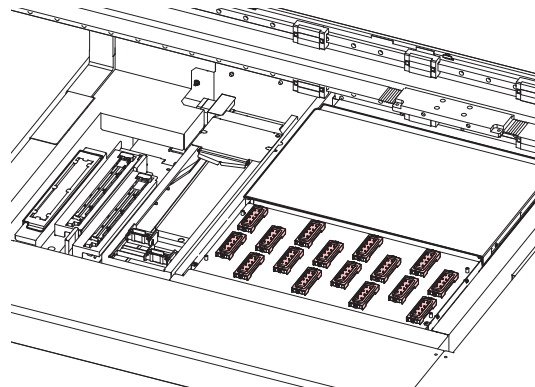

The NCU (Nozzle Check Unit) automatically checks whether the nozzle is clogged. Setting various functions enables automatic print head cleaning or printing using other nozzles. ["Nozzle Check Before Print"\(P. 113\)](#)

Ink Status Lamp

You can check the status of the ink by looking at the lamp on the ink supply unit.

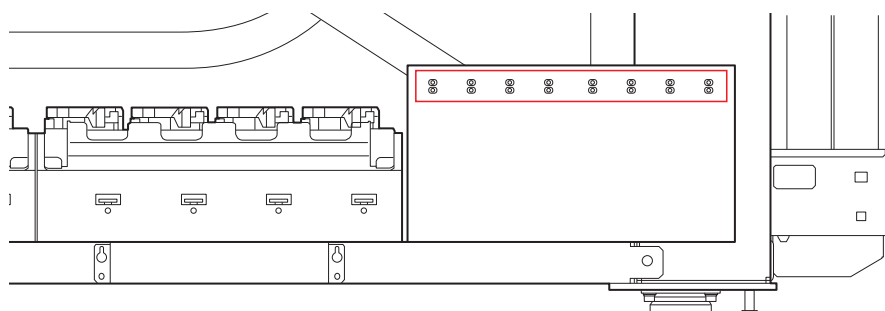

| Color | Status | Overview |
|-----------|--------------------|---|
| - | Off | No error |
| Green | Illuminated | Ink is being supplied (no error) |
| Red | Flashing | One of the following errors has occurred: Printing is possible. <ul style="list-style-type: none"> • INK NEAR-END • Ink has expired (1 months passed) |
| | Illuminated | One of the following errors has occurred: Printing is not possible. <ul style="list-style-type: none"> • Ink End • The ink IC chip is not inserted. • Other ink errors |
| | Flashing (fast) | Printing is not possible. <ul style="list-style-type: none"> • Ink has expired (2 months passed) |
| Green/Red | Lit in alternation | Ink is being supplied, but an error has occurred. |

Signal tower light

To confirm machine status, check the color of the illuminated lights.

A buzzer also sounds to signal that the carriage is about to move.

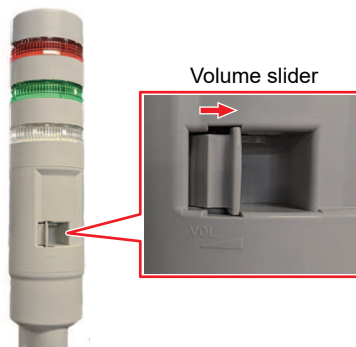

| Color | Status | Overview |
|-------|-------------|---|
| Red | Flashing | An error has occurred. Check the touch panel for error details and resolve the problem. 📖 "Problems Causing Messages to Appear"(P. 161) |
| Green | Illuminated | Indicates printing is underway. |
| White | Illuminated | Media is being held in place by suction. |



- For safety, set the buzzer to full volume.

Light Curtain

Detection of a person or object will halt the machine.

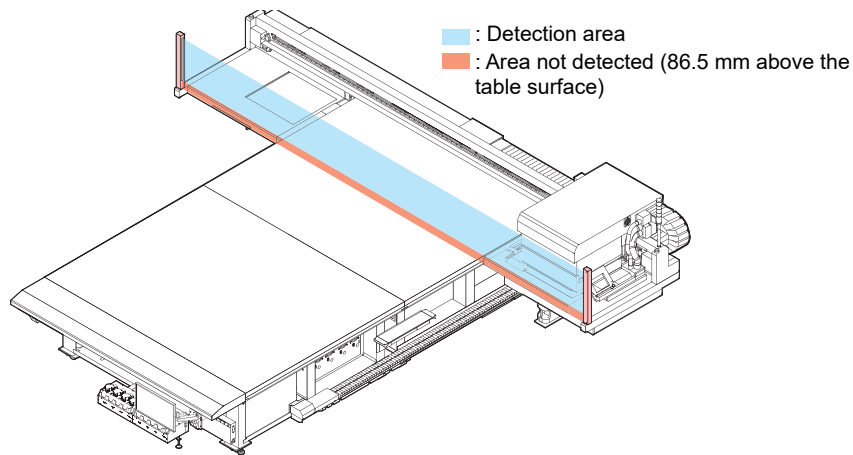

- Objects 86.5 mm from the table surface cannot be detected. Parts of the body or other objects in this area cannot be detected. This can pose serious hazards because the carriage does not stop moving.

Light curtain mode selection

The JFX600-2531 is equipped as standard with a light curtain mode selector switch. Two different modes are available to suit operating requirements.



- In mode 2, operation continues even when a person or obstruction is detected by the light curtain in order to improve operation performance. Keep your hands and any other parts of your body away from the carriage movement area. Failure to do so may result in injury.

| | Mode 1 | Mode 2 |
|---|--------------|--------------|
| Obstruction detected during operation | Stop | Continuous |
| New operation started when obstruction detected | Not possible | Not possible |

1.2 System Configuration

Use RIP software to prepare jobs (RIP data) from print data created in applications such as Illustrator or Photoshop.

Jobs prepared this way are printed using the MPC (Mimaki Printer Controller) application installed on the machine (control PC).  "Settings (MPC)"(P. 105)

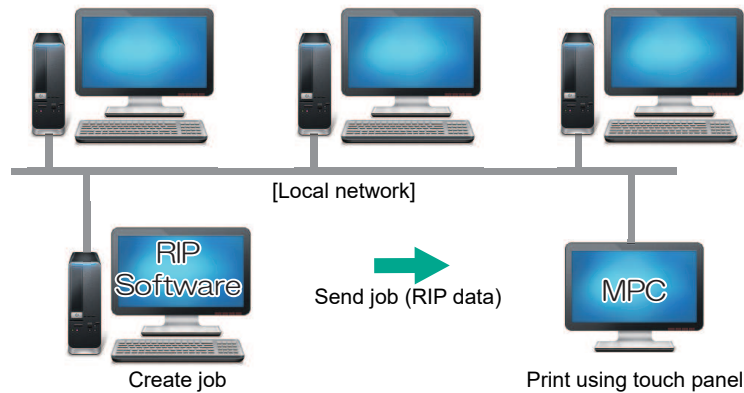

● Control PC



- Do not use a web browser if the control PC is connected to the Internet. Using a web browser may create security risks.
- Do not install any software other than that specified by Mimaki on to the control PC. Do not use other than for the MPC. Installing other software may cause serious problems, such as preventing the product from starting up and preventing printing.
- The control PC is connected to the machine with a LAN cable. Never disconnect the LAN cables connected to the machine, as shown in the red frames below.



Connecting to a Local Network

Connect the machine (control PC) and RIP PC via a local network or direct LAN cable to enable jobs (RIP data) to be easily imported. Insert the LAN cable until it clicks into place.

● Machine (control PC) and RIP PC configuration

The machine can be connected using one of the following two methods:

- Connection using a LAN cable

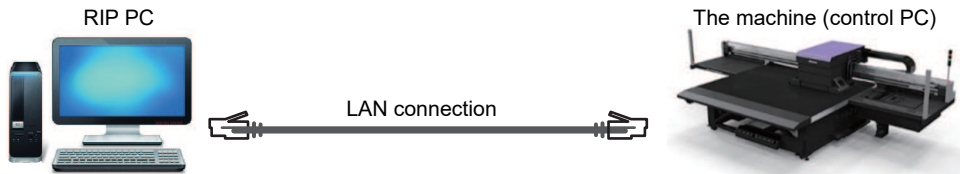

- Connection via a local network

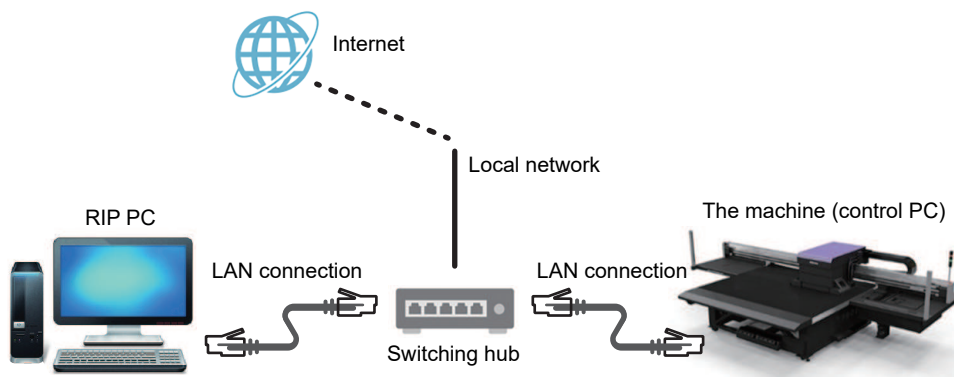

● LAN connection precautions

- Set up the control PC and the RIP PC to transfer print data on the same network. Connections via a router or using Wi-Fi are not possible.
- The following connection devices should be used for a local network connection.

| Device | Required | Recommended |
|-----------------|------------------|-----------------|
| RIP PC LAN port | 1 Gbps or higher | 10 Gbps |
| LAN cable | CAT6A or higher | CAT6A or higher |
| Switching hub | 1 Gbps or higher | 10 Gbps |

LAN connection checking method

● Check the machine (control PC) status

Check the LAN connector indicators near the bottom on the back of the control PC.

- The LAN connector indicators are illuminated when the system is connected.

- If the indicators are not illuminated, insert the LAN cable until it clicks into place.

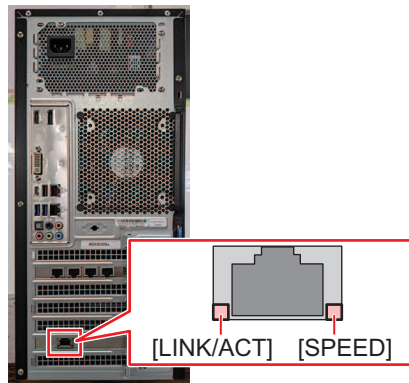

| LED | Status | Overview |
|----------|----------------|---|
| SPEED | Green | Linked via 10GBASE-T |
| | Yellow | Linked over a connection other than 10GBASE-T |
| LINK/ACT | Flashing green | Data is being sent and received. |
| | Green | No network traffic. |



- Do not unplug the cable while data is being transferred.

● Check the touch panel

Check [Network setting] on the touch panel.



- Be sure to confirm whether the LAN connector indicator is lit before configuring the following settings.
- From MENU on the touch panel, tap [SETTING 2] > [System setting] > [Network setting]. Check the dialog box. If the LAN connection has been successfully established, the address will be displayed.

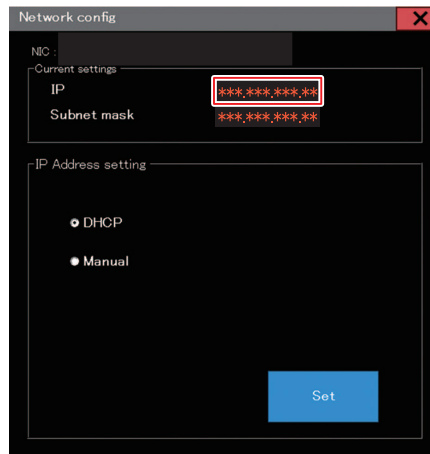

1.3 Preparing the RIP PC

Setting up an Ethernet connection

Sharing a Network

- 1 On the RIP PC, open the Windows start menu and click [Settings].

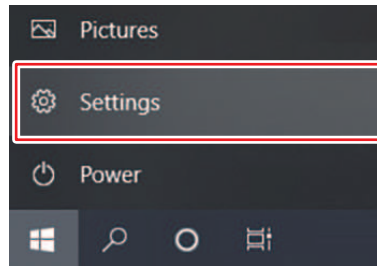

- 2 Select [Network & Internet].

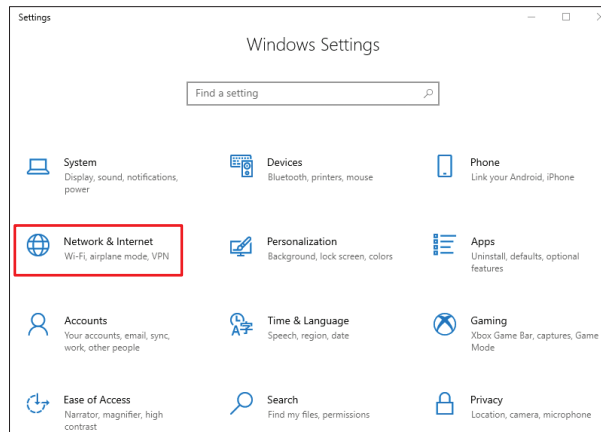

- 3 Under the "Change your network settings" section, select [Network and Sharing Center].

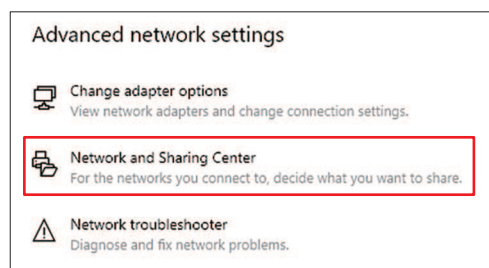

- 4 Select [Private], [Guest or Public], or [Domain].

- The selection items may vary depending on the network configuration. Contact your network administrator.

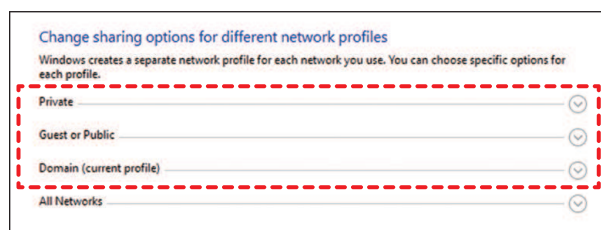

5 Select [Turn on network discovery] and click [Save changes].

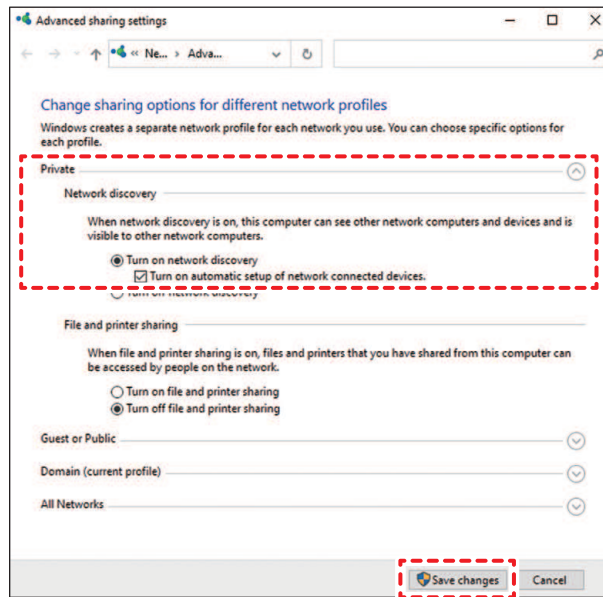

6 Restart the RIP PC.

Setting up an Ethernet connection

1 On the RIP PC, open the Windows start menu and click [Settings].

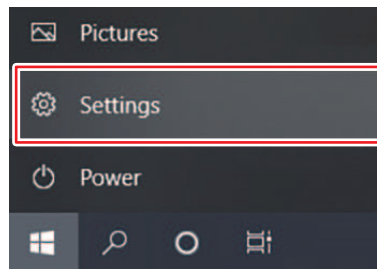

2 Select [Network & Internet].

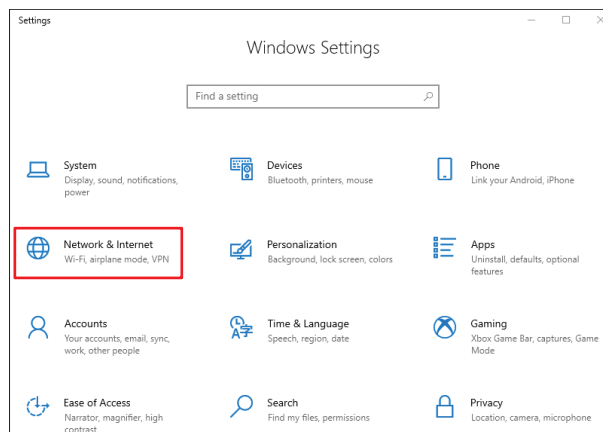

3 Select [Change adapter options].

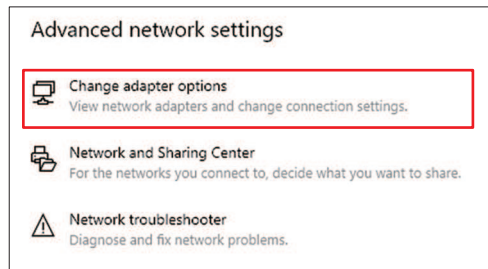

4 Right-click [Ethernet], and then select [Properties].

- If there are multiple [Ethernet] icons, select the properties for the port you wish to use.
- The names may vary depending on the PC.

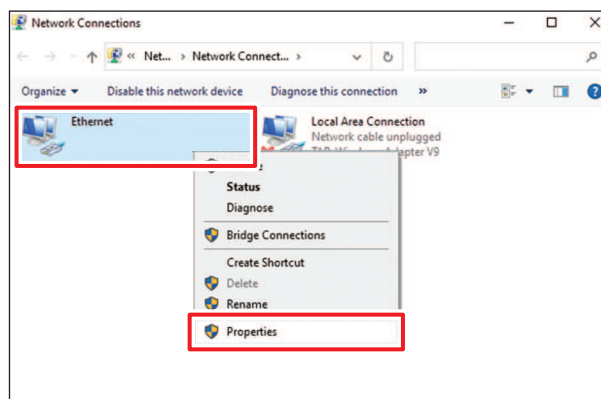

5 On the Networking tab, select the [Internet Protocol Version 4 (TCP/IPv4)] item, then click [Properties].

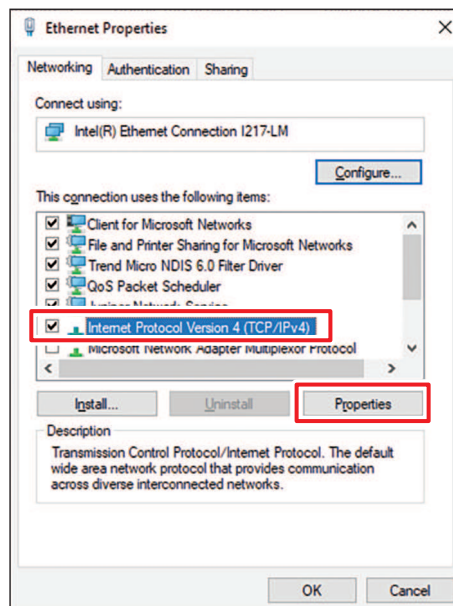

6 Configure the network settings.

- Configure the network according to the network settings of the control PC.
- For more information regarding the network settings of the control PC and RIP PC, contact your network administrator.

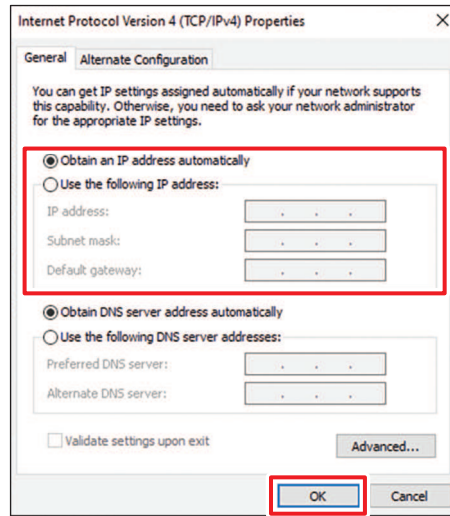

7 Restart the RIP PC.

8 Confirm that the connection has been established.

- Connect the RIP PC and control PC via a LAN cable. ["Connecting to a Local Network"\(P. 36\)](#)

9 Open Explorer on the RIP PC and enter [\machine serial number] in the address bar.

- The machine serial number can be checked on the touch panel (MENU > [SYSTEM] > [System information]).

10 Check the Explorer display.

- Check whether two folders, [HotFolder] and [SharedJob], are displayed. If they are displayed, configuration is complete.

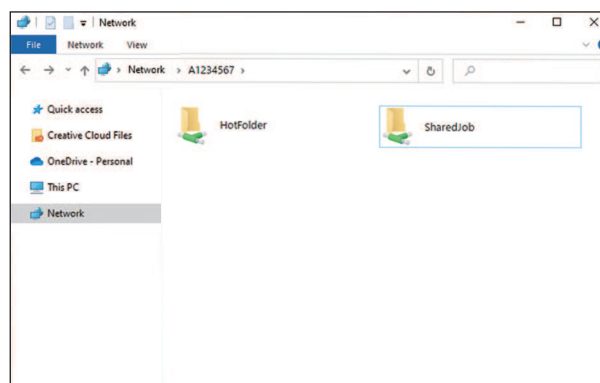

Installing the Mimaki Driver

1 Download the Mimaki driver from our website.

- <https://mimaki.com/download/inkjet.html>
[JFX600-2531] > [Driver/Utility]

2 Install the MIMAKI driver.

Installing RIP Software

The explanation here applies to MIMAKI RIP software (RasterLink).

1 Install RasterLink.

- The following icon appears on the PC desktop once the software has been installed.



- For more information, refer to the RasterLink installation guide. <https://mimaki.com/download/software.html>

Obtaining Color Profiles

Print quality (e.g., tone, bleeding) will vary depending on the media and ink set. To maintain consistent print quality, select a color profile that suits the media and ink set.

- The RasterLink Series includes a function allowing color profiles to be downloaded and installed directly from the Internet. For more information, refer to "Installing Profiles" in the RasterLink Series installation guide.
<https://mimaki.com/download/software.html>
 [RasterLink Series used] > [Manuals]

Setting Up RIP Software

The explanation here applies to MIMAKI RIP software (RasterLink).

1 Launch RasterLink.

- The [Printer Management] screen appears.
- To add a new model, launch RasterLink, then select [Environment] > [Printer Management].

2 Register JFX600-2531.

(1) Click [Add].

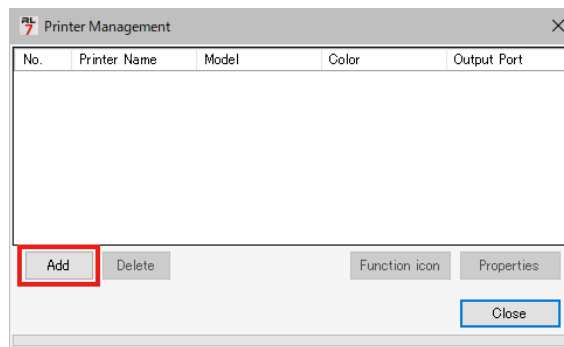

(2) Set the specifics for JFX600-2531.

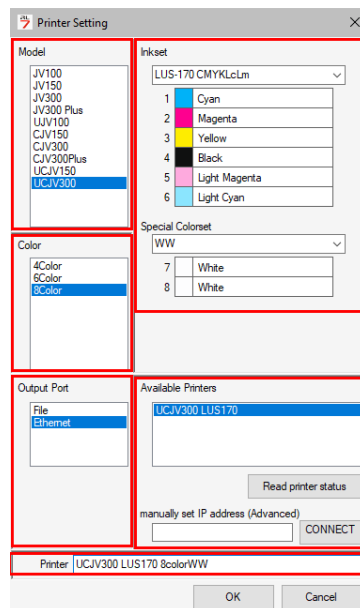

- Model: Select the model.
 - Color: Select the ink set filled.
 - Output port: [Ethernet] is recommended. 🗨️ "With output port set to [Ethernet]"(P. 83)
 - Available Printers: Select JFX600-2531 connected.
 - Printer: Enter a name as required.
- (3) Click [OK].
- A confirmation screen appears.
- (4) Click [Yes].
- Printer registration starts.



- For more information, refer to the RasterLink installation guide. <https://mimaki.com/download/software.html>

1.4 Ink Replacement Method

When Ink Near End is Displayed

Ink levels are low. We recommend replacing with new Ink bottle as soon as possible. Note that ink may run out during printing.

You can check which Ink bottle must be replaced in INK STATUS on touch panel.  "INK STATUS"(P. 107)



When Ink End is Displayed

The ink has run out. Replace with new Ink bottle.

Thoroughly read the following and make sure you understand its contents.

Ink and other liquids used with this machine



- Pay close attention to ventilation and be sure to wear safety glasses, gloves, and a mask when handling ink, maintenance liquid, waste ink, or other solutions used with the machine. Leaking ink may adhere to the skin or get into the eyes or mouth.



● Clear ink

The types of clear ink that can be used will vary depending on the ink type mounted. Note that only the following combinations can be used.

| Mounted ink type | Clear ink type |
|------------------|----------------|
| LUS150 ink | LH100 ink |

● Ink caps

The type of ink cap that can be used will vary depending on the ink type. Note that only the following combinations can be used.

| Ink type | Cap type |
|--|----------------|
| <ul style="list-style-type: none"> • LUS150 ink | <p>[Cap A]</p> |

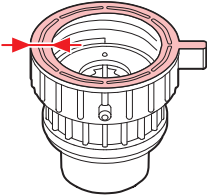
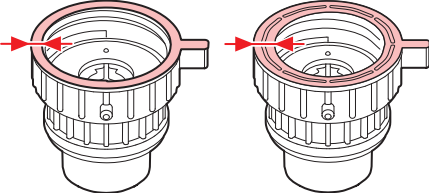
| Ink type | Cap type |
|---|--|
| <ul style="list-style-type: none"> • Primer ink • LUS120 ink • LH100 ink | <p>[Cap B]</p>  |
| <ul style="list-style-type: none"> • LUS150 ink • LH100 ink • Primer ink | <p>[Cap C]</p>  |

Replacing Ink

1

● Remove ink bottle

1 Rotate the lever on the tank section from left to right.

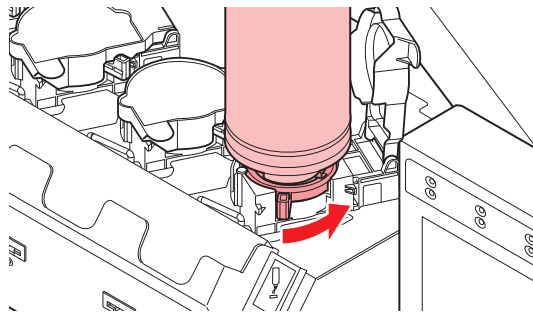

- Never attempt to rotate the ink bottles. Doing so may result in leaking ink.

2 Lift the ink bottles vertically.

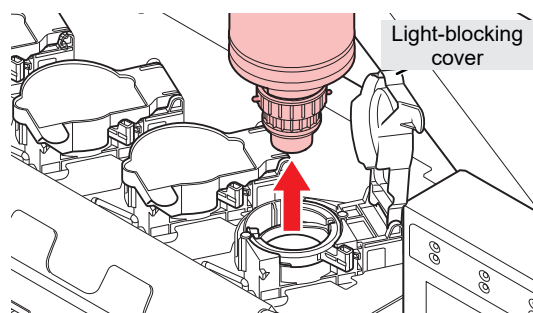

- Check to confirm that the light-blocking cover is closed when removing ink bottles. Close the light-blocking cover by hand if it is open. If the light-blocking cover is left open, the ink may harden, resulting in printer failure.
- Be careful to prevent ink leaks from the ink bottles.



- The O-rings fitted to the bottle caps may become detached when removing ink bottles. Refit the O-ring if it becomes detached.

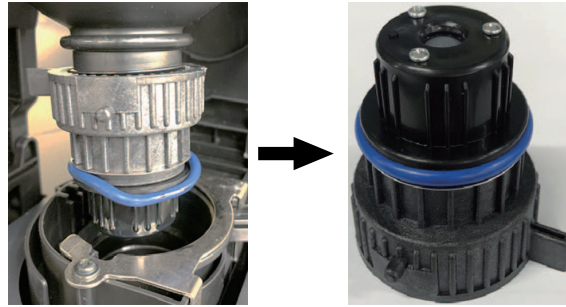

3 Soak up any ink droplets on the ink bottle caps.

- Use a wipe filter to soak up ink droplets and prevent dripping.

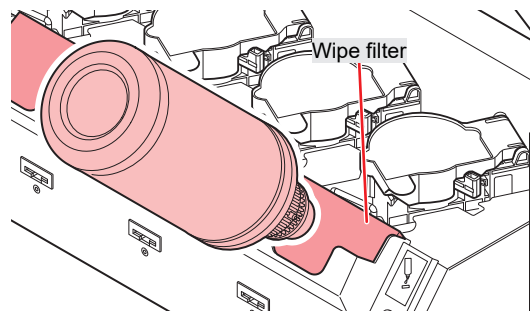

4 Wipe off any ink on the bottle caps with paper towel.



- Check to confirm that there is no foreign matter, such as non-woven fabric scraps or dust, adhering to the ink bottle caps. Continuing to use it when it is dirty may result in foreign matter blocking the ink channels, causing ink leakage.

5 Remove the bottle caps from the ink bottles.

- If the bottle caps are tight, remove using a tightening tool.

6 Remove the ink IC chip.

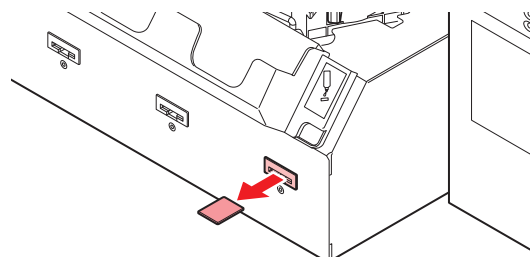

● Prepare ink bottle

1 Shake the ink bottle to the left and right slowly at least 20 times.

- Tighten the ink bottle lid securely, then shake the bottle slowly from left to right to ensure that the ink moves inside, holding the ink bottle lid with a piece of recommended non-woven fabric.

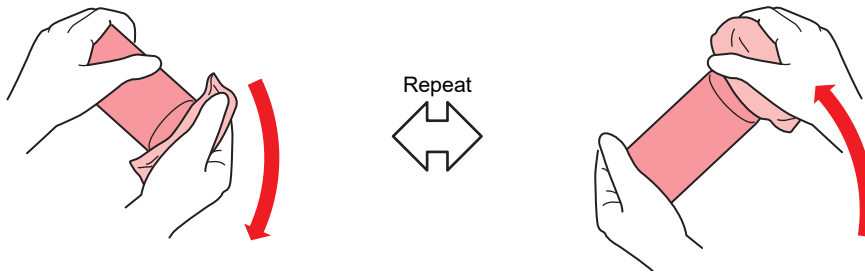

- Shake slowly. If the bottle is shaken too violently, ink may leak out or the air mixed in the ink may cause nozzle clogging.
- If the ink bottle is partially used, tilt it slowly until the ink bottle is upright.

2 Remove the ink bottle lid.

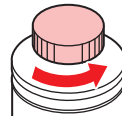

Important! If there is a seal covering the mouth of the ink bottle.

- Use a tool such as a cutting knife to cleanly cut out a circular piece of the seal. If any pieces of the seal are leftover, it may cause the ink to leak.

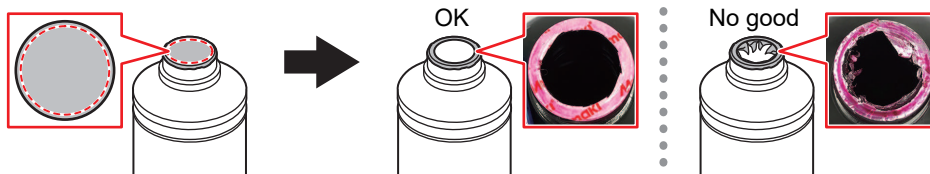

- Take care not to damage the mouth of the ink bottle. Any damage may result in ink leakage.
- Take care to prevent any pieces of the seal from dropping into the bottle. If a bottle that contains pieces of the seal is used, there is a risk that it will block the bottle cap and interrupt the supply of ink.

3 Attach the special cap to the ink bottle.

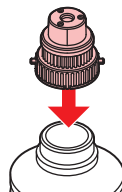



- Wipe off any ink or maintenance liquid remaining on the ink bottle or bottle cap. Otherwise there is a risk of ink leakage due to the bottle cap spinning freely.



- Check to confirm that there is no foreign matter, such as paper towel scraps or dust, adhering to the ink bottle caps. Continued use if soiled may result in foreign matter blocking the ink, causing ink leakage.

4 Use the tightening jig to tighten the bottle cap in place.

1

2

Tightening jig

| | | |
|--|---------------------|--------------------|
| <p>[SPA-0232]</p> <p>Position the upper arrow within this range!</p> | <p>Good example</p> | <p>Bad example</p> |
| <p>[SPA-0328]</p> <p>Position the upper arrow within this range!</p> | <p>Good example</p> | <p>Bad example</p> |



- Do not overtighten the bottle cap. Doing so may result in damage, leakage of ink, or cause it to spin freely. If the range indicated above is exceeded, loosen the bottle cap and then start again.
- Do not leave ink bottles with the ink bottle caps fitted for extended periods. Disregarding this precaution may result in the ink hardening.

5 Turn the ink bottle upside-down to check that no ink leaks occur.

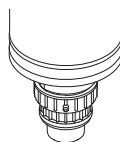

● SetInk bottle

The order of Ink bottle to be set depends on the ink set you are currently using. Check the ink slot numbers, then insert the correct color Ink bottle.

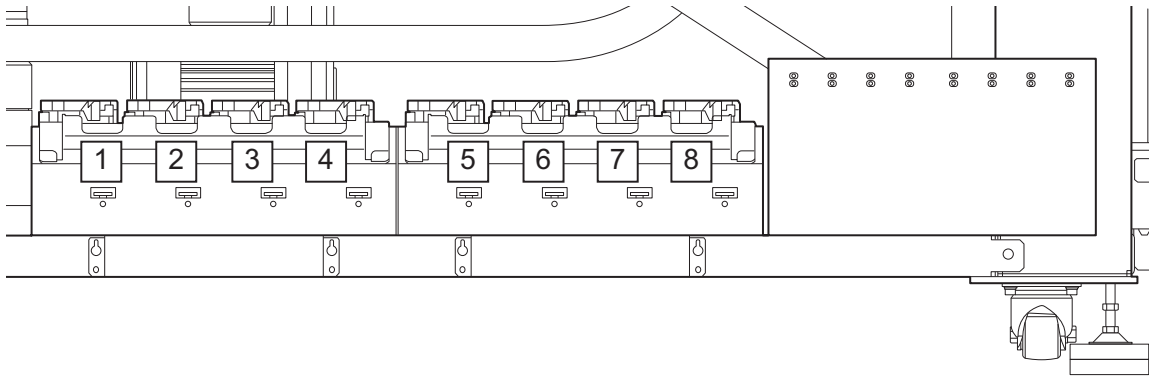

| Ink set | Ink distribution | | | | | | | |
|--------------------|------------------|---|----|---|---|---|----|----|
| | 1 | 2 | 3 | 4 | 5 | 6 | 7 | 8 |
| 4-color, W, Cl, Pr | C | M | W | W | Y | K | Pr | Cl |
| 4-color, 2W, 2Cl | C | M | W | W | Y | K | Cl | Cl |
| 4-color | C | M | K | Y | Y | K | M | C |
| 6-color, 2W | C | M | W | W | Y | K | Lm | Lc |
| 6-color, W+Cl | C | M | Cl | W | Y | K | Lm | Lc |

1 Mount ink bottles in the tank.

- Rotate the lever on the tank section from the left to the right end, then mount the ink bottle.

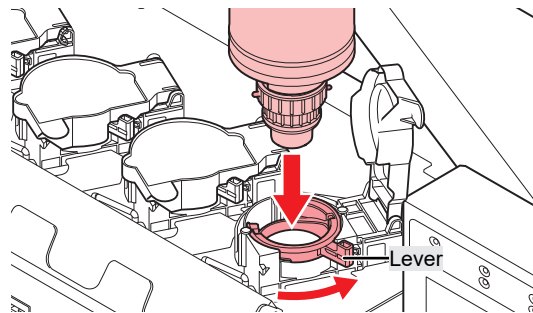

- You may apply the maintenance liquid onto the O-ring of the ink bottle caps so that the ink bottle can be inserted easily. Use the appropriate maintenance liquid to suit the ink being used.



2 Turn the tank lever from right to left to secure the bottle.



- Never attempt to rotate the ink bottles. Doing so may result in leaking ink.



- Once the ink bottle is mounted, use up the ink as quickly as possible.

3 Insert a new ink IC chip into the slot on the ink supply unit.

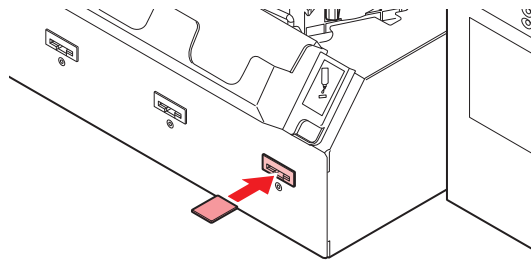

- Insert the ink IC chip with the metal side facing up. Inserting it in the wrong way may cause failure of the machine or damage the ink IC chip.



- Do not touch the metal parts of the ink IC chip. Static electricity may damage the ink IC chip, and dirt or damage may cause the ink IC chip read error.

• Ink IC chips

The marking on the ink IC chip indicates the color information.

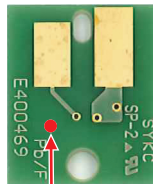

Marking locatio

| Ink color | Marking |
|---------------|---------------------------|
| Cyan | ● (One blue circle) |
| Magenta | ● (One red circle) |
| Yellow | ● (One yellow circle) |
| Black | ● (One black circle) |
| Light cyan | ●● (Two blue circles) |
| Light magenta | ●● (Two red circles) |
| White | ○ (One white circle) |
| Clear | ○○ (Two white circles) |
| Primer | ○○○ (Three white circles) |



- Insert the ink IC chip included in the package with the ink. The ink IC chip stores information such as the ink color, remaining amount, and expiration date. Printing is not possible if an incorrect ink IC chip is inserted.



- Removing and inserting ink IC chips may result in the display of a SYSTEM ALARM message. Clear the alarm if printing is not possible after inserting a new ink IC chip. 🧠 "Clearing Alarms"(P. 109)

Chapter 2 Printing



This chapter

This chapter describes printing procedures and settings.

| | | | |
|---------------------------------------|----|--|----|
| Print Process | 52 | Head Cleaning..... | 78 |
| Using the toggle print function..... | 55 | Correcting the Dot Position | 80 |
| Setting the toggle print mode | 56 | Feed Correction..... | 81 |
| Setting the default print area | 57 | Preparing a Job (RIP Data)..... | 83 |
| Loading the Media | 59 | With output port set to [Ethernet] | 83 |
| Media | 59 | With output port set to [File]..... | 87 |
| Load the media. | 60 | Printing | 90 |
| Setting the Media Origin..... | 65 | Repositioning the UV-LED Unit..... | 90 |
| Registering the Media Thickness | 70 | UV-LED Assistance Scan | 91 |
| Measuring Automatically | 70 | Starting Printing | 92 |
| Entering Values Manually | 71 | Stopping Printing..... | 97 |
| Setting the Head Gap..... | 73 | Moving the Y-Bar | 97 |
| Checking the Head Gap Value..... | 73 | Printing Using Nozzle Recovery | 98 |
| Test Printing | 74 | | |
| Checking Print Head Discharge..... | 74 | | |
| Checking White Ink Discharge..... | 75 | | |
| Ejection Failures..... | 77 | | |

2.1 Print Process

1. Setting Up RIP Software

 ["Installing the Mimaki Driver"\(P. 41\)](#) (required first time only)

 ["Installing RIP Software"\(P. 42\)](#) (required first time only)

Obtaining Color Profiles

 ["Setting up an Ethernet connection"\(P. 38\)](#) (required first time only)

2. Set up the control PC and RIP PC on the same local network.

 ["Connecting to a Local Network"\(P. 36\)](#) (required first time only)

- If the system is not connected to a local network, you can use a removable disk to store jobs (RIP data) in MPC. ["With output port set to \[File\]"\(P. 87\)](#)

3. Set the toggle print function.

 ["Using the toggle print function"\(P. 55\)](#)

4. Load the media.

☞ "Loading the Media"(P. 59)

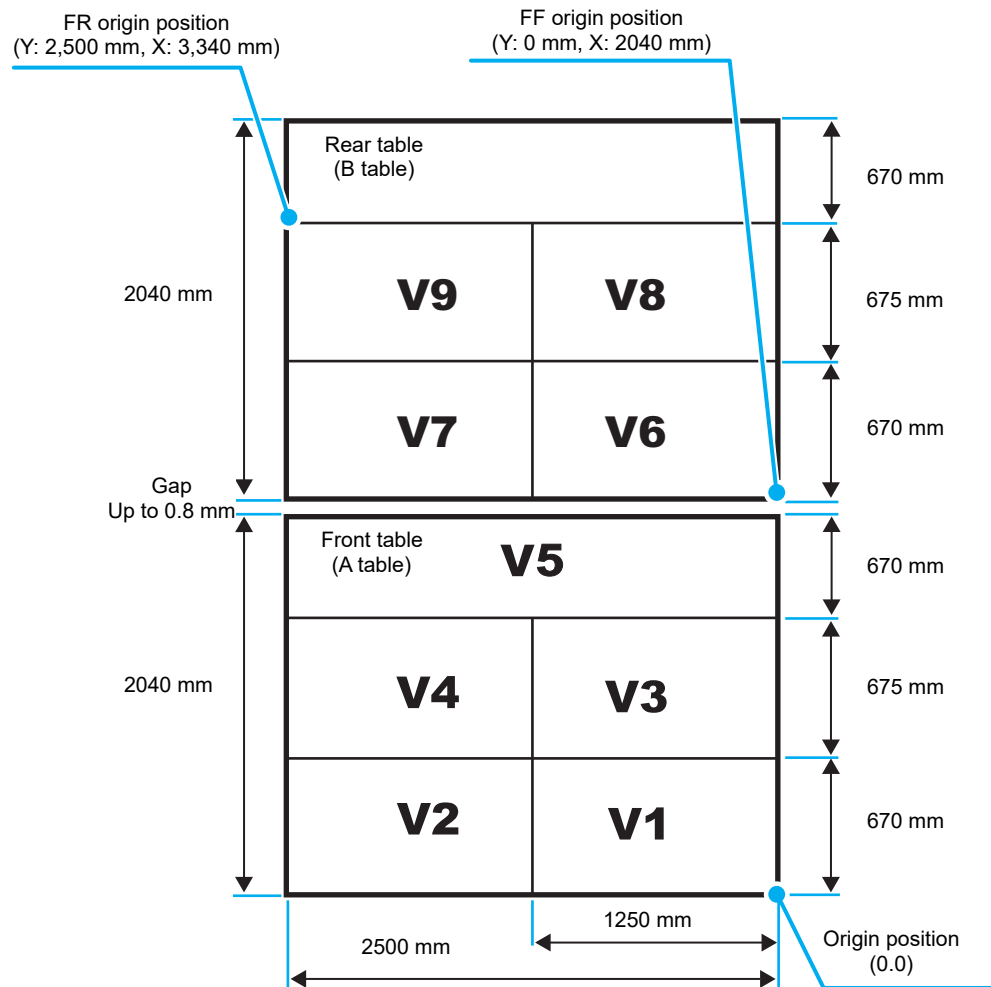

5. Register the media thickness.

☞ "Registering the Media Thickness"(P. 70)

6. Setting the Head Gap

☞ "Setting the Head Gap"(P. 73)

7. Check the state of the print head nozzles.

☞ "Test Printing"(P. 74)

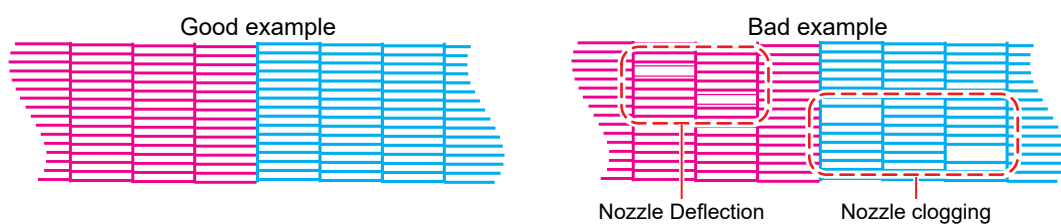

8. Clean the head to clear malfunctioning nozzles.

 "Head Cleaning"(P. 78)

9. Adjust the dot position for bi-directional printing.

 "Correcting the Dot Position"(P. 80)

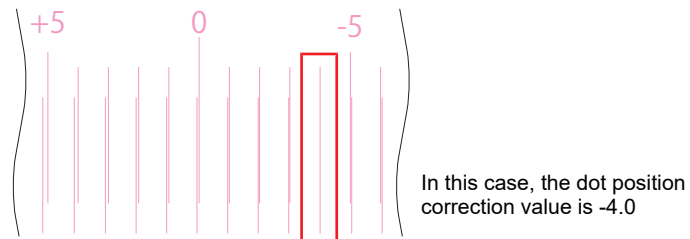

10. Import the job (RIP data) into MPC.

 "Preparing a Job (RIP Data)"(P. 83)

11. Print the job (RIP data).

 "Printing"(P. 90)

2.2 Using the toggle print function

The print area can be split into two sections, allowing the area to be toggled for each print. This enables the media to be positioned for one area while the other area is being printed, reducing the time taken for setting up the media.

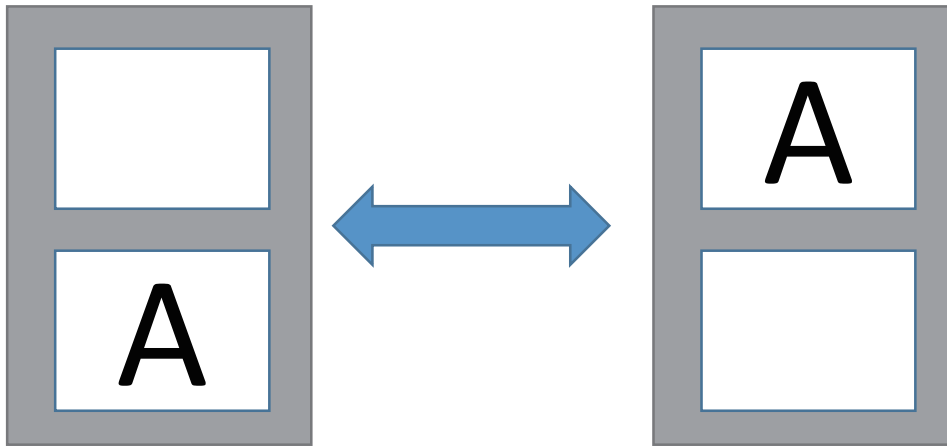

Position media in rear area while printing front area

Position media in front area while printing rear area

Important!

- The allowable print size changes when the toggle print function is enabled.

| | Toggle print function | |
|-----------------------|-----------------------|---|
| | OFF | ON |
| Maximum printing size | 2,500 mm × 3,100 mm | <ul style="list-style-type: none"> Front area 2,500 mm × 1,300 mm Rear area 2,500 mm × 1,300 mm |

Toggle print function disabled

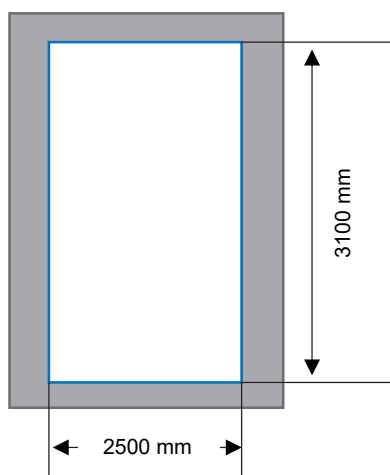

Toggle print function enabled

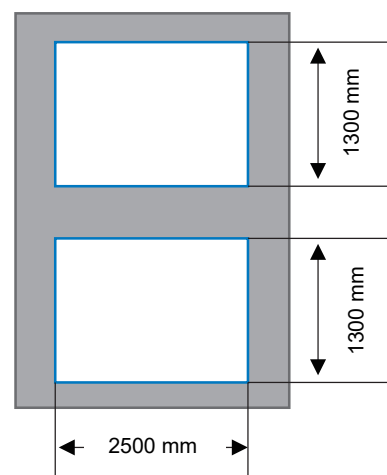

Toggle printing can be performed using either of the following two methods:

| Type | Toggle print function |
|------------------|---|
| FF origin method | This method is used to swap the media and check the print results for both the front and rear areas from the front of the table. It allows the media to be positioned more efficiently when printing is performed by only one person. |
| FR origin method | This method is used to swap the media and check the print results for the rear area from the rear of the table. It allows the media to be positioned more efficiently when printing is performed by two people or when printing on small-sized media. |

● FF origin method

| Position | Area | |
|------------------------|-------|---|
| Print origin | Front | Front right of front area |
| | Rear | Front right of rear area |
| Media setting position | Front | Position the media using the media guide hole at the front right of the front area. |
| | Rear | Position the media using the media guide hole at the front right of the rear area. |

● FR origin method

| Position | Area | |
|------------------------|-------|---|
| Print origin | Front | Front right of front area |
| | Rear | Rear left of rear area |
| Media setting position | Front | Position the media using the media guide hole at the front right of the front area. |
| | Rear | Position the media using the media guide hole at the rear left of the rear area. |

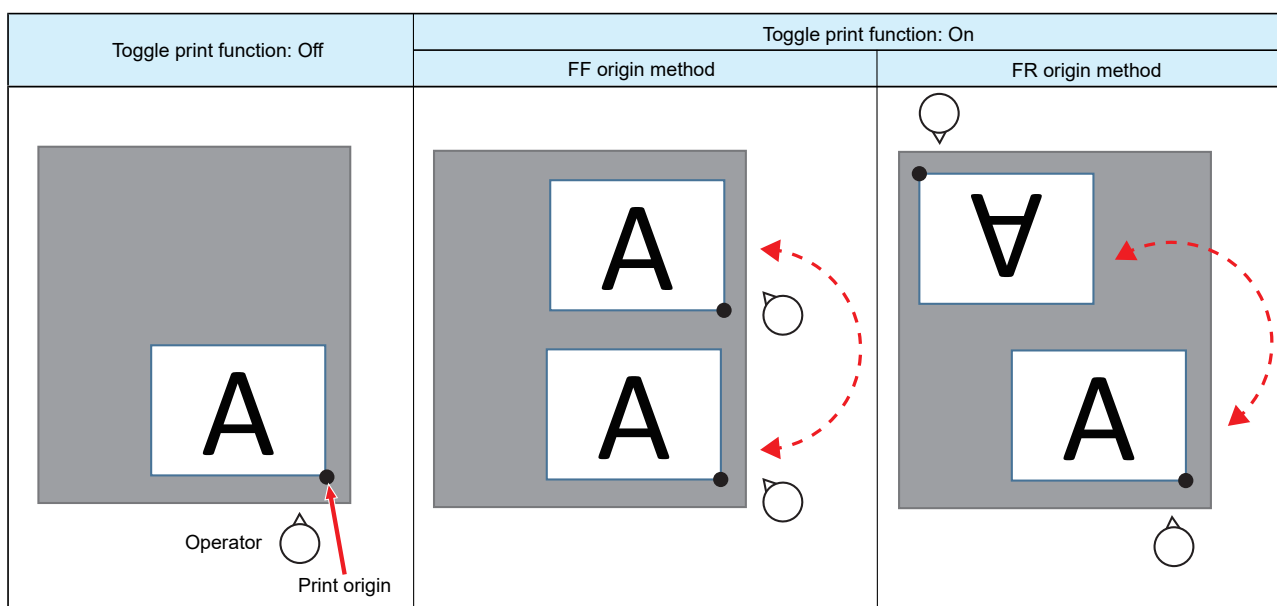

Setting the toggle print mode

- From MENU on the touch panel, tap [SETTING 2].
 - The Setup menu is displayed.

2 Tap [Toggle print] > [Mode].

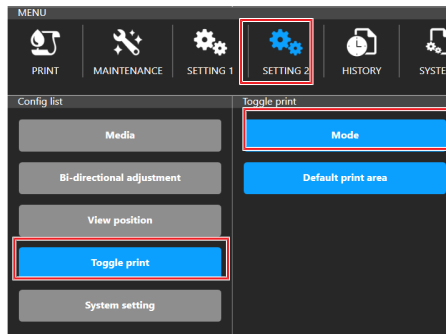

3 Select the mode, then tap [SET].

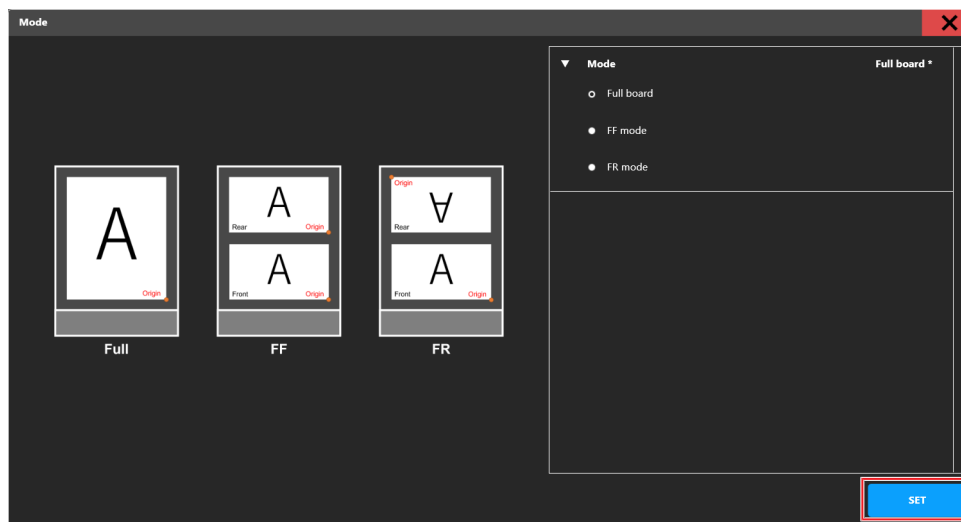

| Mode | Overview |
|------------|--|
| Full board | <ul style="list-style-type: none"> Disables the toggle print function. Prints combining the two tables as a single table. |
| FF mode | <ul style="list-style-type: none"> Prints by specifying the front or rear table for each job. The print origins are at the front right for both tables. |
| FR mode | <ul style="list-style-type: none"> Prints by specifying the front or rear table for each job. The print origin positions differ for each table. <ul style="list-style-type: none"> Front table: Front right of table Rear table: Rear left of table |

Setting the default print area

This setting is used for the following functions:

- Default value used for [PRINT AREA] when displaying the print conditions screen.
- Setting used for [PRINT AREA] when printing via a hot folder.

About [PRINT AREA] P. 94

1 From MENU on the touch panel, tap [SETTING 2].

2 Tap [Toggle print] > [Default print area].

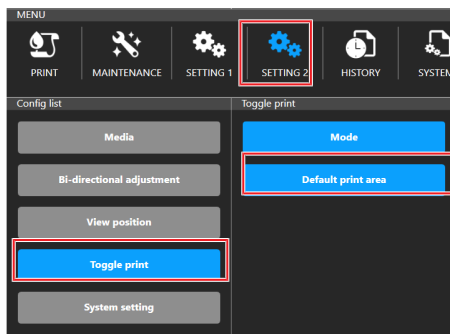

3 Select the print area, then tap [SET].

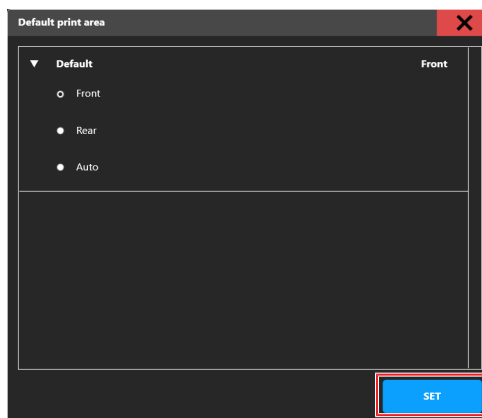

2.3 Loading the Media

Media

● Media handling precautions



- Use Mimaki-approved media to ensure consistent high-quality printing.

NOTICE



- Protect media from dust when stored. Otherwise print quality may be reduced.
- When storing standard-size media rolled up, store with the coated surface facing out.
- Static electricity countermeasures (such as ionizers, anti-static bars, water mist humidification, and alcohol-based anti-static agents) should be provided for the media. Do not use anti-static agents that contain surfactants.



- Do not leave media loaded in the machine. This may cause dust to collect on media. Also, do not use media after wiping off dust. The static electricity generated by wiping may impair print quality.
- Do not use media immediately after removing from the packaging. The media may expand or shrink depending on the ambient temperature and humidity at the storage location. Allow to sit for at least 30 minutes in the same room conditions as this machine before loading.
- Do not use curled media. Suction cannot be used on board media in particular with curled edges. Doing so may result in damage to the print head and impaired print quality. When using thin media, secure it around the edge using tape and check that the media is not curled before printing.
- When using large size media, perform a test print beforehand to confirm that no problems arise. The table suction area is made up of multiple plates. Factors such as the media thickness and stiffness may cause printing quality to be affected at the joins of the table suction area. The same applies to the vacuum holes.



- Media with uneven surfaces are more reflective than flat media. To reduce reflected light from sources other than the media, reduce unevenness as much as possible by loading unneeded media (thinner than the media used for printing) on the suction surface of the table even where no media is loaded.

Load the media.

Supported Media Thickness

0.0 mm to 60.0 mm (default value 0.0 mm)



- Be careful to avoid dropping heavy media on the table. Disregarding this precaution may impair the precision of the table surface and affect print quality.

1 Load the media on the table.

- Use the positioning pin as a guide when loading media.  ["Using the Positioning Tools"\(P. 63\)](#)



- Use adhesive tape or similar to hold down curled media edges against the table surface.
- To increase media suction, load unneeded media (thinner than the media for printing) against the suction on the table where no media is loaded.
- If the media lifts up near the edge of the table, attach thin tape on the edge.



- Load media to avoid concentrating weight (up to 50 kg per m²) in one location.

2 Open the suction valves needed for the size of the media used.

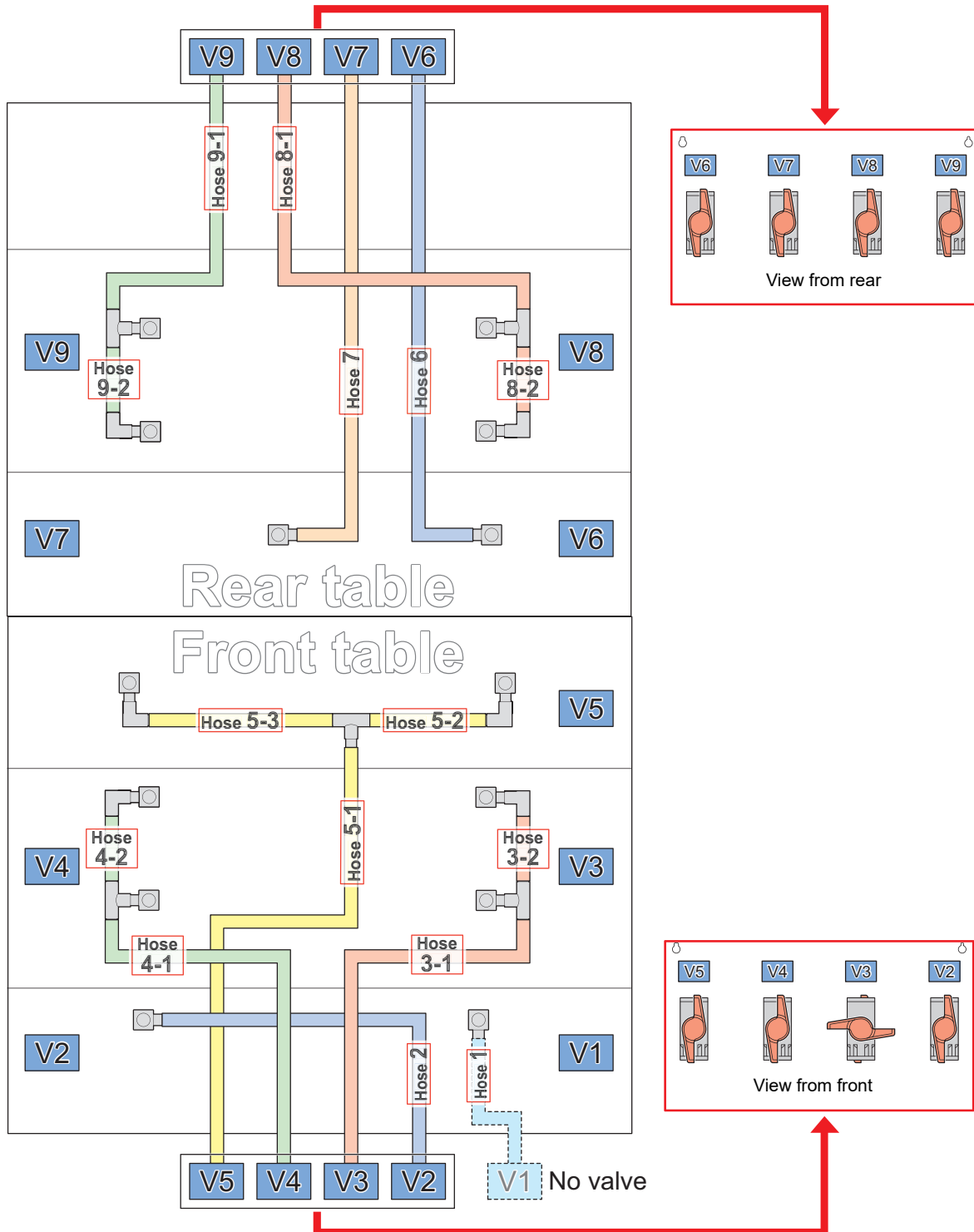



- For more information on the suction area, see below.

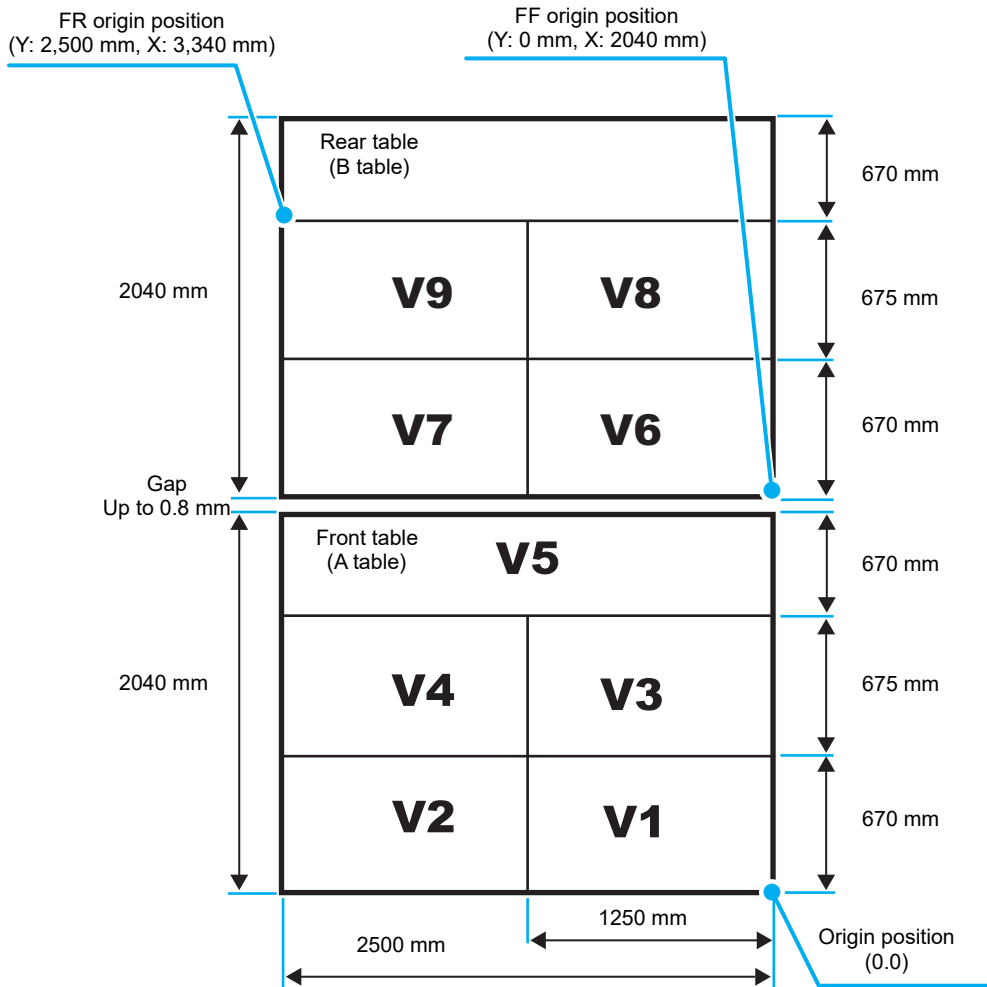

3 From QUICK MENU on the touch panel, tap [Vacuum] or step on the foot switch to apply suction to the media.



- Be sure to remove the positioning pin (or commercially available screw) if it protrudes past the media once the media is in place. The print head may come into contact with the pin/screw.

● **Operating the vacuum using the MPC**

1 From QUICK MENU on the touch panel, tap [Vacuum].

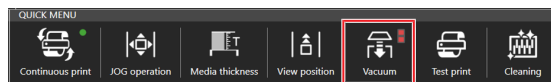

2 Tap the button corresponding to the range for which the vacuum is to be operated.

- The vacuum turns on or off for the range selected.
- When [Full] is selected, the vacuum turns on or off according to the current operating status.

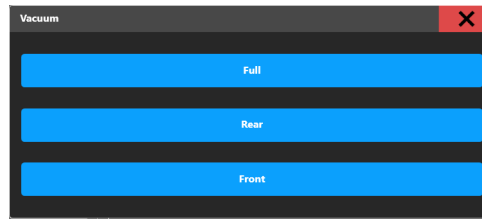

| Vacuum operating status | Vacuum operation after selecting [Full] |
|-------------------------|---|
| All areas off | All areas on |
| One table on | All areas off |
| All areas on | All areas off |

● About the status

The status for each table is indicated to the upper right of the [Vacuum] icon in QUICK MENU.

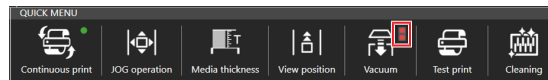

| Icon | Vacuum area |
|------|---------------|
| | All areas off |
| | Front |
| | Rear |
| | All areas on |

Using the Positioning Tools

The following accessories are provided to allow the media to be loaded straight.

- (1) Positioning pins (×10)
- (2) Origin stickers (×8)

● Using the positioning pins

Guide holes are provided on the table surface for inserting the positioning pins. Attach the included positioning pin to adjust the position at which media is loaded.

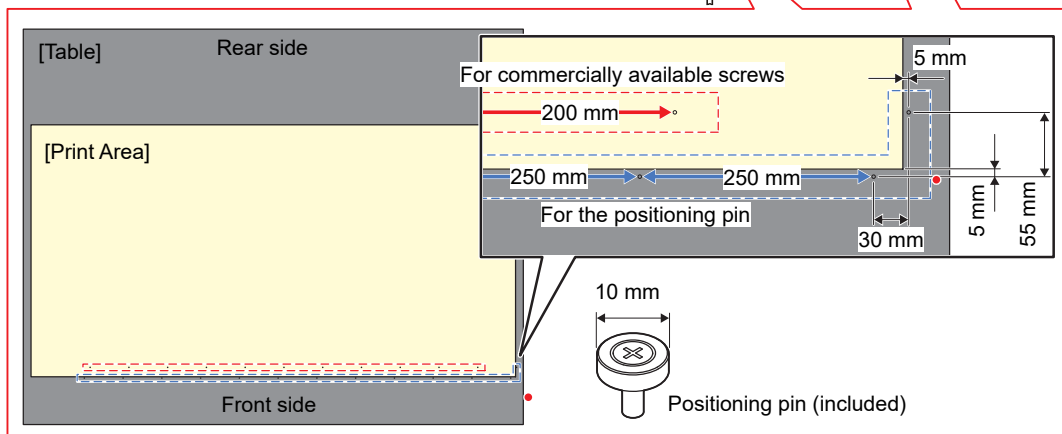
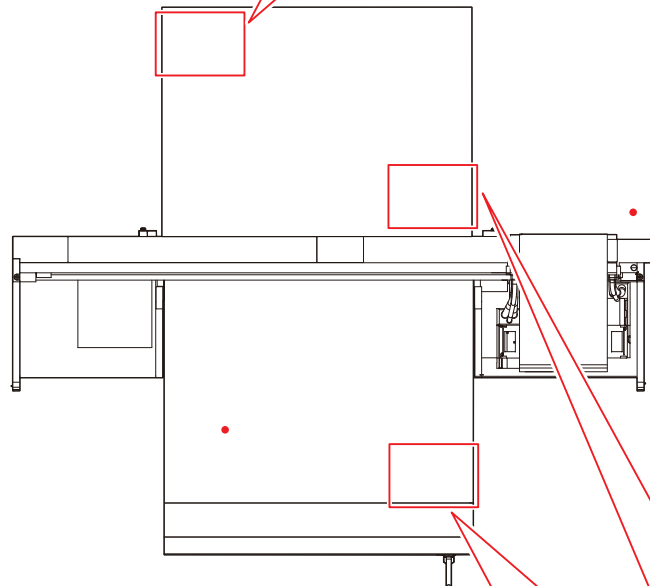
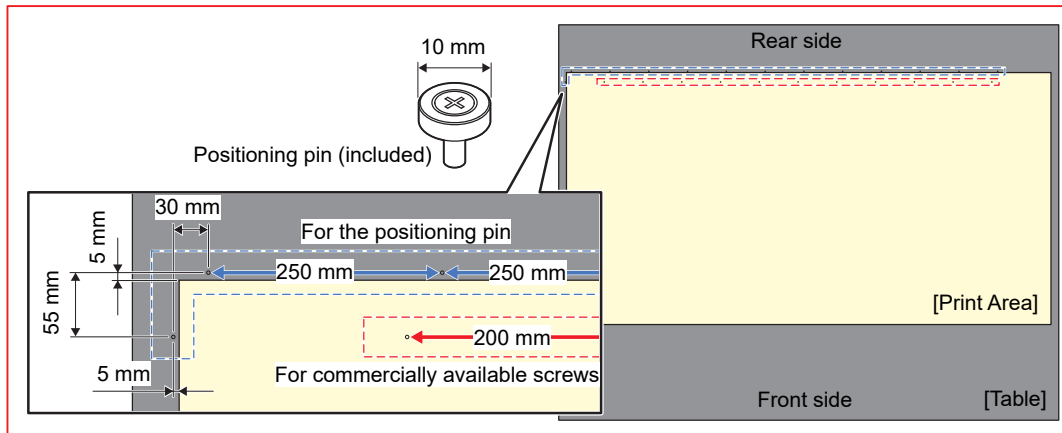

- You can use a commercially available M3 screw in place of the positioning pin provided.

● Using the origin stickers

The origin stickers can be used at positions on the table where you wish to load the media. The origin stickers are useful when using thin media. Affix the origin stickers at the corners of the media as required for loading the media.

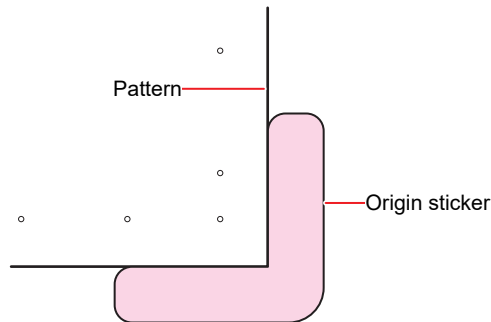

Setting the Media Origin

Set the media origin according to the individual toggle print mode.

Change the origin as follows:

| Item |
|--|
| Check visually as you set the origin. "Visually Setting the Origin"(P. 65) |
| Enter a value to set the origin. "Entering a Value to Set the Origin"(P. 68) |

Visually Setting the Origin

1 From QUICK MENU on the touch panel, tap [JOG Operation].

- A dialog box appears.



- You can also visualize this as follows:
 - (1) From MENU on the touch panel, tap [SETTING 2].
 - (2) Tap [Media] > [JOG operation].

2 Tap [Start].





- The carriage moves to the specified media origin, and the JOG operation screen is activated.

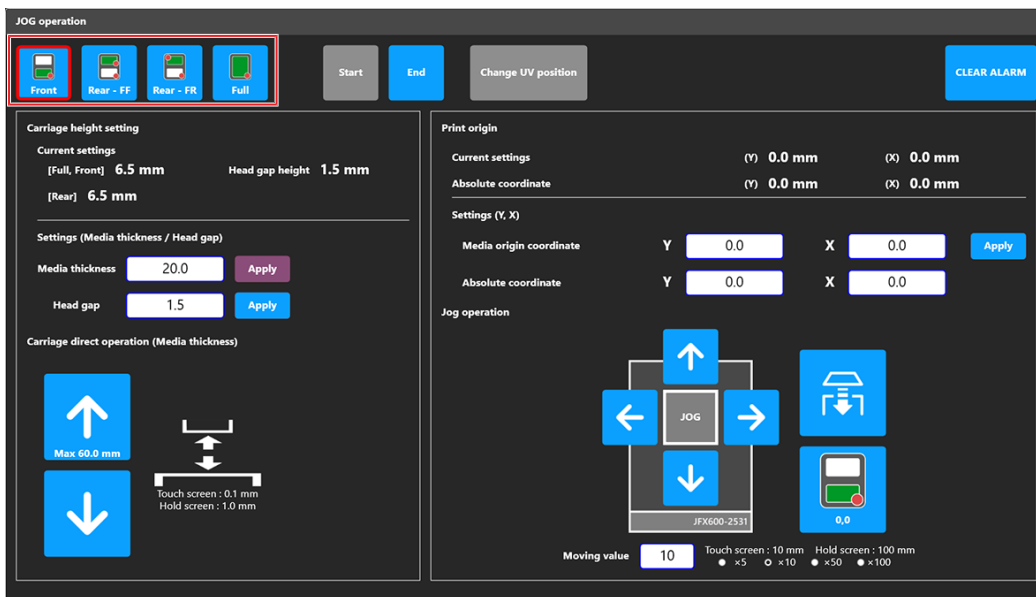

3 Tap the mode button for the required toggle print mode.

- Select the media origin type to be set.



| Mode | Print method |
|---|--|
|  Front | Printing on front table <ul style="list-style-type: none"> • FF mode • FR mode |
|  Rear - FF | Printing on rear table with FF mode |
|  Rear - FR | Printing on rear table with FR mode |
|  Full board | Printing on full board |

4 Move the LED pointer to the preferred position.

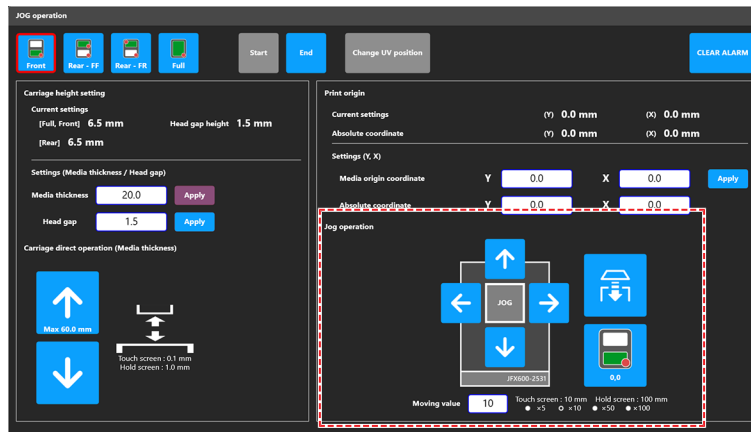

- You can change the origin by entering a value.

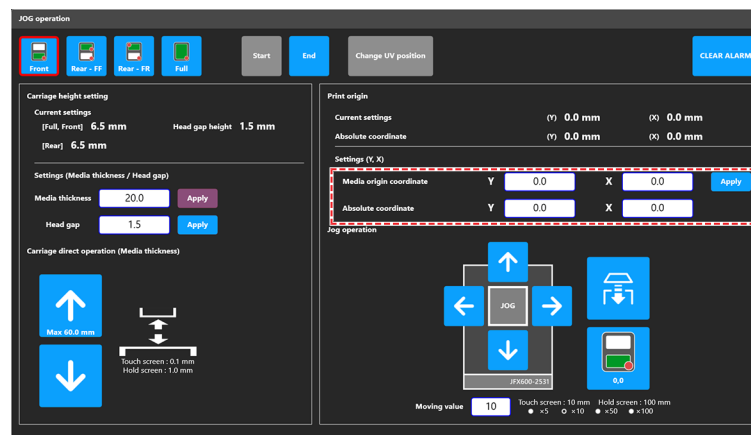

2

5 Tap [Apply] after the screen indicates the measured value.

- The measured value is applied to the mode selected.
- To continue and set a different mode, repeat from Step 3.

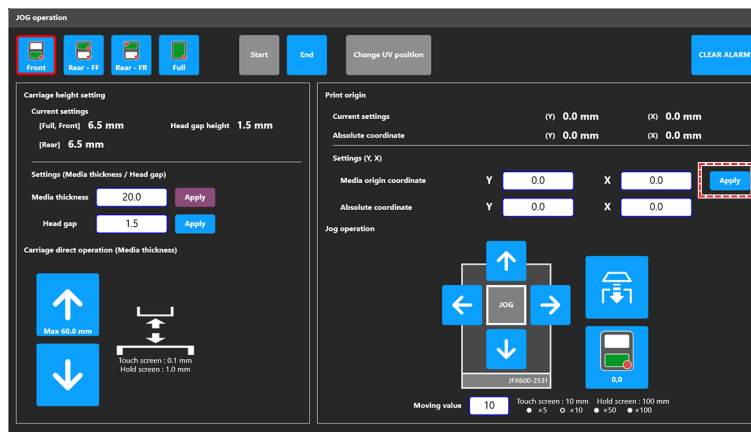

6 Tap [End].

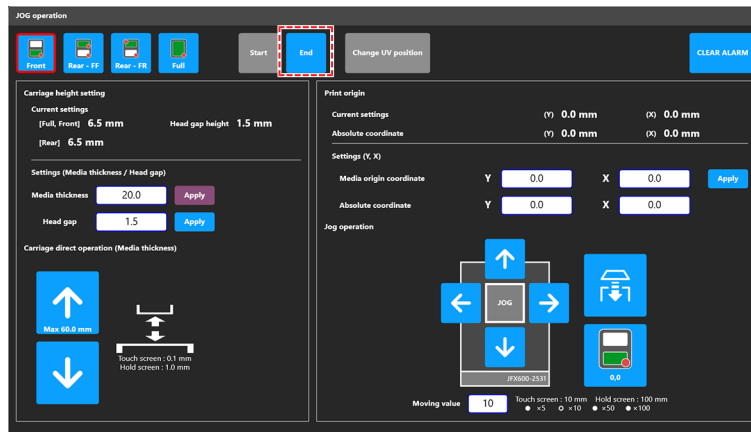

7 Tap [X] in the upper right to close the dialog box.

Entering a Value to Set the Origin

- 1 From MENU on the touch panel, tap [SETTING 2].
- 2 Tap [Media] > [Media origin].
 - A dialog box appears.
- 3 Enter the origin for the toggle print mode.
 - Tap [-] / [+] to enter the value.

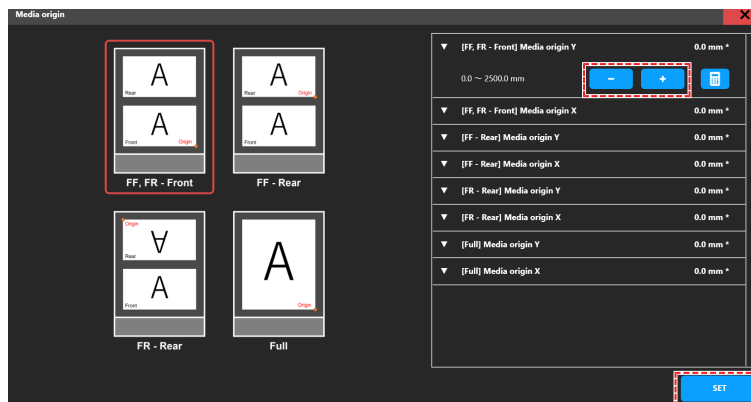

- Use the [Numeric keypad] to enter your specified value.

- (1) Tap .
 - A dialog box appears.





- (2) Enter the preferred value, then tap [Enter].

4 Tap [SET].

2.4 Registering the Media Thickness

Set media thickness as follows:

| Item |
|--|
| Automatically register media thickness.  "Measuring Automatically"(P. 70) |
| Manually register media thickness.  "Entering Values Manually"(P. 71) |

Measuring Automatically

Check beforehand

- Is media loaded?  "Loading the Media"(P. 59)

1 From QUICK MENU on the touch panel, tap [Measure media thickness].

- A dialog box appears.



- You can also visualize this as follows:
 - (1) From MENU on the touch panel, tap [SETTING 2].
 - (2) Tap [Media] > [Measure media thickness].

2 Tap [Start].

- The carriage will move over the table and the [Measure media thickness] screen will be activated.

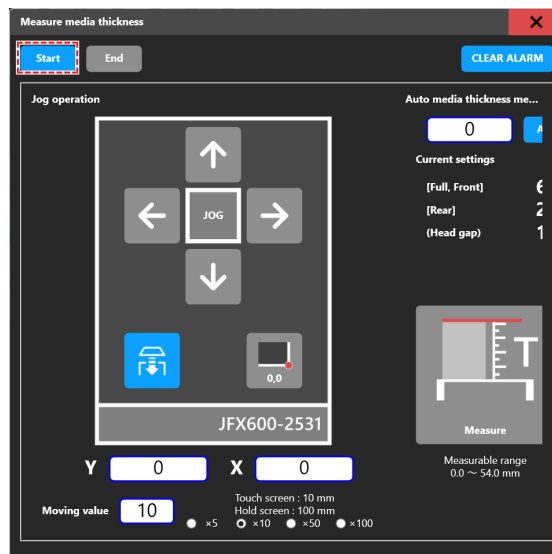

- 3 Move the carriage to the position of the media and tap [Measure].
 - After performing the measurement, a measured value confirmation dialog will appear.

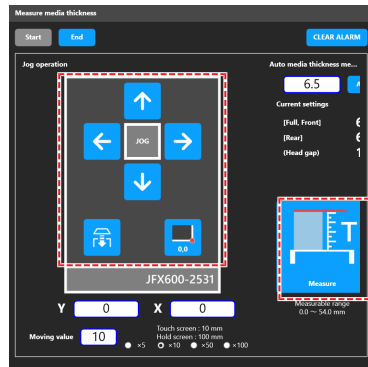

- 4 Tap [Yes].

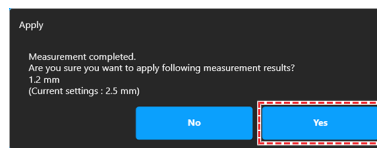

- There may be a measurement error of about ± 0.1 mm.

- 5 Select the thickness setting corresponding to the toggle print mode.

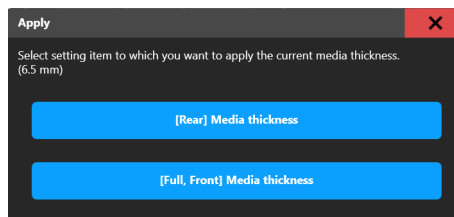

- 6 Tap [End].

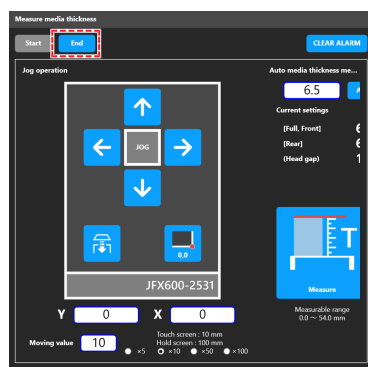

- 7 Tap [X] in the upper right to close the dialog box.

Entering Values Manually

- 1 Check (or measure) the media thickness.

- 2 From MENU on the touch panel, tap [SETTING 2].
- 3 Tap [Media] > [Media thickness / Head gap].
 - A dialog box appears.
- 4 Enter the media thickness for the thickness setting corresponding to the toggle print mode.
 - Tap [-] / [+] to enter the value.

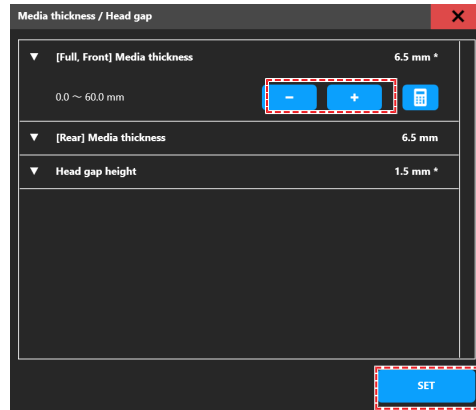

- Use the [Numeric keypad] to enter your specified value.

(1) Tap .

- A dialog box appears.



(2) Enter the preferred value, then tap [Enter].

5 Tap [SET].

2.5 Setting the Head Gap

Set the height from the media to the print head nozzle surface.



- Use 1.5 mm as the head gap. With inkjet printers, if the gap between the print and media increases, the ink droplets may vaporize before they reach the media. Vaporized ink will adhere to the print head nozzle surface, media, and cooling fan filter. The amount of reflected light on the print head surface also increases. Reflected light may cure vaporized ink adhering to the nozzle surface or increase ink viscosity, which may reduce print quality and cause print head failures.

(1) To block reflections when printing on media with an uneven surface, cover the suction areas on the table.

- Be careful to avoid touching the carriage or Y-bar.

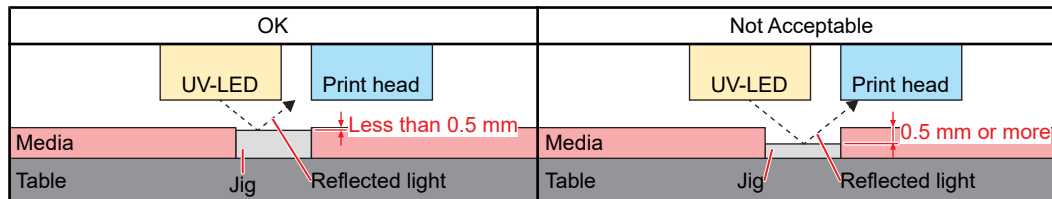

(2) When printing on flying discs or other curved media, cover the curved surface. UV-LED light may scatter widely off curved surfaces.

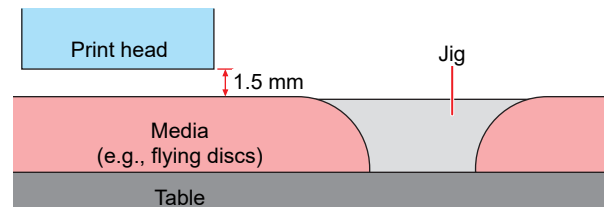

1 From MENU on the touch panel, tap [SETTING 2].

2 Tap [Media] > [Media thickness / Head gap].

3 Enter the head gap value.

- Setting value: 1.5 to 3.0 mm



- The maximum head gap value varies depending on the media thickness setting.

4 Tap [SET].

Checking the Head Gap Value

1 From MENU on the touch panel, tap [SETTING 2].

2 Tap [Media].

- The head gap value is displayed.

2.6 Test Printing

Print a test pattern to confirm that the ink prints correctly. Perform head cleaning if you observe any ejection failures (e.g., nozzle clogging or deflection). 🖱️ "Head Cleaning"(P. 78)

Check beforehand

- Is media loaded? 🖱️ "Loading the Media"(P. 59)
- Did you set the media thickness? 🖱️ "Registering the Media Thickness"(P. 70)
- Did you set the head gap? 🖱️ "Setting the Head Gap"(P. 73)



- Load media at least 500 mm wide. You cannot print the entire pattern if media less than 500 mm wide is used.



- The ink used in the machine is warmed before printing. Printing is disabled while the ink is warmed.

Checking Print Head Discharge

1 From QUICK MENU on the touch panel, tap [Test print].

- A dialog box appears.



- You can change the printing direction. 🖱️ "Printing Layout and Direction"(P. 75)

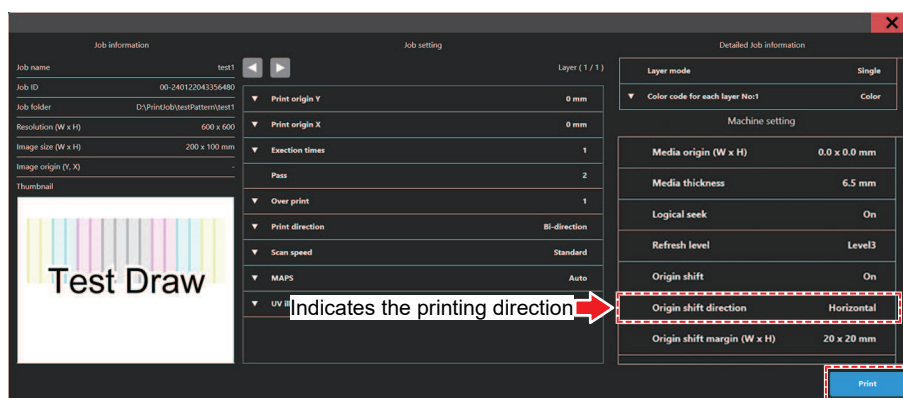

2 Tap [Print].

- Test printing starts.

3 Check the print results.

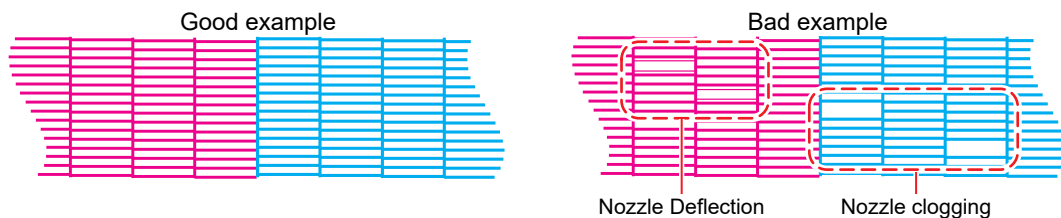

Printing Layout and Direction

You can change the printing layout and direction.

1 From MENU on the touch panel, tap [SETTING 1].

2 Tap [Internal pattern] > [Auto print origin shift].

- A dialog box appears.

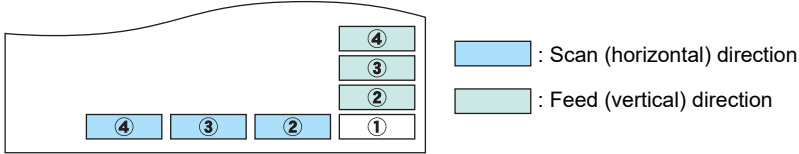
| | |
|---------------------|--|
| Internal pattern | Set the print position for printed patterns used in test printing or for correcting the dot position. |
| Origin shift | <ul style="list-style-type: none"> • Origin shift: Prints in the direction specified when set to ON. • Origin shift direction: Set the print direction.  |
| Origin shift margin | <ul style="list-style-type: none"> • Y margin: Sets the scan (horizontal) direction margin. • X margin: Sets the feed (vertical) direction margin. |
| Feed Comp. | Set the feed offset. |
| Feed offset value | Enter the feed offset value. |
| Feed offset pattern | Print the feed offset pattern. |

3 Tap [SET].

Checking White Ink Discharge

The following two methods are available for checking white ink:

- Print on clear film.
 -  "Checking Print Head Discharge"(P. 74)
- Print the background for the test pattern using black ink.
 - Print the background as follows:

1 From MENU on the touch panel, tap [PRINT].

2 Tap [[TEST PATTERN]] > [User] > [TestPattern].

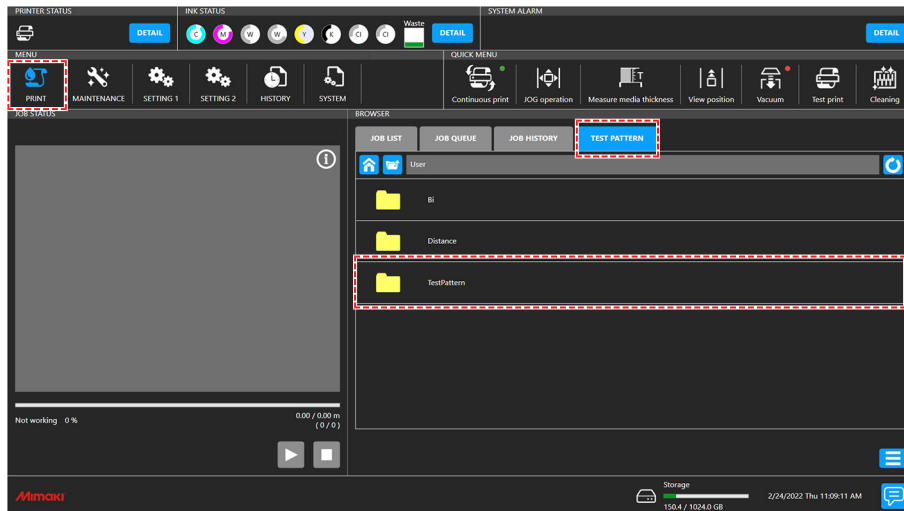

3 Select [TestDraw for SP check], then tap [Print].

- Test printing starts.
- The origin shift direction settings are fixed in the "Scan direction".

4 Check the print results.

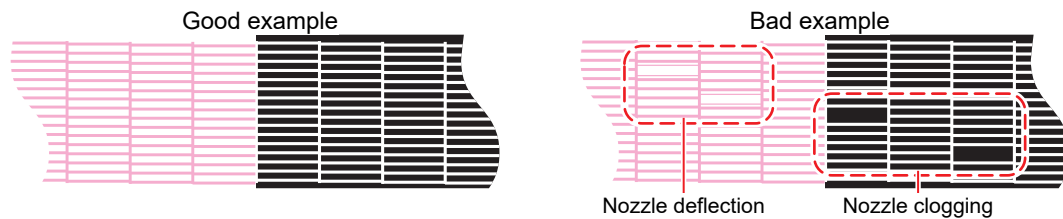

Ejection Failures

Typical examples of ejection failures (e.g., nozzle clogging, deflection) are as shown below. In order to prevent printing in such a state, check whether the ink has been properly ejected regularly before printing.

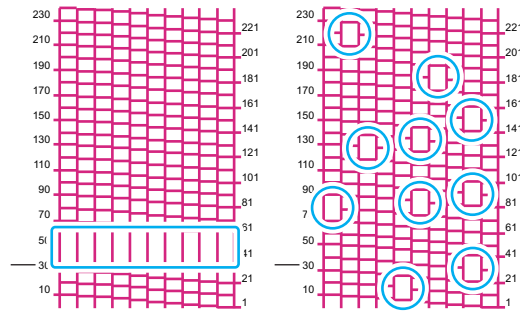
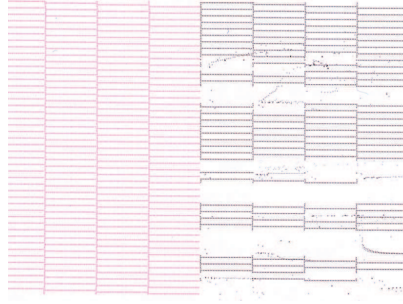
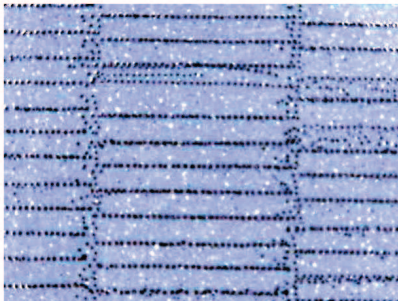

- The default values (recommended values) are set for auto maintenance to keep the print head in good condition. Altering the settings^{*1} may increase the risk of ejection failures (e.g., nozzle clogging or deflection). (*1: Such as decreasing the maintenance frequency)
If ejection failures occur even if the recommended values are used, alter the settings such as increasing the maintenance frequency.

2.7 Head Cleaning

The following head cleaning methods are available. Choose the method based on test results.

| Item | Details |
|--------|---|
| Soft | If the print shows a bent line (nozzle deflection) |
| Normal | If the print shows a missing line (nozzle clogging) |
| Hard | If soft cleaning and normal cleaning fail to resolve ejection failures (e.g., nozzle clogging or deflection). |



- Cleaning is not possible when [Ink End] is displayed. Replace with new ink. ["Ink Replacement Method"\(P. 44\)](#)

1 From QUICK MENU on the touch panel, tap [Cleaning].

- A dialog box appears.

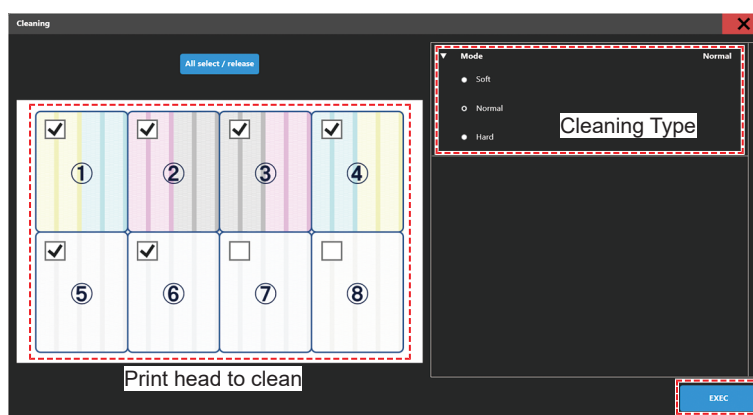

- You can also visualize this as follows:
 - (1) From MENU on the touch panel, tap [MAINTENANCE].
 - The Maintenance menu is displayed.
 - (2) Tap [Cleaning] > [Cleaning].

2 From MENU on the touch panel, tap [MAINTENANCE].

3 Select the type of cleaning.

4 Select the Head to clean.

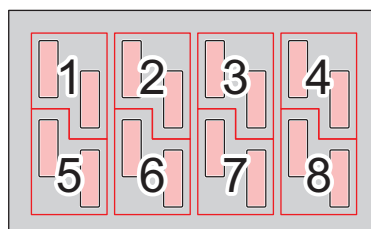

5 Tap [EXEC].

6 Run another test print and check the print results.

- Repeat the cleaning and test printing process until the print results appear normal.



- Do the following if head cleaning fails to resolve ejection failures such as nozzle clogging or deflection:

- ☞ "Wiper Cleaning"(P. 130)

- ☞ "Cap Rubber Cleaning"(P. 132)

- ☞ "Ink fillup (Print head)"(P. 155)

- ☞ "Cleaning the Print Head Nozzle Surface"(P. 156)

2.8 Correcting the Dot Position

Changing the media and print head height will also alter the dot positions. Correct the drop position to suit the type of media used. Image defects (e.g., overlaid lines or blurred images) will result if the drop position is not properly corrected.

Check beforehand

- Is media loaded?  ["Loading the Media"\(P. 59\)](#)
- Did you set the media thickness?  ["Registering the Media Thickness"\(P. 70\)](#)
- Did you set the head gap?  ["Setting the Head Gap"\(P. 73\)](#)



- Load media at least 500 mm wide. You cannot print the entire pattern if media less than 500 mm wide is used.



- The ink used in this machine is warmed before printing. Printing and cleaning are disabled while the ink is being warmed.

1 From MENU on the touch panel, tap [SETTING 2].

2 Tap [Bi-directional adjustment] > [**** **pattern].

- Select the resolution to adjust.



- The indicated resolutions are those in the scan direction.

3 Tap [EXEC].

4 Check the print results.

- A correction value input screen appears.
- Enter the position where the two upper and lower lines coincide.

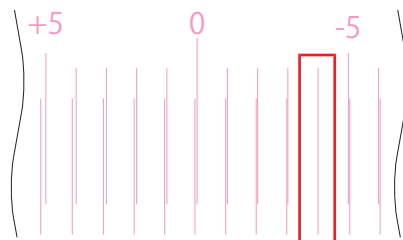

In this case, the dot position correction value is -4.0

5 Tap [Bi-directional adjustment] > [Adjust Bi-directional print].

6 Enter the correction value.

- Correction value: -40 to 40

7 Tap [EXEC].



- If the lines do not coincide when the correction value is within the range -40 to 40, the head gap may be inappropriate. Adjust the gap.  ["Setting the Head Gap"\(P. 73\)](#)

2.9 Feed Correction

Changing the feed correction value can correct the feed amount during printing.

Important!

- As the feed amount is adjusted during the manufacturing process, the feed correction value does not need to be changed from "0" normally. Use this function if there are significant image quality problems such as visible banding streaks between passes.
- If the feed correction value is changed from "0" and a forward printing^{*1} job is overlapped with a reverse printing^{*2} job with different job conditions (resolution, number of passes, or MAPS setting), the print positions may be offset. Be sure to use the same job conditions.

*1: The method of printing from the table front to the rear. Used for color, spot color, or color-to-spot color printing.

*2: The method of printing from the table rear to the front. Only used for spot color-to-color printing. (4C+4SP machine only)

Check beforehand

- Is media loaded?  ["Loading the Media"\(P. 59\)](#)
- Did you set the media thickness?  ["Registering the Media Thickness"\(P. 70\)](#)
- Did you set the head gap?  ["Setting the Head Gap"\(P. 73\)](#)



- Load media at least 500 mm wide. You cannot print the entire pattern if media less than 500 mm wide is used.

1 From MENU on the touch panel, tap [SETTING 1].

2 Tap [Feed Comp.] > [Feed offset pattern].

3 Tap [Print].

4 Check the print results.



- Determine the correction value based on the print results.

5 Tap [Feed Comp.] > [Feed offset].

6 Enter the correction value.

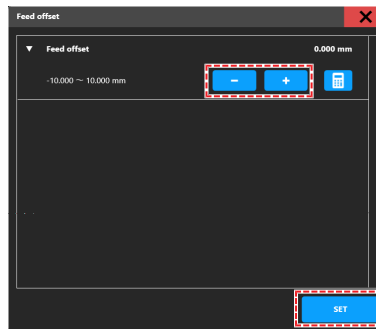

- Tap [-] / [+] to enter the value.
- Correction value: -10.000 mm to 10.000 mm



- Use the [Numeric keypad] to enter your specified value.

- (1) Tap .
 - A dialog box appears.

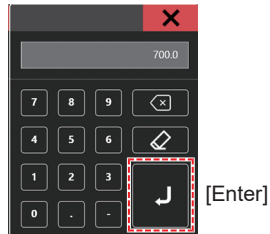

- (2) Enter the preferred value, then tap [Enter].

7 Tap [SET].

2.10 Preparing a Job (RIP Data)

The explanation here applies to MIMAKI RIP software (RasterLink). The method for importing jobs (RIP data) into the machine (control PC) differs depending on the output port settings (☞ ["Setting Up RIP Software"](#)(P. 42)) in the RasterLink printer settings.



- Prepare suitable image data for printing.

With output port set to [Ethernet]

Import jobs (RIP data) to the machine (control PC) using a local network. ☞ ["Connecting to a Local Network"](#)(P. 36)

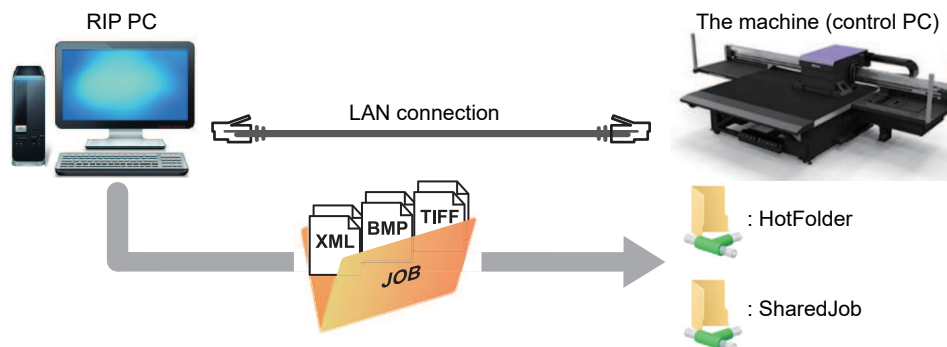

The shared folder for the machine (control PC) includes the following two types: These should be used as necessary, as the operation differs depending on the data saving destination.

| Item | Overview |
|-----------|--|
| SharedJob | <ul style="list-style-type: none"> • Saving data in [SharedJob] adds the jobs to the MPC job list. ☞ "When saved to [SharedJob]"(P. 85) <ul style="list-style-type: none"> – Jobs can be printed by selecting from the job list. |
| HotFolder | <ul style="list-style-type: none"> • Saving data in [HotFolder] starts printing immediately. ☞ "When saved to [HotFolder]"(P. 86) <ul style="list-style-type: none"> – Printing is not always started immediately, even if you save to [HotFolder]. |

Creating RIP Data

1 Launch RasterLink.

- Click the icon on the RIP PC desktop.



2 Select the shared folder from [Select output folder].

- SharedJob: To print from [JOB LIST] on the touch panel (Example: [*****\SharedJob])
- HotFolder: To print automatically (Example: [*****\HotFolder])

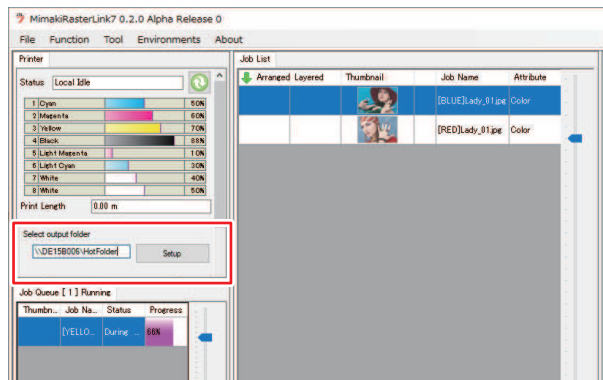

- Please change "*****" to the serial number of the printer.
- From MENU on the touch panel, tap [SYSTEM] > [System information] to display the serial number on the browser screen at right.

3 Select the image data to print.

- (1) Select [File] > [Open].
- (2) Select the desired image data, then click [Open].
 - If multiple printers are registered, select JFX600-2531 in "Printer Name".

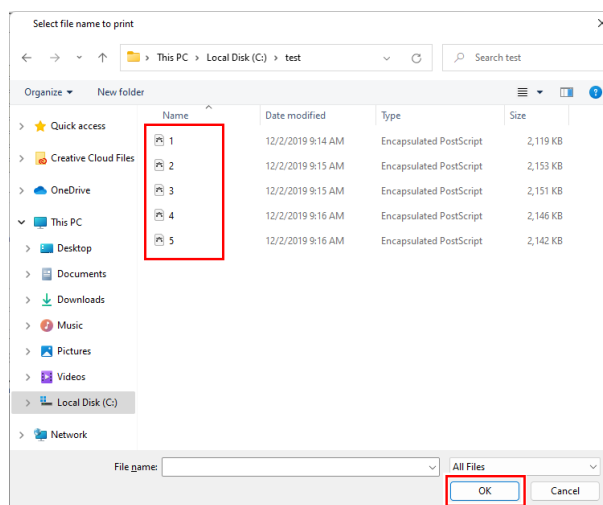

4 Select the image data imported.

- The image is displayed in the tab for JFX600-2531 selected in "Printer name".

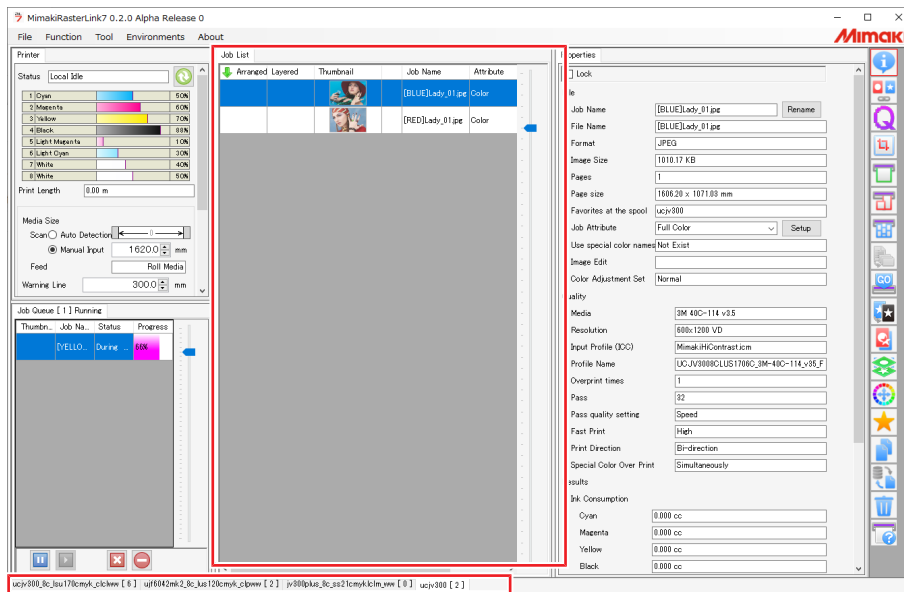

5 Check the settings and alter as necessary.

- Specify the following settings by clicking the function icons shown on the right-hand side of the screen:



(General Print): Specifies settings like enlargement/reduction and number of copies.





(Print Condition): Selects a color profile for the media and ink set loaded in the machine.



- For more information, refer to the RasterLink reference guide. <https://mimaki.com/download/software.html>

6 Prepare a job (RIP data) from image data.

- Click  (Execute) from the function icons on the right-hand side of the screen. Select "RIP and Print", then click [Start].
- When the output destination folder is [SharedJob]: The RIP job is added to the MPC job list.  "When saved to [SharedJob]"(P. 85)
- When the output destination folder is [HotFolder]: "Job receiving" is displayed in the lower-left corner of the MPC screen, and printing starts.  "When saved to [HotFolder]"(P. 86)



- When the output port is set to [Ethernet], the job is saved in the specified shared folder with the job name determined automatically by RasterLink.

When saved to [SharedJob]

Saving data in [SharedJob] adds the jobs to the MPC job list.

● Job checking procedure

Jobs that have been successfully loaded are saved in [SharedJob].

- From MENU on the touch panel, tap [PRINT] > [JOB LIST] > [SharedJob].

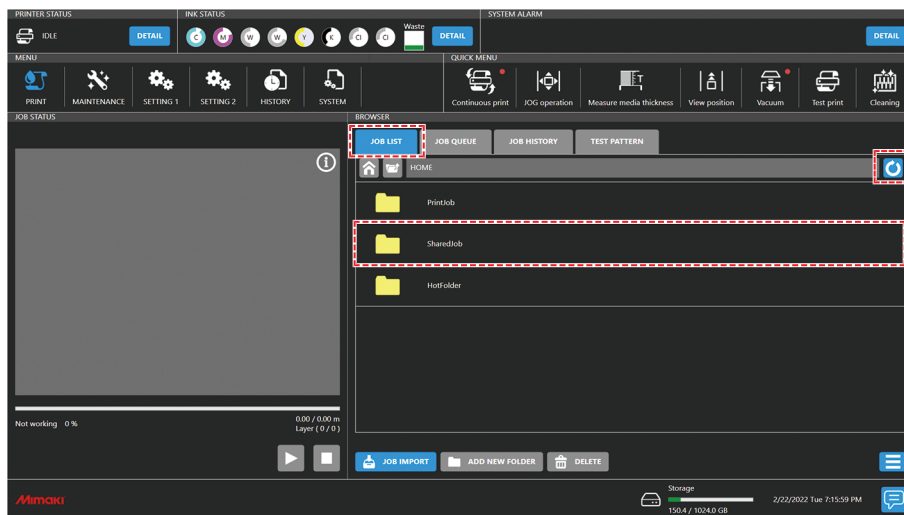

- If a job is not displayed, tap the refresh button.

When saved to [HotFolder]

Saving data in [HotFolder] starts printing immediately.

- [QUICK MENU] > [Continuous print] setting
 - When continuous print mode is on: Printing starts immediately.
 - When continuous print mode is off: The job is added to the queue. Please turn on continuous print mode to start printing.
- If another job is currently being printed
 - The job is added to the queue. Printing starts automatically when the other job print is complete. Please note that when automatic operation mode or work change mode are turned on, continuous print mode will turn off and printing will not start once the other job print is complete.

● Job checking procedure

Jobs that have been successfully loaded are saved to [HotFolder].

- From MENU on the touch panel, tap [PRINT] > [JOB LIST] > [HotFolder].

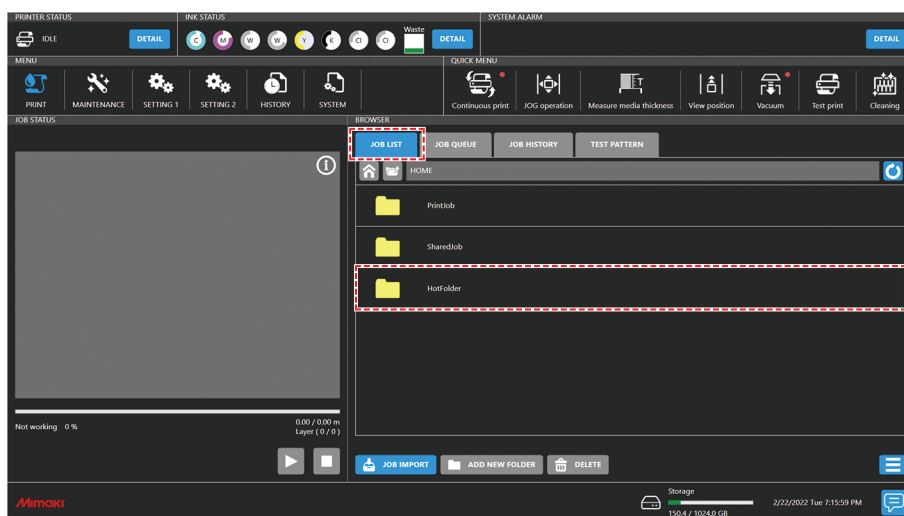



- Up to 100 jobs can be saved to [HotFolder] by default. If the number exceeds 100 jobs, the oldest jobs in the print history are deleted. The number of jobs that can be saved can be changed as follows:
 "Setting 2 Menu"(P. 122)[System setting] > [HotFolder setting]

Copying jobs to a shared folder at any time

Jobs can be created in advance on the RIP PC, and then copied to the shared folder at any time for importing to MPC.

- 1 Create a job on the RIP PC in advance.
- 2 Copy the job created on the RIP PC to the shared folder (SharedJob or HotFolder) to be used.
 - Enter [*****] in the Explorer address bar to open the shared folder of the machine.

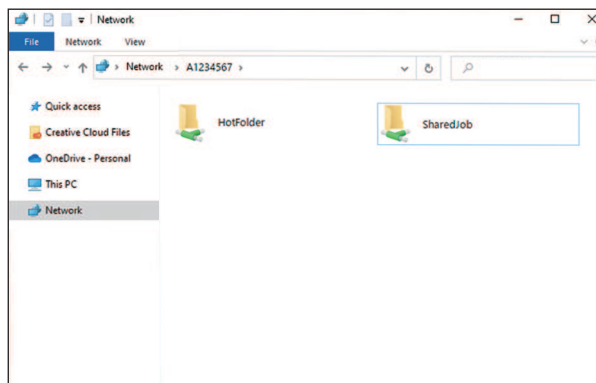

- Please change "*****" to the serial number of the printer.
- From MENU on the touch panel, tap [SYSTEM] > [System information] to display the serial number on the browser screen at right.

With output port set to [File]

Import jobs (RIP data) to the machine (control PC) using an external hard drive (e.g., USB flash memory).

Creating RIP Data

- 1 Launch RasterLink.
 - Click the icon on the RIP PC desktop.



2 Select the image data to print.

- (1) Select [File] > [Open].
- (2) Select the desired image data, then click [Open].
 - If multiple printers are registered, select JFX600-2531 in "Printer Name".

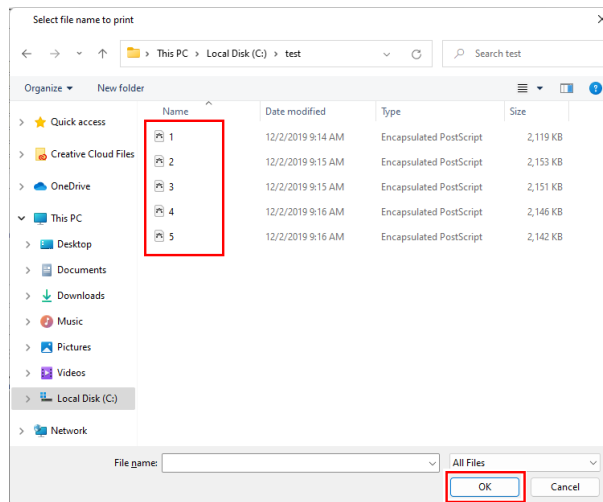

3 Select the image data imported.

- The image is displayed in the tab for JFX600-2531 selected in "Printer name".

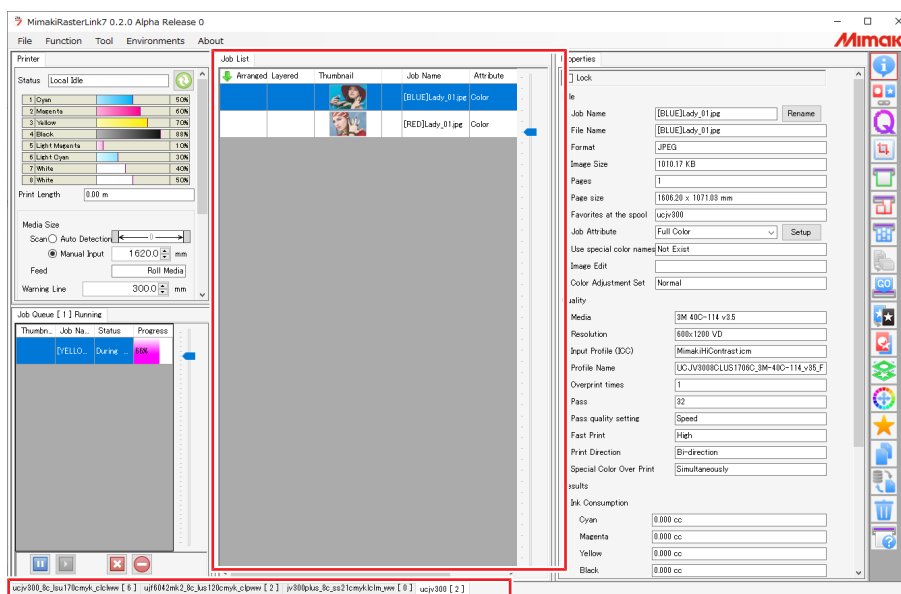

4 Check the settings and alter as necessary.

- Specify the following settings by clicking the function icons shown on the right-hand side of the screen:



(General Print): Specifies settings like enlargement/reduction and number of copies.



(Print Condition): Selects a color profile for the media and ink set loaded in the machine.



- For more information, refer to the RasterLink reference guide. <https://mimaki.com/download/software.html>

5 Prepare a job (RIP data) from image data.

- Click (Execute) from the function icons on the right-hand side of the screen. Select "RIP and Print", then click [Start].

6 Specify the destination and save the job (RIP data).

Saving to an External Hard Drive (e.g. USB Flash Drive)

1 Save the job (RIP data) stored on the RIP computer to an external hard drive.

-  "Creating RIP Data"(P. 87)

2 Connect the external hard drive into the machine (control PC).

3 From MENU on the touch panel, tap [JOB IMPORT].



- A dialog box appears.

(1) Select the removable disk on which you will save the job.

(2) Specify where to save the job.

- To add a folder, tap [ADD NEW FOLDER]. When the dialog box appears, enter a folder name to add the folder.

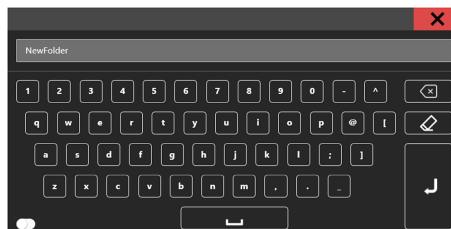

(3) Select the job.

(4) Tap [→] to import the job.

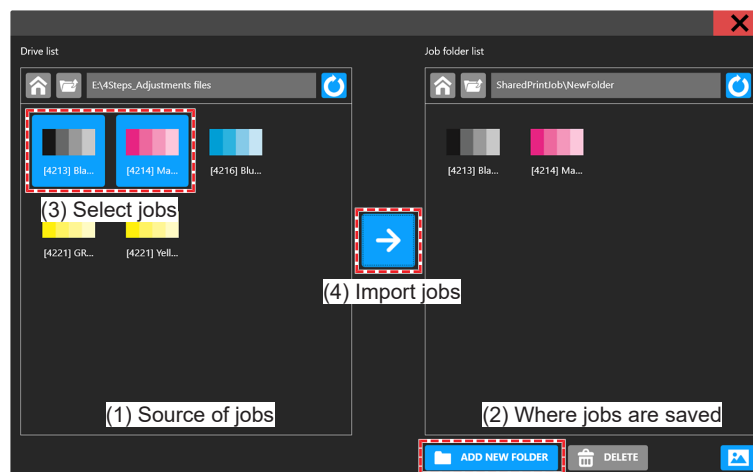

2.11 Printing

Check beforehand

- Is media loaded? 🛠️ "Loading the Media"(P. 59)
- Did you set the media thickness? 🛠️ "Registering the Media Thickness"(P. 70)
- Did you set the head gap? 🛠️ "Setting the Head Gap"(P. 73)

Repositioning the UV-LED Unit

Loosen the screws on both sides of the carriage and slide the UV-LED unit as needed for the colors and spot colors you wish to print.

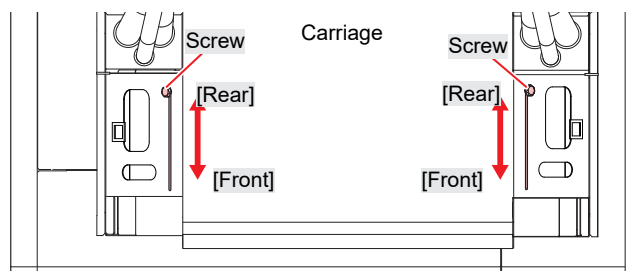

- Keep foreign matter out of the grooves on either side of the carriage where the UV-LED unit slides. Screws or pieces of metal that fall into the grooves may result in fire or smoldering.

UV-LED unit position

the machine supports two-layer printing in separate layers for colors and spot colors.







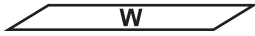

The following position is recommended for the UV-LED unit:

● 4-color, 2W, CL, Pr





| Layer | Layer Printing | UV-LED Unit Position |
|--------------|--------------------------|----------------------|
| Single layer | | Front |
| | | Front |
| | | Front |
| | | Front |
| Two layers | 2nd layer: 1st layer: | Rear |
| | 2nd layer: 1st layer: | Front |
| | 2nd layer: 1st layer: | Front |
| | 2nd layer: 1st layer: | Rear |

● 6-color, W, CL

| Layer | Layer Printing | UV-LED Unit Position |
|--------------|----------------|----------------------|
| Single layer | | Front |

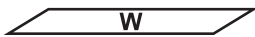
| Layer | Layer Printing | UV-LED Unit Position |
|------------|---|----------------------|
| |  | Front |
| |  | Rear |
| Two layers | 2nd layer:  1st layer:  | Rear |
| | 2nd layer:  1st layer:  | Front |
| | 2nd layer:  1st layer:  | Rear |

● 6-color, 2W

| Layer | Layer Printing | UV-LED Unit Position (mm) |
|--------------|---|---------------------------|
| Single layer |  | Front |
| |  | Front |
| Two layers | 2nd layer:  1st layer:  | Front |
| | 2nd layer:  1st layer:  | Front |

UV-LED Assistance Scan

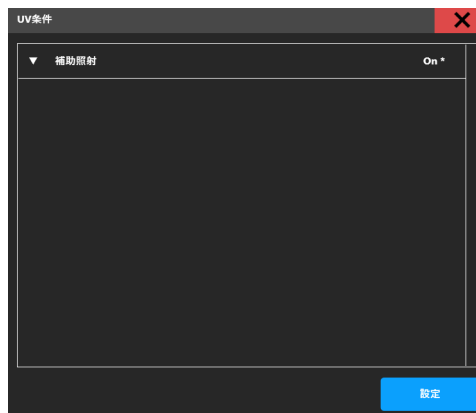

| Assistance scan | Overview |
|-----------------|--|
| ON | <ul style="list-style-type: none"> Assistance scan is used to ensure uniform total light levels from the UV-LED between the print end section and other parts. The range of the scanning UV-LED is controlled to adjust the total light level at the print end section without feeding for UV scanning. Not feeding for UV scanning enables the time taken to complete the print to be reduced. <ul style="list-style-type: none"> Light bands may be prominent depending on the actual printed image. If so, disable assistance scan. |

| Assistance scan | Overview |
|-----------------|--|
| | <p>– The MPC job status screen changes to [Additional scan] during assistance scan.</p> <div data-bbox="493 197 1329 389" style="border: 1px solid black; padding: 5px;"> <p>Print origin : 0 x 0 mm Image size : 838 x 457 mm Media thickness : 3.0 mm 600 x 600 2p Bi High Head gap : 1.5 mm</p> <hr style="border: 2px solid green;"/> <p style="border: 1px solid red; padding: 2px;">Additional scan in progress 100 %</p> <p style="text-align: right;">0.45 / 0.45 m Layer (1 / 1)</p> </div> |
| OFF | <ul style="list-style-type: none"> • Assistance scan is not used at the print end section. • There may be variations in total light levels between the print end section and other parts, resulting in quality differences due to hardening variations. <ul style="list-style-type: none"> – If quality differences occur, try creating and printing a job with blank space added at the end of the print to ensure uniform total light levels over the entire print. |



- If assistance scan is set to OFF (ON is recommended), problems such as ink hardening or banding (stripes) may occur. Keep it in mind when altering the setting.

Starting Printing

- 1 From QUICK MENU on the touch panel, set [Continuous print] to ON (○ in upper left of icon: green).

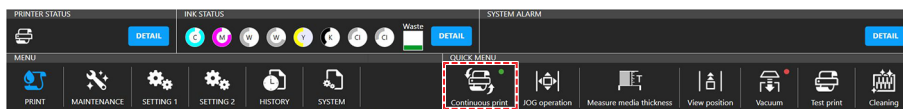

- To save a job to the queue, set to OFF (○ in upper left of icon: red). After the job is saved to the queue, turn on continuous printing.

- 2 Tap [JOB LIST] and select the job to print.

- A dialog box appears.

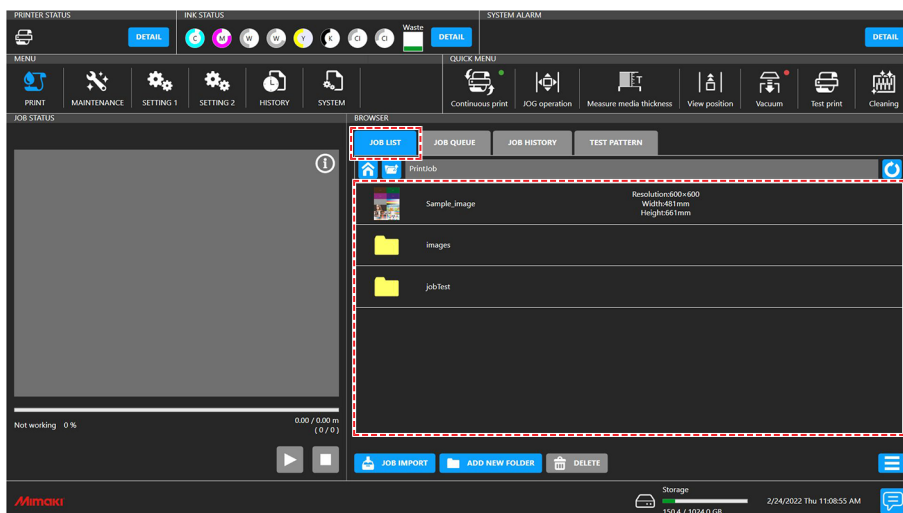

- If you wish to delete a job, tap and hold (long tap) on the job and then tap [Delete]. Jobs deleted any other way will remain listed in [JOB LIST].

3 Set the print conditions.

- 👉 "Setting Print Conditions"(P. 93)

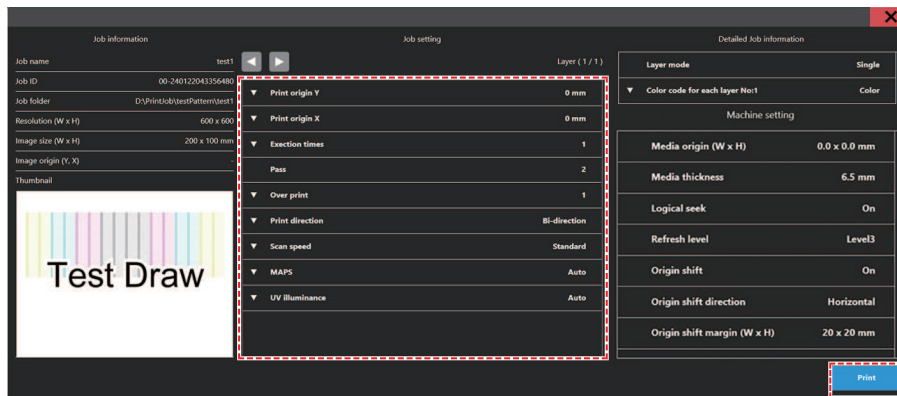

4 Tap [Print].

- Printing starts once the machine receives the job. Check printing progress in the print status area. 👉 "Mimaki Printer Controller"(P. 106)



- Print speeds may differ for the same image data, depending on the width of the medium loaded, print origin position, and resolution.
- Any errors will prevent further printing.
- The ink used in the machine is warmed before printing. Printing is disabled while the ink is warmed.

Setting Print Conditions

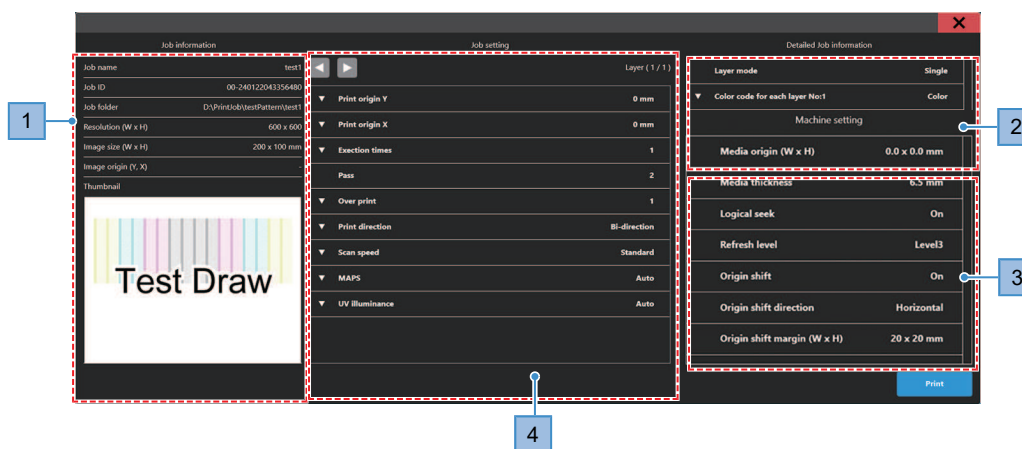

| No. | Name | Overview |
|-----|--------------------------|--|
| 1 | Job Information | Check the job information as needed. |
| 2 | Detailed Job Information | Check the job details as needed. |
| 3 | Machine setting | Check the machine settings information as needed. |
| 4 | Print origin Y | Enter the print origin in the scan (horizontal) direction. 👉 "Print Origin"(P. 94) |
| | Print origin X | Enter the print origin in the feed (vertical) direction. 👉 "Print Origin"(P. 94) |
| | Execution times | Set the number of times to print. The specified number of times is displayed on the queued jobs. |
| | Pass | Cannot be configured. The number of passes varies by resolution. |

| No. | Name | Overview |
|-----|-----------------|--|
| | Over print | Set the number of layers in overprinting. |
| | Print direction | Set to print unidirectionally or bidirectionally. |
| | Scan speed | Set the carriage scanning speed. |
| | MAPS* | Set whether to use Auto or Presets 1 to 3 (☞ "Setting 1 Menu"(P. 117)). Selecting manual enables individual settings for each job. |
| | UV illuminance | Set whether to use Auto or Presets 1 to 8 (☞ "Setting 1 Menu"(P. 117)). Selecting manual enables individual settings for each job. Changing UV illuminance may reduce the warp of printed media. |
| | Setup | Sets the illuminance used for printing. <ul style="list-style-type: none"> • [Auto]: The recommended illuminance value for print conditions is used. • [Manual]: The entered illuminance value is used. • Presets: The illuminance value for the selected preset is used. |
| | Illuminance | Sets the illuminance value used for printing. <ul style="list-style-type: none"> • Setup is set to [Auto]: "-" is displayed. • Setup is set to [Manual]: Enter the illuminance value. (-100 to 50 %) • Setup is set to any Preset: The preset illuminance value is displayed. |
| | Print area | Selects the table for printing when using toggle printing. (Not displayed when the toggle printing mode is full board.) |
| | Front | Prints on the front table. |
| | Rear | Prints on the rear table. |
| | Automatic | Prints alternately on the front and rear table for each job. <ul style="list-style-type: none"> • It refers to the print area printed on immediately beforehand. • Prints on the front table when printing for the first time after startup. |



Illuminance value

- If the illuminance value is 0%, the default UV-LED setting is used for printing.
- If the illuminance value is -100%, UV-LED is completely off during printing.

Print Origin

The print start position can be altered.

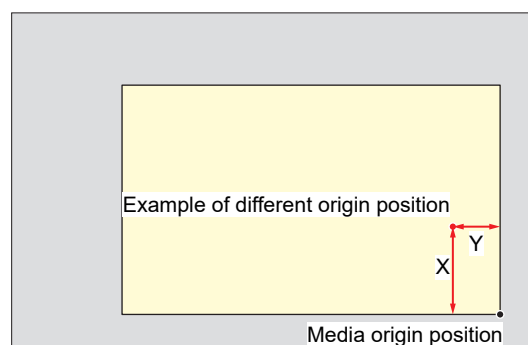





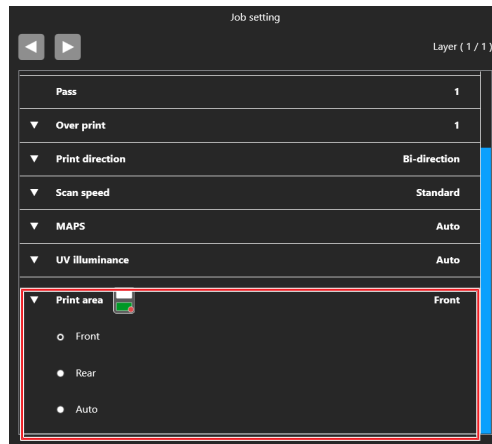

Specify the table for printing

1 Tap [JOB LIST] and select the job to print.

- A dialog box appears.

2 Select the table to be printed on from [Print Area].



| Icon | Print area |
|---|---------------------|
|  | Front (FF mode) |
|  | Rear (FF mode) |
|  | Automatic (FF mode) |
|  | Front (FR mode) |
|  | Rear (FR mode) |
|  | Automatic (FR mode) |

3 Tap [Print].

- Printing starts for the print area selected.



- The toggle print mode and print area set for each job can be checked in queued jobs.

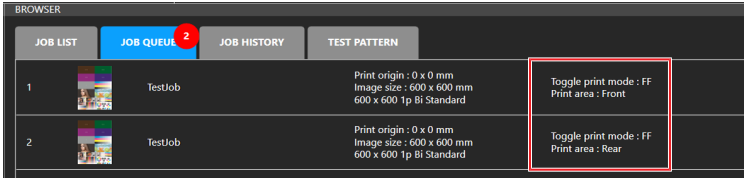

- The job status box indicates the print area for the job displayed.

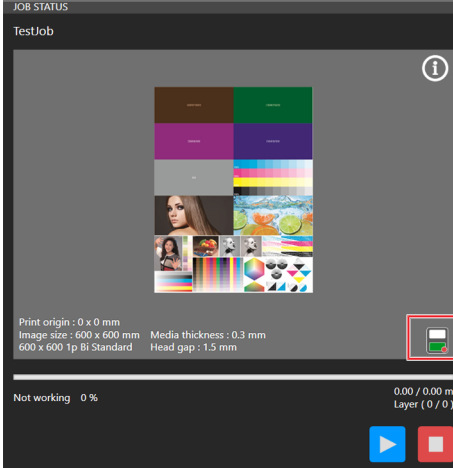

- When the print area is set to Automatic, the printing position can be checked from the next print area.

* If there are jobs for which printing has not yet started in the queued jobs or job status box, the print area is displayed for the first job.

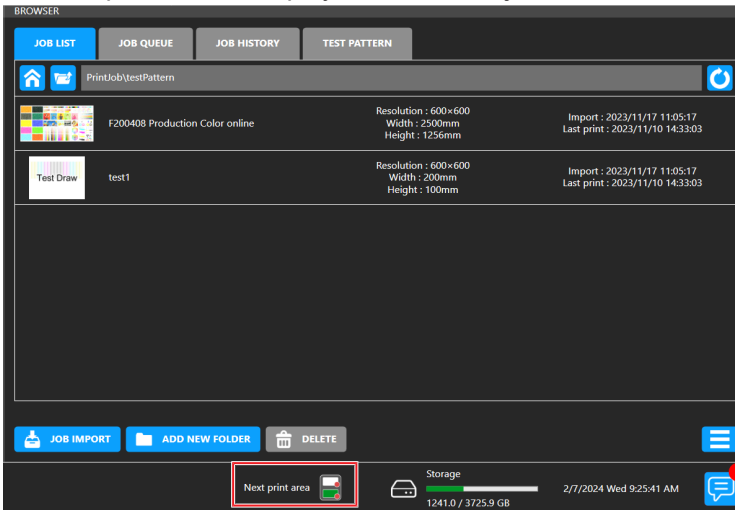

Pausing Printing

1 While printing is in progress, tap [Pause].

- Printing pauses.



- Some functions are not available while printing is paused.

2 Tap [Resume].

- Printing resumes.



Stopping Printing

1 Tap [Stop] to cancel printing.

- After cancellation, the carriage returns to the station.
- Any subsequent jobs are displayed in the print status area. To resume printing, tap [Resume].

Moving the Y-Bar

After printing, the carriage returns to the station, but the Y-bar does not move. If you wish to check the printing results or other aspects of the current status, move the Y-bar to the view position.

Moving the Y-Bar to the View Position

1 From QUICK MENU on the touch panel, tap [View position].

- A dialog box appears.

2 Tap [Move to view position [Rear]] or [Move to view position [Front]].

- The Y-bar moves to the view position.

Changing the View Position

1 From MENU on the touch panel, tap [SETTING 2].**2 Tap [View position] > [View position].**

- A dialog box appears.

3 Enter the view position.

- Tap [-] / [+] to enter the value.

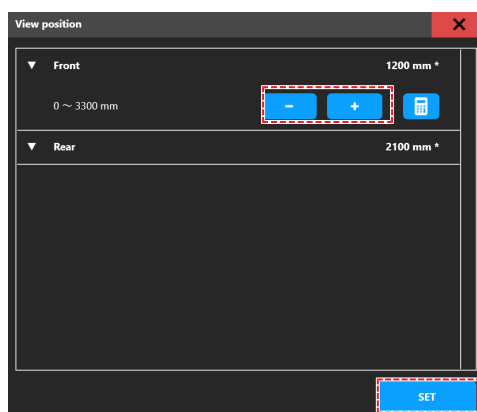

- Use the [Numeric keypad] to enter your specified value.

(1) Tap .

- A dialog box appears.

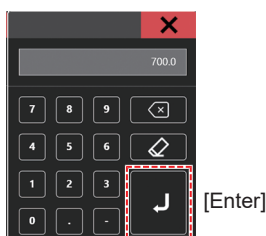

(2) Enter the preferred value, then tap [Enter].

4 Tap [SET].

Printing Using Nozzle Recovery

Nozzle recovery is a function that is useful when nozzle clogging cannot be resolved for specific nozzles. When nozzle recovery is enabled in Mimaki Printer Controller (MPC), if a nozzle is determined to be "nozzle clogging" in the nozzle check, normal nozzles are used supplementarily during printing.

Automatically Detecting and Registering Nozzle Clogging

When nozzle checking is executed on the machine, the NCU, which monitors the print head nozzle status, automatically detects and registers the location where a nozzle is clogged.

There are two types of nozzle checking: "Nozzle check" performed as required by the user, and "Nozzle check before print" performed automatically before starting printing.

● Nozzle Check

This performs nozzle checking to manually detect and register those nozzles that are clogged.

1 From MENU on the touch panel, tap [MAINTENANCE].

- The Maintenance menu is displayed.

2 Tap [Nozzle Recovery] > [Nozzle check].

- A dialog box appears.
- [Nozzle check] is selected for [Test type].

3 Set [Nozzle judge condition] to the number of clogged nozzles used to determine nozzle clogging.

- Up to 64 nozzles per color can be set.

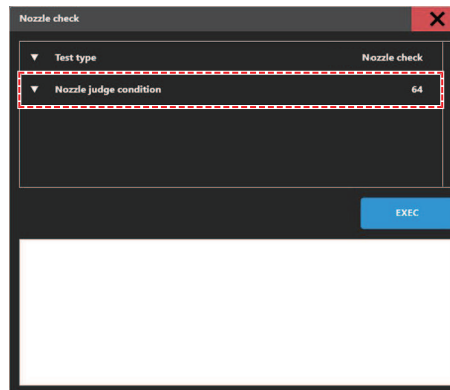

4 Tap [EXEC].

- When nozzle checking is complete, the result is displayed on the screen, and the clogged nozzle locations are automatically registered. To close the window, tap [x] at the top right of the window.

| Nozzle check result : NG | | |
|--------------------------|---------|--------|
| Code | Color | Nozzle |
| 0x00 | : Black | 1 |
| 0x00 | : Black | 2 |
| 0x00 | : Black | 3 |
| 0x00 | : Black | 4 |
| 0x00 | : Black | 5 |
| 0x00 | : Black | 6 |
| 0x00 | : Black | 7 |
| 0x00 | : Black | 8 |
| 0x00 | : Black | 9 |
| 0x00 | : Black | 10 |
| 0x00 | : Black | 11 |

● Nozzle check before print

When printing, nozzle checking is automatically performed before printing starts. When this function is enabled, nozzle checking is performed automatically before printing starts, so printing is stopped for approximately four minutes to allow nozzle checking to be performed.

1 From MENU on the touch panel, tap [MAINTENANCE].

- The Maintenance menu is displayed.

2 Tap [Nozzle Recovery] > [Nozzle check before print].

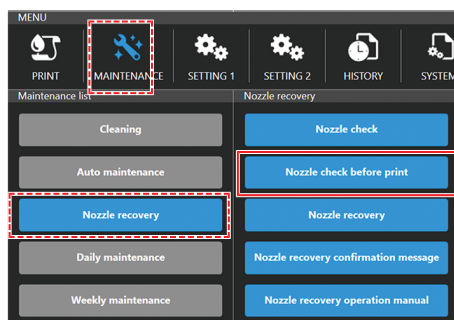

- A dialog box appears.

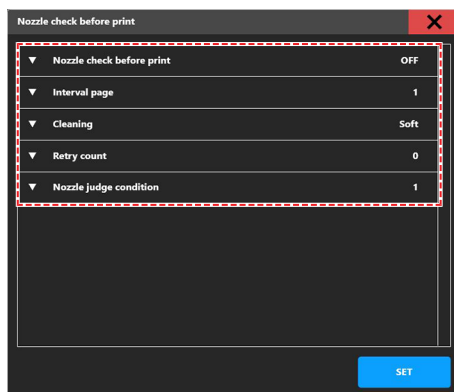

- (1) Nozzle check before print: Default is "Off"
Setting to "On" performs nozzle checking using the set [Interval].
- (2) Interval page: Default is "30"
After the set number of prints, nozzles are checked before printing the next job.
- (3) Cleaning: Default is "Soft"
Performs cleaning automatically when the nozzle check detects an error. This parameter sets the type of head cleaning.
- (4) Retry count: Default is "0"
If nozzle checking detects nozzle clogging in more nozzles than the number set for [Nozzle judge condition], nozzle recovery (cleaning > nozzle checking) is performed for the specified number of cycles.
The print sequence is automatically resumed once the number of clogged nozzles after cleaning is fewer than the number set for [Nozzle judge condition].
- (5) Nozzle judge condition: Default is "1"
Sets the number of clogged nozzles that is permissible to allow printing to continue. If the number of clogged nozzles detected exceeds this setting, the system determines that continued printing is not possible, and printing stops.
* Up to 64 nozzles can be set per color.

3 Tap [SET].

- The [Nozzle check before print] setting is updated.
- After printing the number of pages set in [Interval page ^{*1}], nozzle checking is performed, and the clogged nozzle locations are automatically registered.



- Pages *1: The sequence of events from print preparation to print completion and carriage return to the station is counted as one page. For this reason, for some multi-layer printing jobs and 2.5D jobs, the number of pages is counted up for each layer printed.
- The number of pages for each job can be checked using "Layer (*/*)" on the MPC print conditions screen.

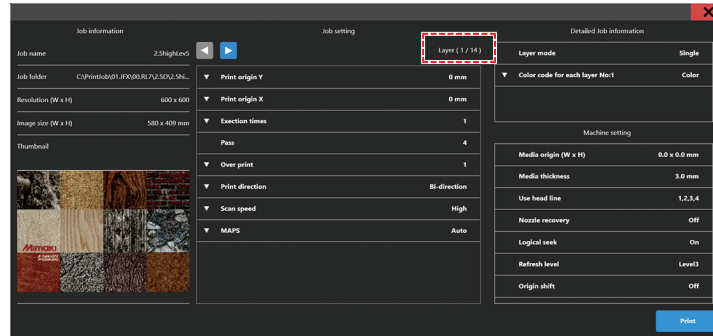

Setting Nozzle Recovery

● Enabling nozzle recovery

This prints using the normal nozzles to recover the clogged nozzles registered in  "Automatically Detecting and Registering Nozzle Clogging"(P. 98). Nozzle recovery can be used by enabling the setting in MPC.

1 From MENU on the touch panel, tap [MAINTENANCE].

- The Maintenance menu is displayed.

2 Tap [Nozzle Recovery] > [Nozzle Recovery].

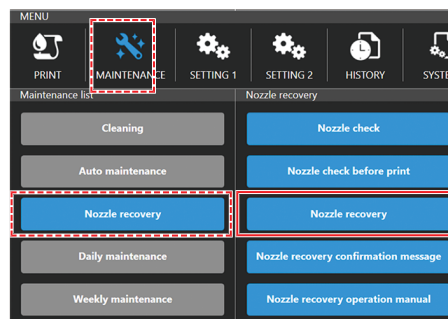

3 Tap [Mode] to turn it on, then tap [SET].

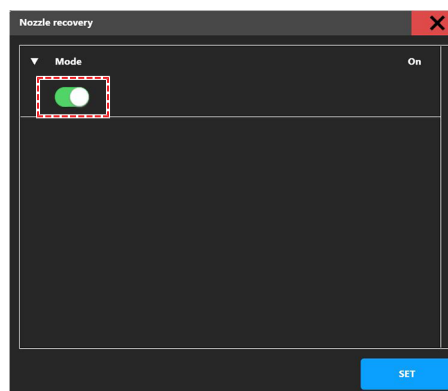



- Using this function does not change the time required for printing.
- If the print conditions are set to the minimum number of passes in the RIP software, the nozzle recovery function will be disabled.
- Recovery functions during image printing when nozzle recovery has been registered and enabled, but recovery will not be applied to print patterns such as test printing and dot position correction.

● Checking nozzle recovery settings

The nozzle recovery operation conditions set in ["Enabling nozzle recovery"](#)(P. 101) can be checked as follows:

- 1 Check the Nozzle recovery setting ("On" or "Off") in "Machine setting" on the print conditions screen.

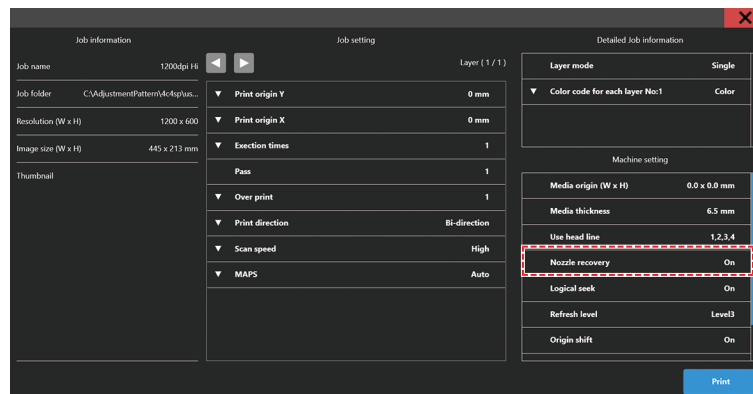

- 2 Check the nozzle recovery setting ("Off", "Disabled", or "Enabled") on the JOB STATUS check screen after starting printing.

- "Disabled" is displayed when the Nozzle recovery setting is "On" and some of the clogged nozzles cannot be recovered.
- "Enabled" is displayed when the Nozzle recovery setting is "On" and all of the clogged nozzles can be recovered.

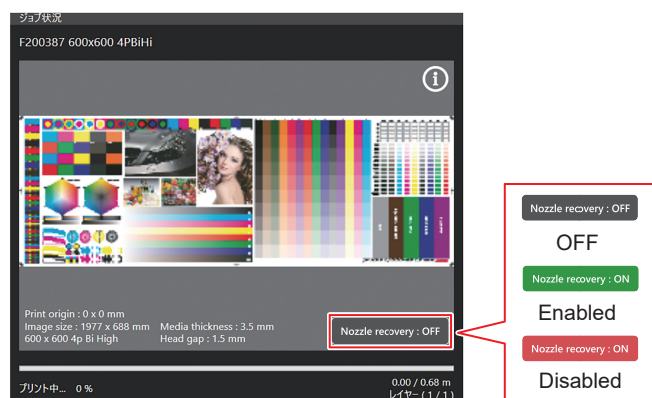

Nozzle recovery confirmation message

● Setting "Nozzle recovery confirmation message"

"Nozzle recovery confirmation message" is a function that displays a print start confirmation message corresponding to the registered nozzle clogging information. When Nozzle recovery is turned on, enabling "Nozzle recovery confirmation message" causes a message to be displayed to confirm whether you wish to start printing. The message details are described in ["Nozzle recovery confirmation message details"](#)(P. 104).

- 1 From MENU on the touch panel, tap [MAINTENANCE].
 - The Maintenance menu is displayed.
- 2 Tap [Nozzle recovery] > [Nozzle recovery confirmation message].

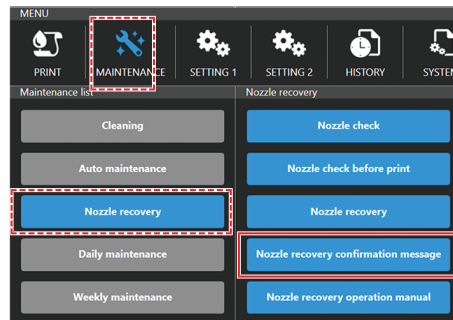

- 3 Tap [Display setting] to enable it.

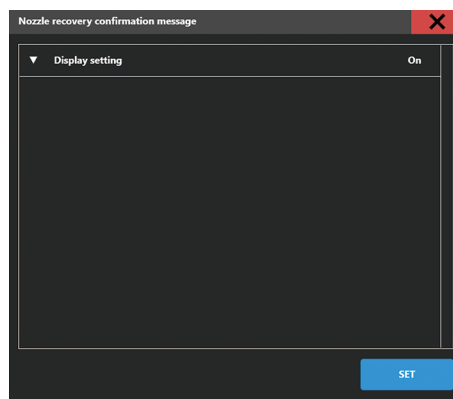

● Nozzle recovery confirmation message details

A confirmation message is displayed before the start of printing to continue with nozzle recovery when certain conditions apply. There are three different patterns for the confirmation messages, as follows:

- (1) For print conditions in which nozzle recovery does not apply
→ Indicates that printing will be performed in Draft mode (fastest scan mode using the fewest passes).

Change the following settings to enable nozzle recovery:

- Increase the number of passes
- Reduce the MAPS speed
- Change the scan speed from "High" to "Normal"

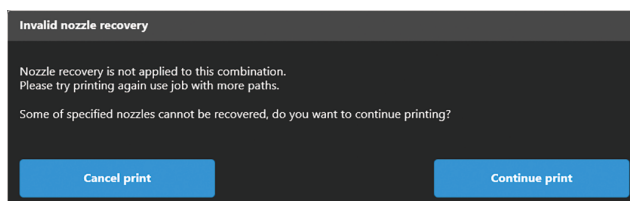

- (2) When nozzles exist that cannot be recovered using nozzle recovery (Case 1)
→ Displayed in cases where nozzle recovery is effective by reducing the MAPS speed even when the nozzles to assist the clogged nozzles are themselves clogged. Selecting [Apply settings and continue print] on the message screen reduces the printing speed, but allows printing to be performed by enabling nozzle recovery.

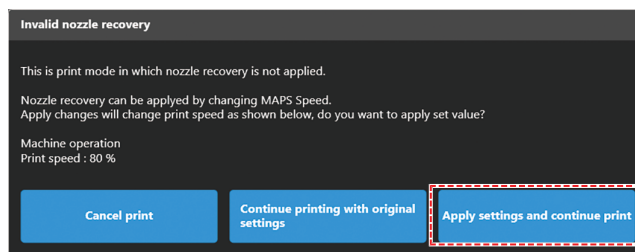

- For information on MAPS settings, refer to  "Setting 1 Menu"(P. 117).

- (3) When nozzles exist that cannot be recovered using nozzle recovery (Case 2)
→ Displayed when nozzle recovery is not practical even by reducing the MAPS speed. Change the following settings to enable nozzle recovery:

- Increase the number of passes
- Change the scan speed from "High" to "Normal"

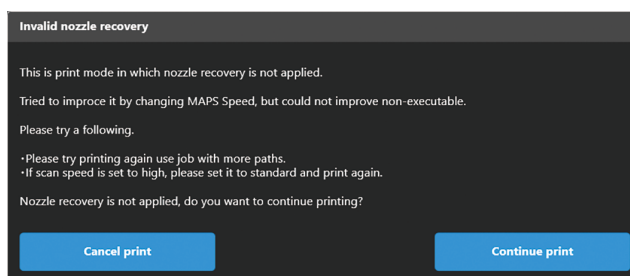

Chapter 3 Settings (MPC)



This chapter

This chapter describes various functions of the MPC (Mimaki Printer Controller).

| | | | |
|-----------------------------------|-----|--|-----|
| Mimaki Printer Controller | 106 | Setting 1 Menu | 117 |
| Screen structure | 106 | Setting UV illuminance presets and default | 119 |
| Checking the default values | 109 | Setting 2 Menu | 122 |
| Print menu | 110 | History Menu | 123 |
| Maintenance Menu | 111 | System menu | 124 |
| Nozzle Check Before Print | 113 | Power Supply | 124 |
| Regist nozzle recovery | 113 | | |

3.1 Mimaki Printer Controller

MPC software is used to operate and control the JFX600-2531. The Mimaki Printer Controller is installed on the control PC. The touch panel is used for MPC operations.

Screen structure

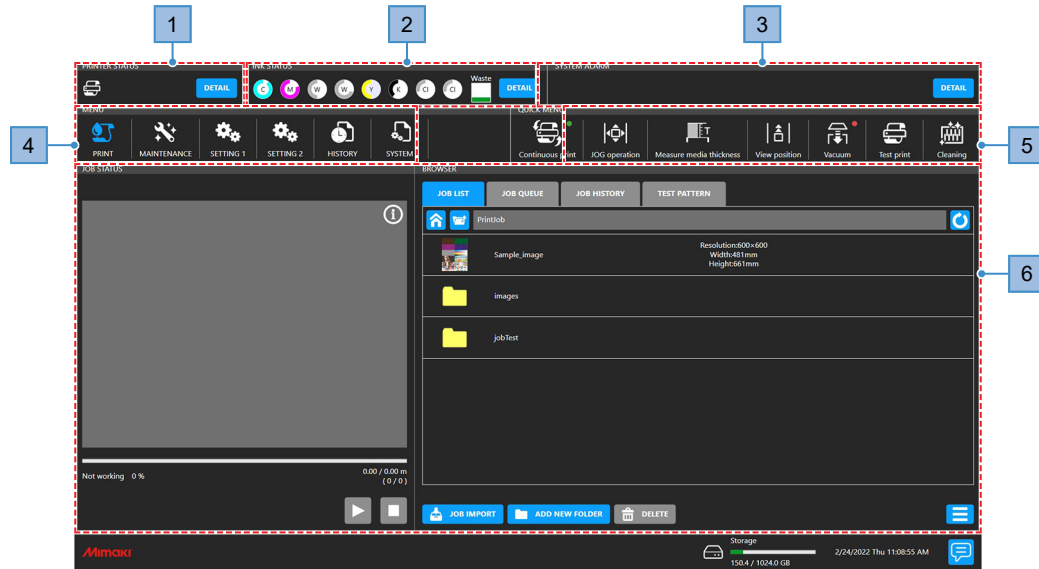

| No. | Item | Overview |
|-----|--|--|
| 1 | PRINTER STATUS (printer information area) | Machine status is indicated by icons. "PRINTER STATUS"(P. 107) <ul style="list-style-type: none"> : Displays the status of each component of the configuration. |
| 2 | INK STATUS (ink information area) | Icons indicate remaining ink levels, ink errors, and other Ink bottle status information. "INK STATUS"(P. 107) <ul style="list-style-type: none"> : Displays the Ink bottle slot number and ink color. |
| 3 | SYSTEM ALARM (system information area) | Of various possible errors, this area shows the most important errors. "SYSTEM ALARM"(P. 108) <ul style="list-style-type: none"> : Displays all current errors. |
| 4 | MENU (menu area) | Shows various menus. <ul style="list-style-type: none"> (PRINT): Set print conditions/settings for the media used. "Print menu"(P. 110) (MAINTENANCE): Menu used for machine maintenance "Maintenance Menu"(P. 111) (SETTING 1): Used to set various printing-related operations "Setting 1 Menu"(P. 117) (SETTING 2): Used to set various operations for the machine "Setting 2 Menu"(P. 122) (HISTORY): Shows maintenance records and other information. "History Menu"(P. 123) (SYSTEM): Shows various information about the machine. "System menu"(P. 124) |

| No. | Item | Overview |
|-----|---------------------------------|---|
| 5 | QUICK MENU (quick menu area) | Shows frequently used menus. <ul style="list-style-type: none"> (Continuous print): Prints jobs continuously. (JOG operation): Moves the carriage. Setting the Media Origin (Measure media thickness): Automatically register media thickness. "Registering the Media Thickness"(P. 70) (View position): Moves the Y-bar to the view (evacuation) position. "Moving the Y-Bar"(P. 97) (Vacuum): Applies suction to hold media in place. "Load the media."(P. 60) (Blower): Lifts the media off the table surface. (Only appears when the blower is connected.) (Test print): Prints a test pattern to confirm that the ink prints correctly. "Test Printing"(P. 74) (Cleaning): Clean the heads in case of ejection failures (e.g., nozzle clogging, deflection). "Head Cleaning"(P. 78) |
| 6 | (Content area) | Shows setting screens for the selected menu. |

PRINTER STATUS

Icons indicate the machine status. Tap [Detail] to display the status of each component of the configuration.



● Icon display

| Icon | Overview |
|------|--|
| | Local mode. Used for test printing, maintenance, and settings |
| | Printing in progress. |
| | Printing is paused. |
| | Maintenance is in progress. No other operations can be performed while maintenance is underway. |
| | Obstruction detected. |
| | The light curtain is disabled. Machine operation continues even if the light curtain is blocked. |

INK STATUS

Icons indicate remaining ink levels, ink errors, and other Ink bottle status information. Tap [Detail] to display the slot number and ink color.

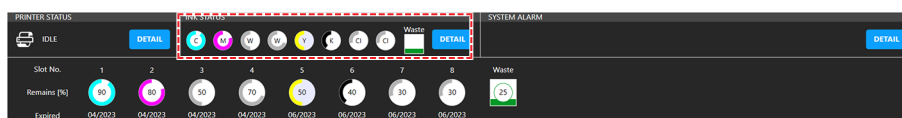

● Icon display

| Icon | Overview |
|------|--|
| | Remaining ink levels are indicated graphically and as percentages. |
| | A blue warning icon appears in the lower right if ink runs low. Very little ink remains. Have new ink ready. |
| | A yellow warning icon appears in the lower right if ink runs out or ink errors occur. Printing is not possible. |
| | A red warning icon appears in the lower right if the ink is past its expiration date. Replace with new ink or use up as quickly as possible. Printing is possible. "Restrictions Concerning the Expiration Date of Ink Used in the Machine"(P. 22) |
| | Waste ink levels are indicated as percentages. |

SYSTEM ALARM

Of various possible errors, this area shows the most important errors. Tap [Detail] to display all current errors.

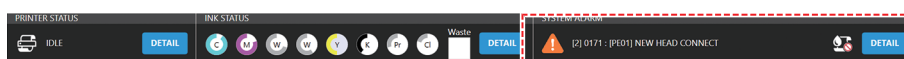

● Alarm display

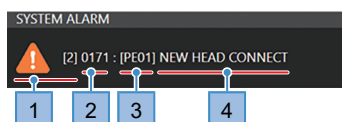

| No. | Overview | |
|-----|----------|--|
| 1 | Level | (Level 0): Printing is possible. Printing will continue even if these errors occur during printing. • Examples: Ink near end, ink expired (1 month past) |
| | | (Level 1): Printing and cleaning is not possible. Any printing underway will pause if any of these errors occur. Take appropriate measures based on the message. • Examples: Ink depleted, ink IC chip not inserted |
| | | (Level 2): Printing and cleaning is not possible. Any printing underway is aborted if any of these errors occur. Take appropriate measures based on the message. • Examples: Ink overflow |
| | | (Level 3): No machine operations are possible. Take appropriate measures based on the message. If you see this message repeatedly, contact your local dealer or our service office. |
| 2 | Code | Refer to the error code list. "Problems Causing Messages to Appear"(P. 161) |
| 3 | Unit | Not disclosed; used for service |
| 4 | Contents | Refer to the error code list. "Problems Causing Messages to Appear"(P. 161) |

Clearing Alarms

1 Tap [DETAIL].

- Displays all current errors.

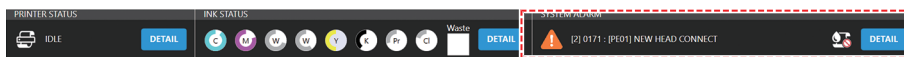

2 Resolve the cause of the error.

- ["Problems Causing Messages to Appear"\(P. 161\)](#)

3 Tap [CLEAR ALARM].

- This clears the error.

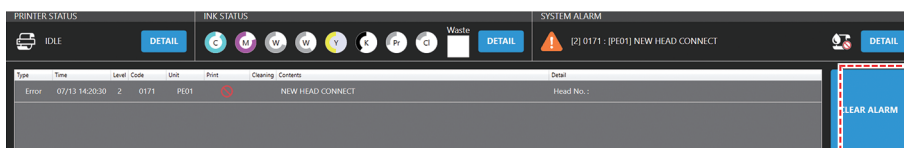

Important!

- If this does not clear the error/alarm, your response may be incorrect or inadequate. Check the alarm details once again and take corrective action. If this alarm recurs, contact your local dealer or our service office.

Checking the default values

The maintenance menu and the settings dialog boxes for the setup menus can be used to check whether the current input values are the default values.

In the example below, the default value for [Cleaning (Standby)] is checked.

1 From MENU on the touch panel, tap [MAINTENANCE].

2 Tap [Auto maintenance] > [Cleaning (Standby)].

- A dialog box appears.

3 Check the settings.

- If "*" is displayed at the right of the setting, the current input value is the default value.

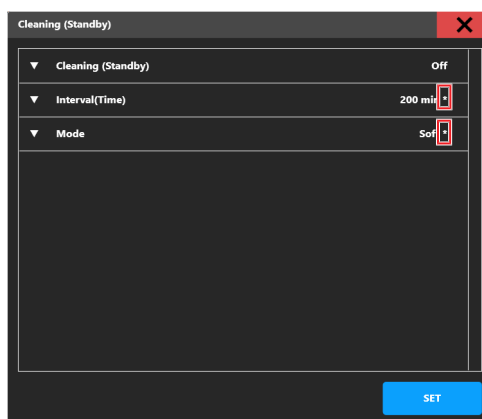



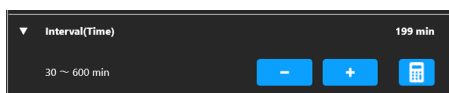





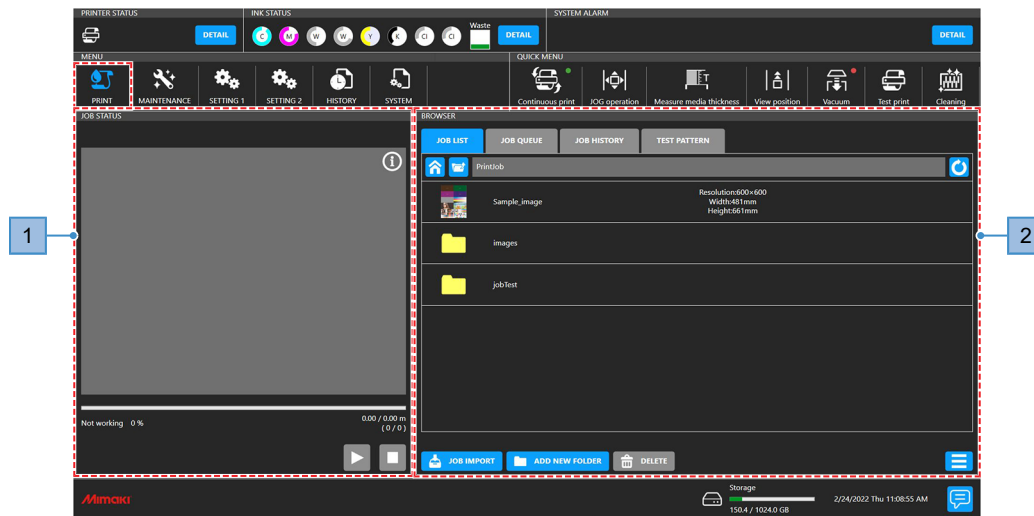



- "*" disappears when the corresponding input value is changed from the default value.

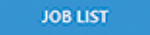
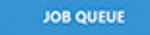

3.2 Print menu

Set print conditions/settings for the media used.









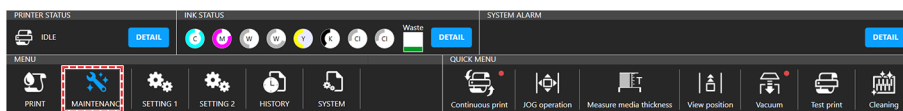



| No. | Item | Overview |
|-----|-----------------|---|
| 1 | Job status area | <p>Displays a job thumbnail and print status.</p> <ul style="list-style-type: none"> : Pause the job currently being printed. : Resume printing. : Cancel printing. |
| 2 | Browser area | <p>List print jobs. Tap a job to display a dialog box for setting print conditions/settings.  "Setting Print Conditions"(P. 93)</p> <ul style="list-style-type: none"> : Show the jobs stored on the control PC. : Show queued jobs. Numbers in the upper right of the icon indicate the number of queued jobs. : Show printed jobs. Tap on a job to print it. : Show jobs used for test patterns. : Show the home folder. : Show the folder one level above. : Update the folder display. : Import the job into MPC.  "With output port set to [File]"(P. 87) : Create a new folder. A dialog box appears. : Delete the job. Jobs deleted any other way will remain listed in [JOB LIST]. : Lets you sort or otherwise change how the job list is displayed. |

3.3 Maintenance Menu

This menu is used for machine maintenance.



| Item | Overview |
|---------------------------|---|
| Cleaning | Print a test pattern to clean the heads in case of ejection failures (e.g., nozzle clogging, deflection). 🖨️ "Head Cleaning" (P. 78) |
| Cleaning | Three types of head cleaning are available. Choose the method based on test results. |
| Ink fillup (Print head) | Fills the ink to resolve ejection failures (e.g., nozzle clogging, deflection). |
| Auto Maint. | Set the conditions to start print head cleaning automatically. The default values (recommended values) are set for auto maintenance. Altering the settings ^{*1} may increase the risk of ejection failures (e.g., nozzle clogging or deflection). (*1: Such as decreasing the maintenance frequency) |
| Cleaning (Standby) | Default: Every 200 min/SOFT cleaning <ul style="list-style-type: none"> Cleaning (Standby): When this is turned on, head cleaning will be performed once the [Interval (Time)] has elapsed. Set to OFF if you prefer not to clean automatically. Interval (time): Cleans heads after the specified value is exceeded. Mode: Set type of cleaning. |
| Flushing (Standby) | Default: Every 50 min <ul style="list-style-type: none"> Flushing (Standby): Set to ON for flushing. Flushing reduces nozzle clogging via regular print head ink discharge. Interval (time): Flushes heads after the specified value is exceeded. |
| Cleaning before print | Default: Based on printing area/Every 16.2 square meters/Normal cleaning <ul style="list-style-type: none"> Cleaning before printing: Set to ON to clean using [Interval type], [Interval], and [Mode] set. Mode: Set type of cleaning. Interval type: Sets the parameter for determining the interval. Interval (Pages): The head is cleaned after the number of files printed exceeds the specified value. (Default value: 5 pages) Interval (Print area): The head is cleaned after the printed area exceeds the specified value. (Default value: 16.2 square meters) |
| Nozzle recovery | Allows other nozzles to be used for printing if maintenance actions like nozzle washing fail to resolve ejection failures (e.g., nozzle clogging, deflection). 🖨️ "Nozzle Check Before Print" (P. 113) |
| Nozzle Check | Performs a nozzle check. |
| Nozzle check before print | Automatically performs nozzle checks (nozzle clogging detection) before printing begins. <ul style="list-style-type: none"> Nozzle check before print: Set to ON for nozzle checking using the set [Interval]. Interval page: After the set number of prints, nozzles are checked before printing the next job. Cleaning: Sets the type of head cleaning to be performed automatically when the nozzle check detects an error. Retry count: Performs nozzle recovery (cleaning followed by nozzle checking) for the specified number of times. |

| Item | Overview |
|--------------------------------------|---|
| | <ul style="list-style-type: none"> Nozzle clogging judgment condition: Set the number of clogged nozzles used to determine nozzle clogging. Up to 64 nozzles per color can be set. The next print will not start if "nozzle clogging" is detected during continuous printing. |
| Nozzle recovery | Performs nozzle recovery automatically if nozzle clogging is detected. <ul style="list-style-type: none"> Mode: Set to ON for automatic nozzle recovery. |
| Nozzle recovery confirmation message | If nozzle recovery cannot be performed, setting [Nozzle Recovery Confirmation Message] to OFF will start printing without displaying the print continuation confirmation dialog box. |
| Nozzle recovery operation guide | Shows the nozzle recovery operation guide. |
| Regist nozzle recovery | This displays the currently registered nozzle check results. It also allows you to manually register and clear abnormal nozzles.  "Regist nozzle recovery" (P. 113) |
| Daily maintenance | Lists items for which daily maintenance should be performed. |
| Daily station maintenance | Moves the carriage for cleaning around the station. <ul style="list-style-type: none">  "Wiper Cleaning"(P. 130)  "Cap Rubber Cleaning"(P. 132)  "NCU Cleaning"(P. 133) |
| Head maintenance | Moves the carriage to the maintenance space for cleaning in the print head area.  "Carriage Underside Cleaning" (P. 134) |
| Weekly maintenance | Lists items for which weekly maintenance should be performed. |
| Weekly station maintenance | Moves the carriage for cleaning around the station.  "Station Area Cleaning" (P. 132) |
| Cleaning the ink discharge path | Washes the suction pump tube (below the cap).  "Waste Ink Draining Channel Cleaning" (P. 136) |
| Other maintenance | Lists maintenance items to inspect in the event of errors. |
| Sub-tank maintenance | Used in case of sub-tank related errors |
| Replace waste ink tank | Once ink levels in the waste ink tank reach the specified value, "0604 CHECK WASTE BOTTLE" will appear in SYSTEM ALARM on the touch panel. Use this as a guide for replacing the waste ink tank.  "Waste Ink Tank Replacement" (P. 149) |
| Refill cooling water | Once the specified value is reached, "0705 WATER LACK" will appear in SYSTEM ALARM on the touch panel, and a buzzer will sound. Refill cooling water mixed with antifreeze (1 part antifreeze to 2 parts water).  "Refilling Cooling Water (Mixed With Antifreeze)" (P. 150) |
| Adjust positive pressure | Adjusts pressure in case of pressure-related errors.  "A pressure error occurred." (P. 158) |
| Adjust negative pressure | |
| Grease up X-LM block | Greases the X-LM blocks when the greasing time is reached.  "Periodic Lubrication of the LM Blocks" (P. 138) |

| Item | Overview |
|-------------------------|--|
| Replace parts | Displays replacement instructions for components requiring periodic replacement. |
| Replace Wiper | The machine maintains a count of the number of wiping cycles. Once the specified value is reached, "0605 REPLACE WIPER" will appear in SYSTEM ALARM on the touch panel. Replace dirty or warped wipers with new ones. "Wiper Replacement"(P. 145) |
| Replace flushing filter | The machine counts the amount of ink used in flushing. When a specified value is reached, a message is displayed in SYSTEM ALARM on the touch panel recommending replacement of the flushing filter. Use this a guide for replacement. "Flushing Filter Replacement"(P. 147) |
| Replace NCU absorbent | If the NCU ink pad must be replaced, "0657 Check NCU waste ink" will appear in SYSTEM ALARM on the touch panel. Use this a guide for replacement. "NCU Ink Pad Replacement"(P. 147) |

Nozzle Check Before Print

This is used to check if the nozzles are clogged before printing. Set whether to perform maintenance functions automatically if nozzle clogging is detected.

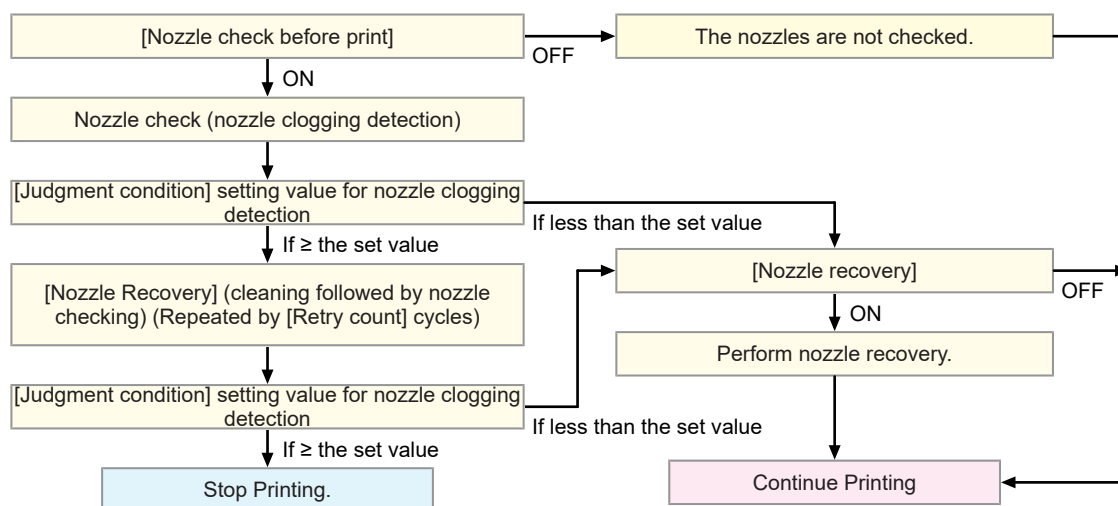

Regist nozzle recovery

Nozzle Recovery Registration Dialog

This displays the currently registered nozzle check results. It also allows abnormal nozzles to be registered and cleared manually.



1 From MENU on the touch panel, tap [MAINTENANCE].

- The Maintenance menu is displayed.

2 Tap [Nozzle Recovery] > [Regist nozzle recovery].

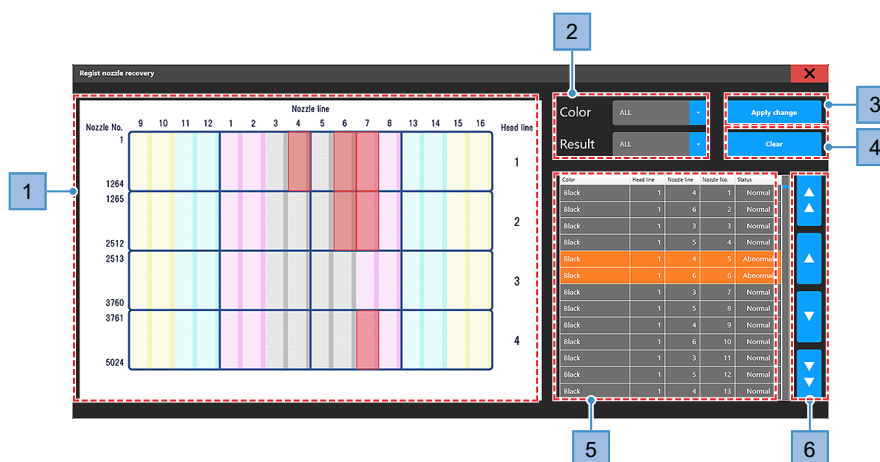
- A dialog box appears.



| No. | Name | Overview |
|-----|------------------------------|---|
| 1 | Nozzle image | Displays an image corresponding to the nozzle recovery table. <ul style="list-style-type: none"> • Clogged nozzle locations flash red. |
| 2 | Nozzle recovery table filter | This allows the details in the nozzle image and nozzle recovery table to be narrowed down by specifying particular conditions. <ul style="list-style-type: none"> • [Color]: Filters the nozzles by color. "ALL" displays all ink colors and nozzles. • [Result]: Filters the nozzles by nozzle check results. "Abnormal" displays only the clogged nozzles. "ALL" displays all results. |
| 3 | Apply change | Updates the nozzle recovery registration with the changes made. |
| 4 | Clear | Clears the changes made to the nozzle recovery registration. |
| 5 | Nozzle recovery table | Displays the individual nozzle status for each color. <ul style="list-style-type: none"> • Abnormal nozzles are highlighted in orange. • Head line: Head row (horizontal direction on nozzle status image) • Nozzle line: Nozzle row (vertical direction on nozzle status image) • Nozzle No.: Nozzle number for each ink color • Status: Nozzle check results (normal/abnormal) |
| 6 | Scroll buttons | Used to scroll the nozzle recovery table. <ul style="list-style-type: none"> • : Jump 1,000 nozzles in the direction of the arrow. • : Jump 100 nozzles in the direction of the arrow. |

Print and register nozzle check pattern

The procedure for manual nozzle recovery registration is as follows:

- 1 From MENU on the touch panel, tap [Print].
- 2 Tap [Test pattern] > [User] > [Nozzle Check], then tap the job of the color for nozzle recovery.

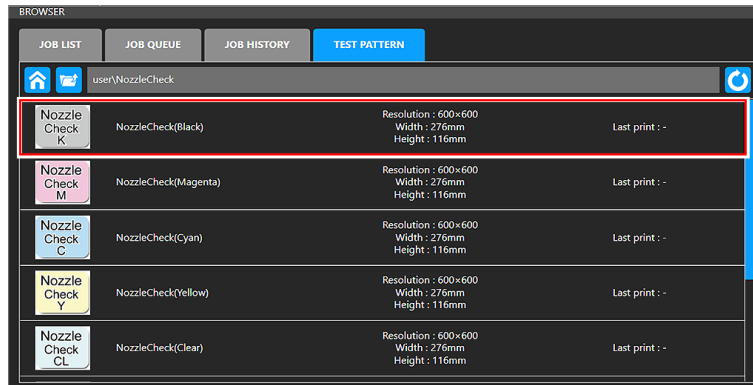

- 3 Tap [Print].
 - Print a nozzle check pattern.
 - Ink is ejected from all of the nozzles for the color selected.
- 4 Check the print results.
 - Check the nozzle numbers for the clogged nozzle locations.

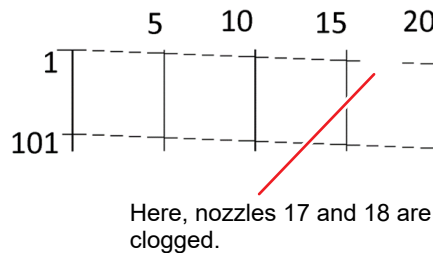

- 5 From MENU on the touch panel, tap [Maintenance].
 - The Maintenance menu is displayed.
- 6 Tap [Nozzle Recovery] > [Regist nozzle recovery].
 - A dialog box appears. ["Nozzle Recovery Registration Dialog"](#)(P. 113)

7 Update the nozzle recovery table with the print results.



(1) Set the filters as follows:

- [Color]: Color for nozzle recovery registration
- [Result] ALL

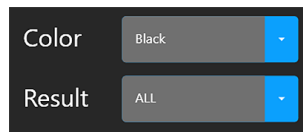

(2) Refer to the nozzle numbers for the clogged nozzle locations in the print results on the nozzle recovery table, then tap the [Status] row to set to [Abnormal].

- The text in the nozzles for which [Status] was changed turns yellow.

| | | | | |
|-------|---|---|----|----------|
| Black | 1 | 4 | 17 | Abnormal |
| Black | 1 | 6 | 18 | Abnormal |
| Black | 1 | 3 | 19 | Normal |

8 Tap [Apply change].

- A dialog box appears.
- To edit the change details, tap [Cancel].

9 Tap [Apply].

- The changes are applied.

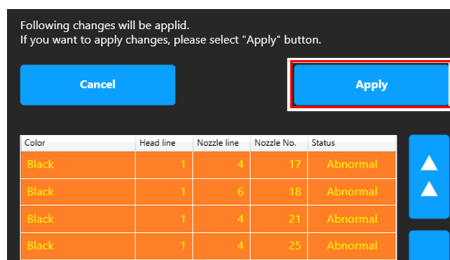



Important!

- The results for nozzles to which changes were applied in nozzle recovery registration will not be updated in subsequent nozzle checks. (Manual registration using nozzle recovery registration takes precedence.)
- To update nozzle check results, clear the nozzle recovery registration information. ["Nozzle Recovery Registration Dialog"\(P. 113\)](#)

3.4 Setting 1 Menu

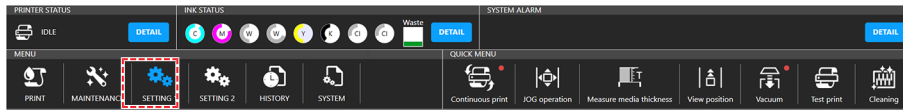
Set various print options.

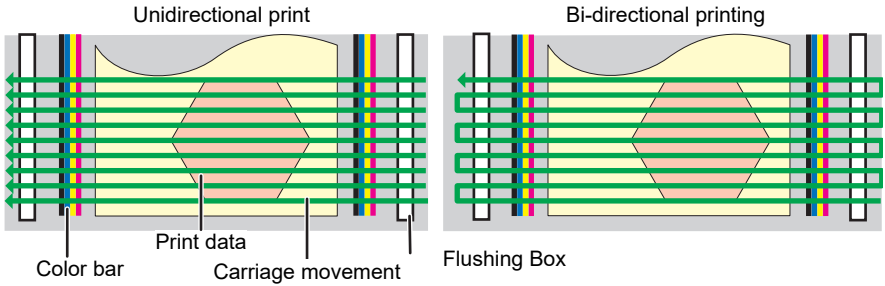
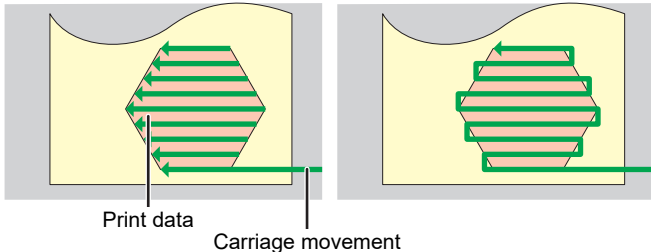

| Item | Overview |
|------------------------------|---|
| Print | Set print options. |
| Logical Seek | <p>Set the range of carriage movement.</p> <ul style="list-style-type: none"> Logical seek: Set the range of carriage movements. <ul style="list-style-type: none"> OFF: Machine size area  <ul style="list-style-type: none"> ON: Print data area  <p>Note: Refresh operations may cause the carriage to move to the flushing unit while printing is in progress.</p> |
| Refresh | <p>Reduces nozzle clogging by regularly discharging ink from the print heads.</p> <ul style="list-style-type: none"> Level: Choose higher numbers to discharge ink more often. |
| Ionizer | <p>Sets the ionizer (optional). For more information, refer to the operating manual for the ionizer.</p> |
| UV conditions | <p>Set the conditions for UV-LED lamp emission.</p> <ul style="list-style-type: none"> Assistance scan: Uses assistance scan when enabled (default is enabled).  "UV-LED Assistance Scan"(P. 91) |
| Select head | <p>Sets the head line used.</p> |
| Select head operation manual | <p>Displays the Select head operation manual.</p> |
| Machine motion | <p>Set print options.</p> |
| Work change | <p>Set post-printing operation.</p> <ul style="list-style-type: none"> Work change: Set to On to move the Y-bar to the view (evacuation) position and to turn the vacuum off. |
| Auto vacuum | <ul style="list-style-type: none"> Displayed only when the blower is connected. Set the vacuum strength. |
| MAPS* | <p>MAPS: Mimaki Advanced Pass System</p> |

| Item | Overview |
|--|---|
| | <ul style="list-style-type: none"> This function disperses the boundaries between passes to make feed streaks between passes less visible. Altering MAPS may alter the color. This function may be less effective with certain types of images. |
| MAPS preset 1 setting MAPS preset 2 setting MAPS preset 3 setting Default MAPS | Register a preset of your choice. <ul style="list-style-type: none"> Speed: Reducing speeds will make streaks less visible. However, printing will be slower. Smoothing: Increasing smoothing makes streaks less visible. Set your preferred preset from 1 to 3 as described above or set to Auto. This should normally be set to Auto. |
| UV illuminance | Set your preferred presets to be used for the UV illuminance setting on the print conditions screen. |
| Illuminance Preset1 setting Illuminance Preset2 setting Illuminance Preset3 setting Illuminance Preset4 setting Illuminance Preset5 setting Illuminance Preset6 setting Illuminance Preset7 setting Illuminance Preset8 setting | Set your preferred preset names and illuminance values to be displayed in the UV illuminance setting. (The Illuminance Preset1 to 3 settings are fixed and cannot be changed.) <ul style="list-style-type: none"> Preset name: Set your preferred preset name to be displayed on the setting screen. UV illuminance: Sets the illuminance value to be displayed when a preset is selected. |
| Default UV illuminance | The default UV illuminance displayed on the print conditions can be selected. |
| UV illuminance operation manual | Shows the UV illuminance guide. |
| Internal pattern | Set the print position for printed patterns used in test printing or for correcting the dot position. |
| Origin shift | <ul style="list-style-type: none"> Origin shift: Prints in the direction specified when set to ON. |

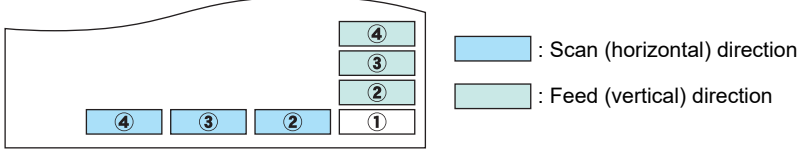
| Item | Overview |
|---------------------|---|
| | <ul style="list-style-type: none"> Origin shift direction: Set the print direction.  |
| Origin shift margin | <ul style="list-style-type: none"> Y margin: Sets the scan (horizontal) direction margin. X margin: Sets the feed (vertical) direction margin. |
| Feed Comp. | Set the feed offset. |
| Feed offset value | Enter the feed offset value. |
| Feed offset pattern | Print the feed offset pattern. |

Setting UV illuminance presets and default

Set your preferred presets and default to be used for the UV illuminance setting on the print conditions screen.

Setting the illuminance presets

You can set your preferred preset names and illuminance values to be displayed in the UV illuminance setting on the print conditions screen.

- 1 From MENU on the touch panel, tap [SETTING 1].
- 2 Tap [UV illuminance].

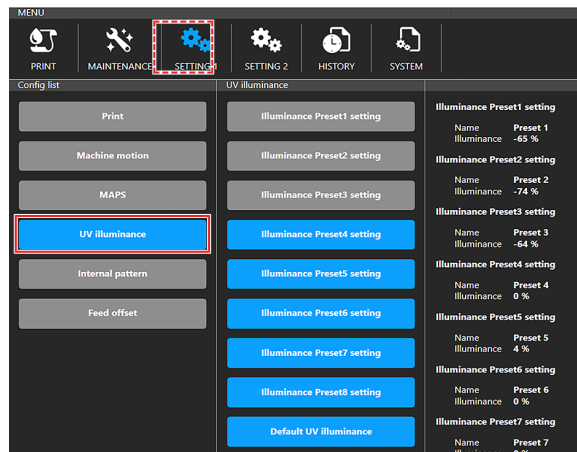

3 Tap the Illuminance Preset setting which you want to change from [Illuminance Preset4 setting] to [Illuminance Preset8 setting].

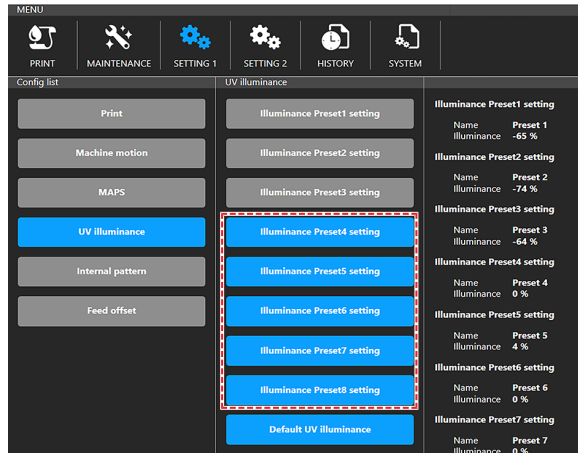



- A dialog box appears.

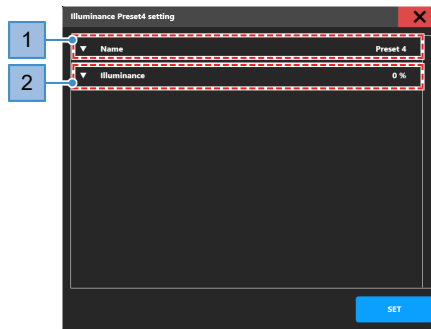

- [Illuminance Preset1 setting] to [Illuminance Preset3 setting] are fixed and cannot be changed.

4 Configure the settings.



| No. | Name | Overview |
|-----|----------------|--|
| 1 | Name | <p>Set your preferred preset name to be displayed in the UV illuminance setting on the print conditions screen.</p> <ul style="list-style-type: none"> • Tap the keyboard icon  to display the input screen. • Up to 16 characters can be entered. • The following names cannot be set. <ul style="list-style-type: none"> – Have no characters – Have only spaces – Same as other presets |
| 2 | UV illuminance | <p>Sets the illuminance value to be displayed when a preset is selected.</p> <ul style="list-style-type: none"> • Setting value: -100 to 50 % |

5 Tap [SET].

Default UV illuminance

The default UV illuminance displayed on the print conditions can be set.

1 From MENU on the touch panel, tap [SETTING 1].

2 Tap [UV illuminance] > [Default UV illuminance].

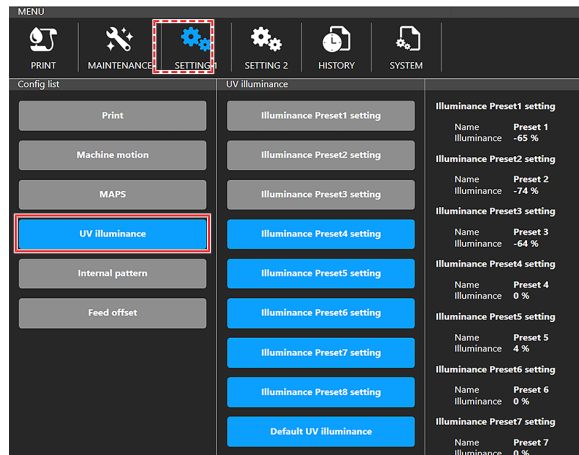

- A dialog box appears.

3 Tap [Auto] or select one of the presets.

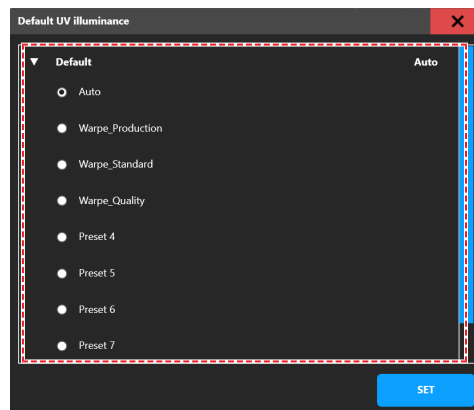

4 Tap [SET].

3.5 Setting 2 Menu

Set various operation-related settings.

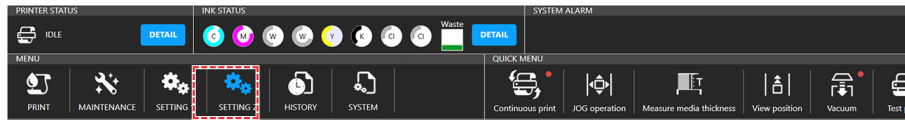

| Item | Overview |
|-------------------------------|--|
| Media | Set information about media. |
| JOG operation | Perform carriage operations and set media size and thickness. |
| Measure media thickness | Automatically measure media thickness. ☞ "Measuring Automatically"(P. 70) |
| Media origin | Enter the media origin position. |
| Media thickness / Head gap | Set the media thickness and head gap. ☞ "Entering Values Manually"(P. 71) ☞ "Setting the Head Gap"(P. 73) |
| View position | Set/move the Y-bar view (evacuation) position. |
| View position | Set the Y-bar evacuation position. |
| View position | Moves the view all the way to the rear, all the way to the front, or to another set position. |
| Toggle print | Sets toggle printing. ☞ "Setting the toggle print mode"(P. 56) |
| Bi-directional adjustment | When using bi-directional printing, correct the dot position.☞ "Correcting the Dot Position"(P. 80) |
| Bi-direction adjustment value | Check the printed pattern and enter correction values. |
| ***Pattern | Select the resolution and speed to correct, then print. Example: 600Std pattern, 600Hi pattern |
| System setting | Configure the system. |
| Languages | Change the touch panel display language. |
| Unit | Change the touch panel measurement unit. |
| Network setting | Set the network address. <ul style="list-style-type: none"> • Check IP address: Shows the machine's current IP address. • DHCP: Set to ON to use the IP address assigned by the DHCP server. |
| Automatic operation | Set to ON to enable automatic operation in conjunction with robots or other devices. |
| HotFolder setting | Set the number of jobs that can be stored in HotFolder. <ul style="list-style-type: none"> • Up to 100 jobs can be stored in HotFolder by default. • If the number of jobs stored in the HotFolder exceeds the set value, jobs are deleted in order with the oldest last print date first. |

3.6 History Menu

Shows the machine's maintenance history and other information.

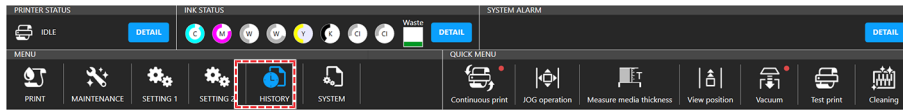

| Item | Overview |
|-------------|----------------------------------|
| Maintenance | Shows maintenance history. |
| Alarm | Shows the system alarm history. |
| Print | Shows the print history. |
| Controller | Shows the MPC operation history. |

3.7 System menu

Shows various information about the machine.

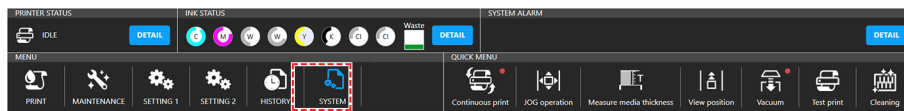

| Item | Overview |
|----------------------------|---|
| System information | Shows system information about the machine and control PC. |
| HDD disk space | Shows the disk space available on the control PC. |
| Machine information | Shows information about the machine. |
| Version | Shows the machine firmware version and MPC version. |
| Ink expired | Shows the ink expiration date. |
| Distance correction | Displays the correction value set for the machine. |
| License | Shows license information. |
| Tool | Executes the various tools. |
| Manual Log collection tool | Collects the machine operating logs and settings information manually. "Collecting Logs"(P. 174) |
| PICT Up | Displays PICT Up. |
| PICT Up update | Updates PICT Up. |
| Document | Shows the MPC user's guide and an error code list. |
| Operation manual | Shows the MPC user's guide. |
| Support Video Link | Displays the QR code used to view the support video. |
| Alarm list | Shows a list of error codes. |
| Service maintenance mode | This mode is exclusively for use by Mimaki representatives. |
| Power | Controls power to the machine and the control PC. "Power Supply"(P. 124) |
| Reset machine | Used if recovery fails even after a system reset |
| Reboot System | Used if recovery fails even after a machine reset. The control PC will restart. The system will take some time to start up. |
| Shutdown system | Shuts down the system. Turn off the main power supply. "Turning Off the Power"(P. 124) |

Power Supply

Do not turn off the main power supply for the machine or the power supply for the control PC. The control PC controls the machine. Turn off the power only for machine issues that cannot be resolved. Always restart after turning the power off.

Turning Off the Power

1 From [MENU] on the touch panel, tap [SYSTEM].

- This displays the system menu.

2 Tap [POWER] > [Shutdown System].

- The control PC shuts down.

3 Turn off the main power for the machine.

- The main power supply is located on the left side of the machine.

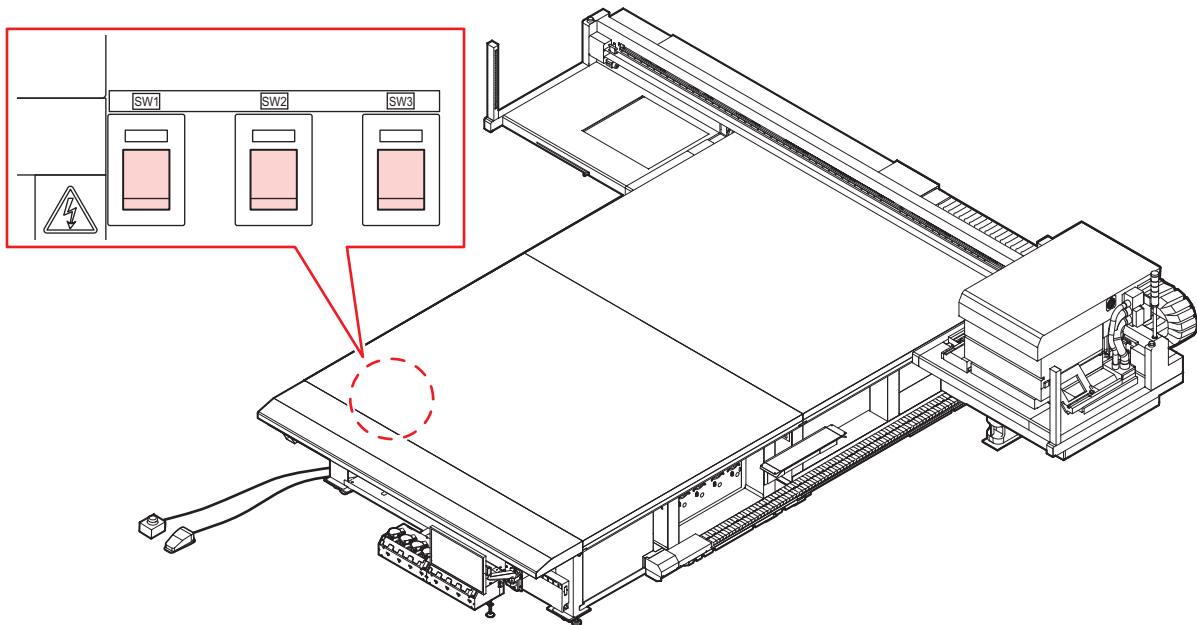

Turning On the Power

1 Set the machine's main power supply to the [I] side.

2 Turn on the control PC.

- This launches the MPC. The machine is ready to use.

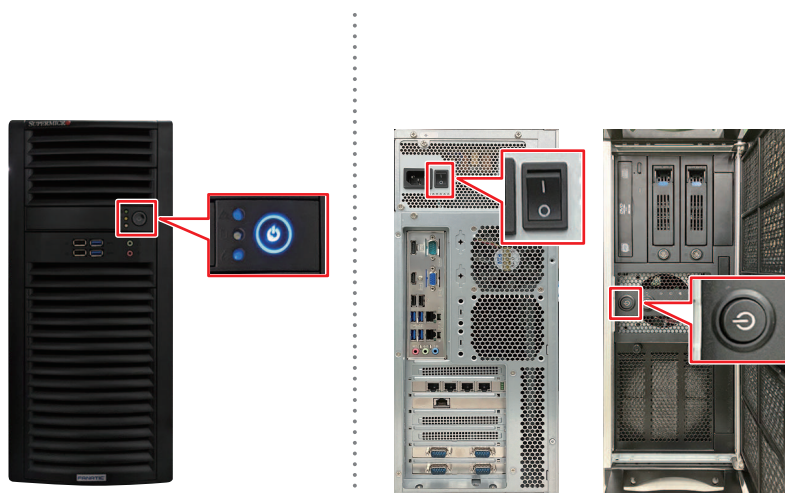

Chapter 4 Maintenance



This chapter

To ensure years of precise performance, maintain the machine periodically based on frequency of use.

Read the maintenance precautions thoroughly before maintaining this product.

| | | | |
|--|-----|--|-----|
| Maintenance Precautions | 128 | Consumable Item Replacement | 145 |
| Maintenance Timing | 129 | Wiper Replacement | 145 |
| Items Required for Maintenance | 129 | Carriage Filter Replacement | 146 |
| Performing Maintenance | 130 | Flushing Filter Replacement | 147 |
| Ink Maintenance | 130 | NCU Ink Pad Replacement | 147 |
| Wiper Cleaning | 130 | Bottle Ink Wipe Filter Replacement | 148 |
| Cap Rubber Cleaning | 132 | Waste Ink Tank Replacement | 149 |
| Station Area Cleaning | 132 | Refilling Cooling Water (Mixed With | |
| NCU Cleaning | 133 | Antifreeze) | 150 |
| Carriage Underside Cleaning | 134 | Bottle Cap Replacement | 152 |
| Waste Ink Draining Channel Cleaning | 136 | | |
| Table Cleaning | 137 | | |
| Exterior Cleaning (e.g., cover, Y-bar,) | 137 | | |
| Periodic Lubrication of the LM Blocks | 138 | | |

4.1 Maintenance Precautions



- This machine includes parts that must be replaced periodically. We therefore recommend taking out a maintenance contract. Carry out maintenance periodically and replace consumable items to prevent quality defects and accidents.

⚠ WARNING



- Clean periodically. Debris and dust will accumulate on electrical components when the machine is used for extended periods. There is a risk of failure, electric shock, or fire due to current leakage.
- Do not clean by blowing—e.g., avoid using air blowers. Doing so may lead to failure, electric shock, or fire involving the machine if airborne debris or dust gets inside electrical components. Wipe using a soft cloth soaked in diluted neutral detergent and thoroughly wrung out. A vacuum cleaner may also be used for cleaning.



- Be careful to prevent liquids from getting inside the table. Do not allow liquids to get inside the machine. Otherwise there is a risk of failure, electric shock, or fire.

⚠ CAUTION



- The UV-LED unit becomes extremely hot. Be careful not to touch the LED after it has been turned off until it has sufficiently cooled.



- For heavy soiling, wipe using a soft cloth soaked in diluted neutral detergent and thoroughly wrung out.



- Pay close attention to ventilation and be sure to wear safety glasses, gloves, and a mask when handling ink, maintenance liquid, waste ink, or other solutions used with the machine. Leaking ink may adhere to the skin or get into the eyes or mouth.



NOTICE



- Never touch the print head nozzle surface. Do not allow water or alcohol to come into contact with the print nozzle surface. This will increase the risk of machine failure or ejection failures (e.g., nozzle clogging or deflection).
- Do not use cotton swabs to clean around the head or carriage. Fibers from cotton swabs may adhere to the head nozzle surface and lead to ejection failures (e.g., nozzle clogging or deflection).
- Do not splash ink or maintenance liquid on the covers. Exposure to splashing ink or maintenance liquid may damage or deform the cover.
- Do not use benzene, thinner, or any chemical agent containing abrasives. Use of these chemicals may result in damage to or deformation of parts.
- Do not move the carriage by hand. To move the carriage, use the carriage out function on the menu.

4.2 Maintenance Timing

| Timing | Item |
|-----------------------------|---|
| At the end of the work day | Clean the wiper and wiper bracket. "Wiper Cleaning"(P. 130) |
| | Clean the wiper cleaner. "Wiper Cleaning"(P. 130) |
| | Clean the cap rubber. "Cap Rubber Cleaning"(P. 132) |
| | Clean the NCU. "NCU Cleaning"(P. 133) |
| | Clean the underside of the UV-LED lamp. "Carriage Underside Cleaning"(P. 134) |
| | Clean the underside of the carriage. "Carriage Underside Cleaning"(P. 134) |
| At the end of the work week | Clean the waste ink draining channel. "Waste Ink Draining Channel Cleaning"(P. 136) |
| | Clean the area around the station. "Station Area Cleaning"(P. 132) |
| | Clean the table. "Table Cleaning"(P. 137) |
| | Clean the cover and Y-bar. "Exterior Cleaning (e.g., cover, Y-bar,)" (P. 137) |
| | Check the waste ink levels in the waste ink tank. |
| Periodically | Shake the Ink bottle. "Ink Maintenance"(P. 130) |
| | Replace the ink bottle cap. "Bottle Cap Replacement"(P. 152) |

Items Required for Maintenance

To order replacement consumable items, contact your local dealer or our service office. For more information on consumable items, refer to our website. <https://mimaki.com/supply/inkjet.html>



- Do not store consumable items in locations where children may enter.

4.3 Performing Maintenance

Ink Maintenance

If ink constituents are sedimented, the ink density may become uneven. We recommend shaking the Ink bottle periodically to keep printing consistent.

UV ink: once a month.

White ink: once a day.

● Shaking the Ink bottle

1 Shake the Ink bottle to the left and right slowly at least 20 times.

- Tighten the ink bottle lid securely, then shake the bottle slowly from left to right to ensure that the ink moves inside, holding the ink bottle lid with a piece of recommended non-woven fabric.

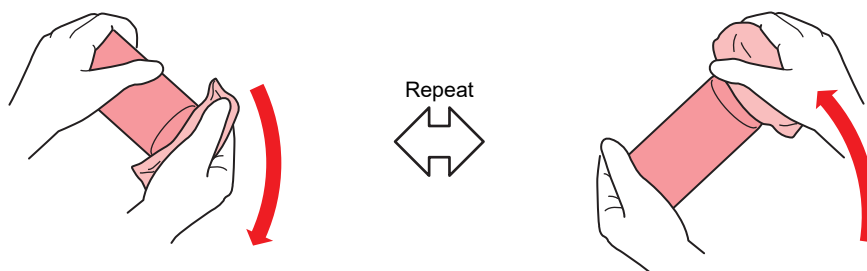

- Shake slowly. If the bottle is shaken too violently, ink may leak out or the air mixed in the ink may cause nozzle clogging.
- If the ink bottle is partially used, tilt it slowly until the ink bottle is upright.

Wiper Cleaning

The wiper wipes off ink adhering to the print head nozzle surface. Continuing to use the dirty wiper may cause the wiper to which dried ink and dust are attached to rub against the nozzle surface, leading to printing defects (e.g., nozzle clogging or deflection).



- Be careful to avoid leaving fragments from the cleaning stick behind when cleaning. These fragments will increase the risk of ejection failures (e.g., nozzle clogging or deflection).

1 From MENU on the touch panel, tap [MAINTENANCE].

- The Maintenance menu is displayed.

2 Tap [Daily maintenance] > [Daily station maintenance].

- The carriage moves over the table.

3 Remove the wiper.

- Hold the lugs on both sides of the wiper bracket, then pull out the wiper.

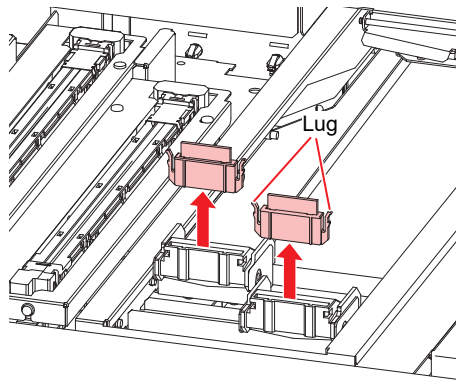

4 Clean the wiper and bracket.

- Wipe off any ink and dust adhering using a cleaning stick moistened with maintenance liquid. Wipe off the maintenance liquid. Make sure none remains.

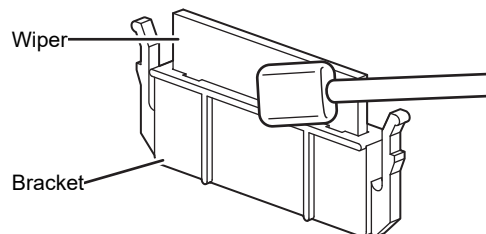

- Replace dirty or warped wipers with new ones. 🖱️ ["Wiper Replacement"\(P. 145\)](#)

5 Clean the wiper cleaner.

- Wipe off any ink and dust adhering using a cleaning stick moistened with maintenance liquid. Wipe off the maintenance liquid. Make sure none remains.

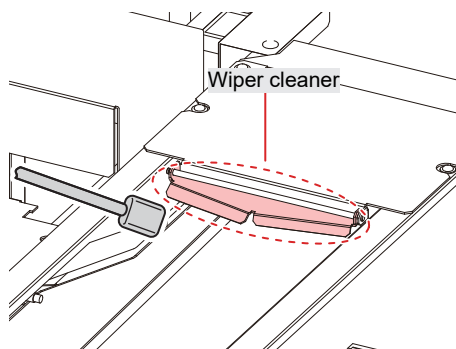

6 Reattach the wiper at the original position.

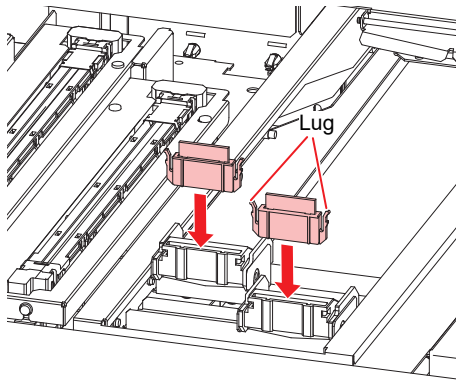

7 Tap [Complete] > [Finish] once cleaning is complete.

Cap Rubber Cleaning

The cap rubber keeps the print head nozzle surface from drying out. Continuing to use a dirty cap may affect ink take-up and lead to ejection failures (e.g., nozzle clogging, deflection).



- Be careful to avoid leaving fragments from the cleaning stick behind when cleaning. These fragments will increase the risk of ejection failures (e.g., nozzle clogging or deflection).

1 From MENU on the touch panel, tap [MAINTENANCE].

- The Maintenance menu is displayed.

2 Tap [Daily maintenance] > [Daily station maintenance].

- The carriage moves over the table.

3 Clean the cap rubber.

- Wipe off any ink and dust adhering using a cleaning stick moistened with maintenance liquid. Wipe off the maintenance liquid. Make sure none remains.

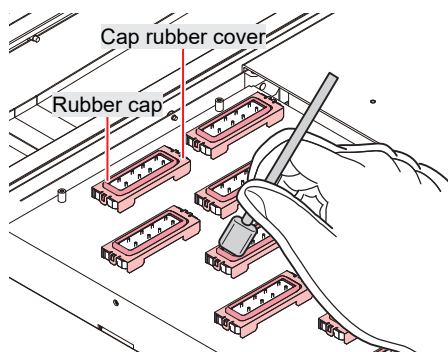

4 Tap [Complete] > [Finish] once cleaning is complete.

Station Area Cleaning

Continued use when dirty may prevent ink from flowing into the waste ink tank or cause dried ink and attached dust to rub against the head nozzle surface, leading to ejection failures (e.g., nozzle clogging, deflection).

1 From MENU on the touch panel, tap [MAINTENANCE].

- The Maintenance menu is displayed.

2 Tap [Weekly maintenance] > [Weekly station maintenance].

- The carriage moves over the table.

3 Clean the wiper tray.

- Wipe off any ink and dust adhering using a cleaning stick moistened with maintenance liquid. Wipe off the maintenance liquid. Make sure none remains.
- Scrape off any dried ink with a spatula or similar tool.

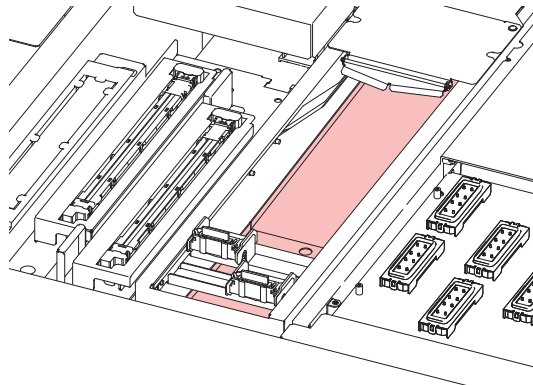
**4** Clean around the flushing filter and on the shutter surface.

- Wipe off any ink and dust adhering using a cleaning stick moistened with maintenance liquid. Wipe off the maintenance liquid. Make sure none remains.
- Scrape off any dried ink with a spatula or similar tool.

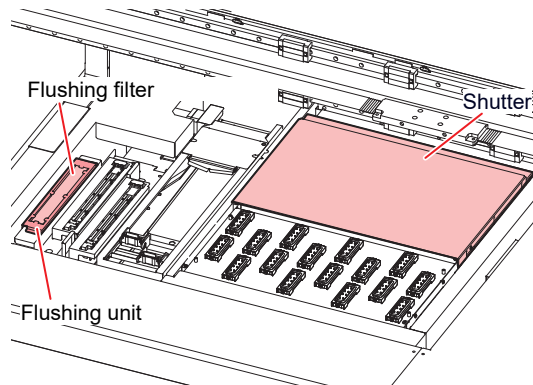

- If the flushing filter is exceptionally dirty, replace it with new one. 🖱️ ["Flushing Filter Replacement"\(P. 147\)](#)

5 Tap [Complete] > [Finish] once cleaning is complete.**NCU Cleaning**

The NCU uses a sensor to monitor the ink droplets ejected from the print head nozzles. Continuing to use the dirty NCU may prevent the nozzle check function from operating correctly.



- Be careful to avoid leaving fragments from the cleaning stick behind when cleaning. These fragments will increase the risk of ejection failures (e.g., nozzle clogging or deflection).

- 1** From **MENU** on the touch panel, tap **[MAINTENANCE]**.
 - The Maintenance menu is displayed.
- 2** Tap **[Daily maintenance]** > **[Daily station maintenance]**.
 - The carriage moves over the table.
- 3** Clean the NCU.
 - Wipe off any ink and dust adhering using a cleaning stick moistened with maintenance liquid. Wipe off the maintenance liquid. Make sure none remains.

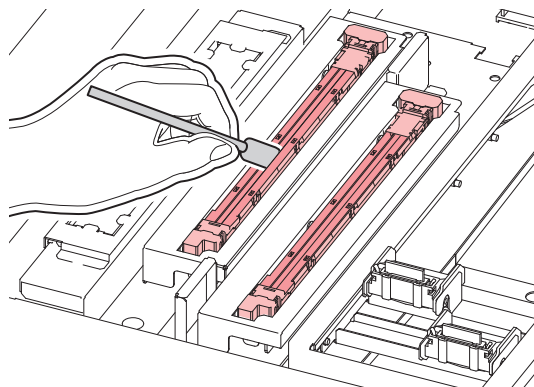

- Insert the cleaning stick as far as the line shown in the illustration.

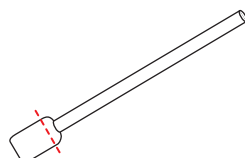

- 4** Tap **[Complete]** > **[Finish]** once cleaning is complete.

Carriage Underside Cleaning

The underside of the carriage becomes coated with ink wiped off by the wiper. Continuing to use the dirty carriage underside will rub dried ink and attached dust on to the media, resulting in contaminated prints.

The print head uses an extremely delicate mechanism. Take great care when handling it.



- Be careful to avoid leaving fragments from the cleaning stick behind when cleaning. These fragments will increase the risk of ejection failures (e.g., nozzle clogging or deflection).

- 1** From **MENU** on the touch panel, tap **[MAINTENANCE]**.
 - The Maintenance menu is displayed.
- 2** Tap **[Daily maintenance]** > **[Head maintenance]**.
 - The carriage moves to the maintenance space.

3 Slide the maintenance cover on the left side of the Y-bar.

- Lift the lever and slide it to the left.

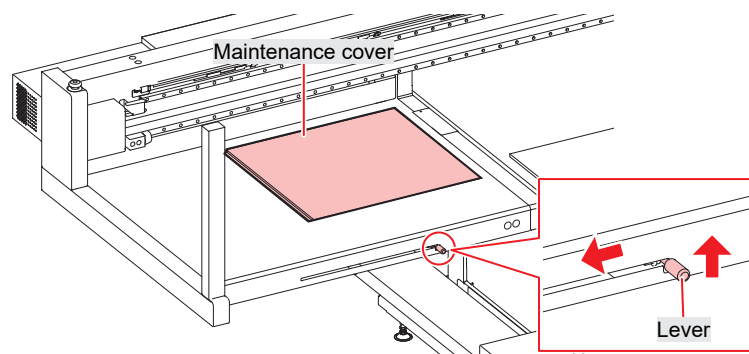

4 Clean the UV-LED lamp.

- Wipe off any ink and dust adhering using a cleaning stick moistened with maintenance liquid. Wipe off the maintenance liquid. Make sure none remains.

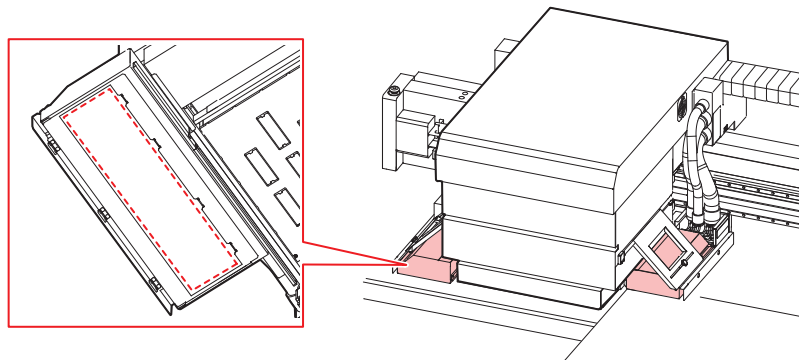

- Do not use excessive force when rubbing the UV-LED lamp with a cleaning stick. The UV-LED lamp may be damaged.

5 Clean around the print head.

- Wipe off any ink and dust adhering using a cleaning stick moistened with maintenance liquid. Wipe off the maintenance liquid. Make sure none remains.

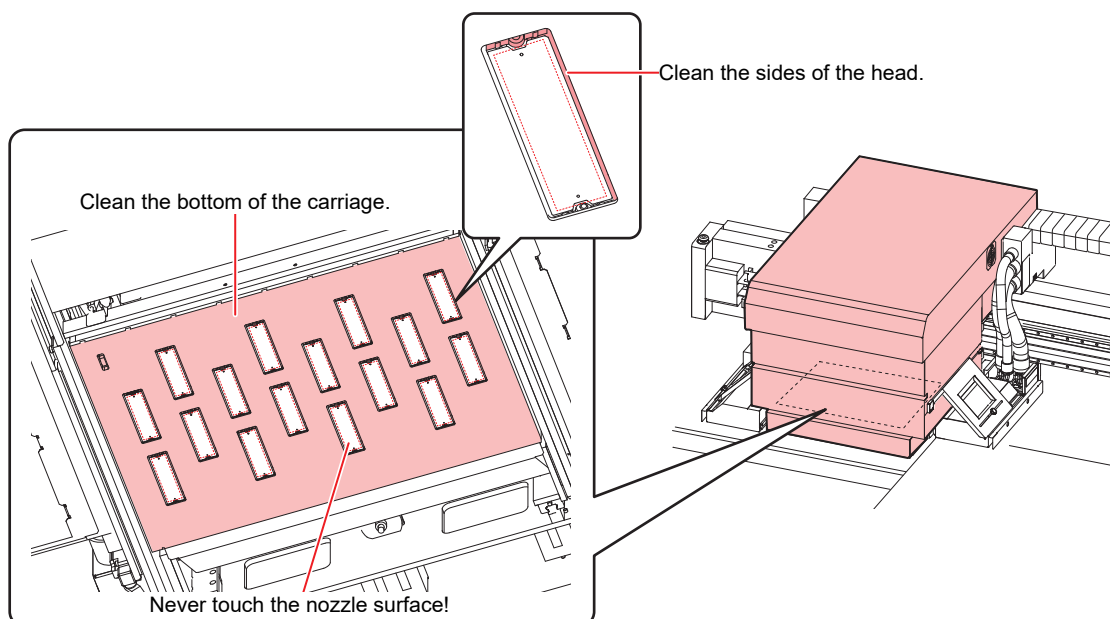



- Never touch the print head nozzle surface.

- 6** Once cleaning is complete, slide the maintenance cover on the left side of the Y-bar to close it.

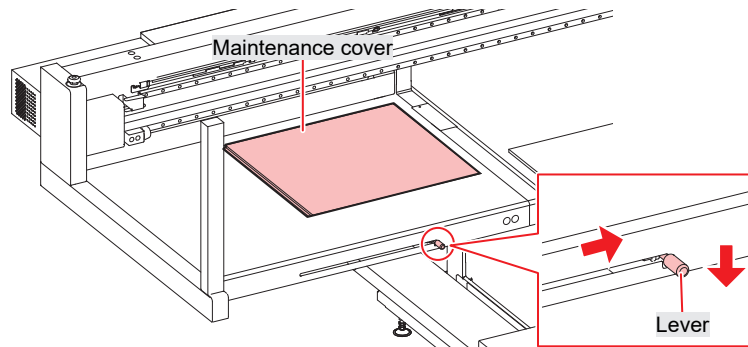

- Make sure the maintenance cover is returned to the correct position.

- 7** Tap [Complete] > [Finish].

Waste Ink Draining Channel Cleaning

Clean the ink discharge channel regularly to prevent clogging of the ink discharge channel below the cap.

- 1** From MENU on the touch panel, tap [MAINTENANCE].
 - The Maintenance menu is displayed.
- 2** Tap [Weekly maintenance] > [Clean ink discharge path].
 - The carriage moves over the table.
 - The suction pump will start operating.
- 3** Apply maintenance liquid to the caps.
 - Use a syringe to draw up and apply maintenance liquid to the caps.

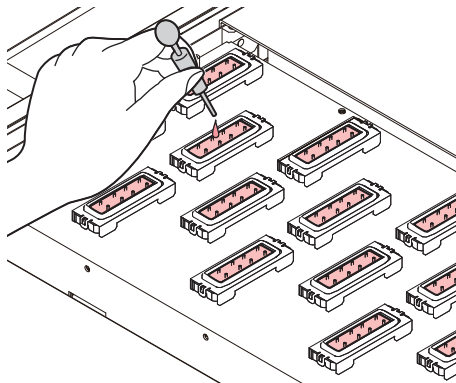

- 4** Tap [Complete].
 - Maintenance liquid is discharged from the pump tube (waste ink draining channel below the cap). The carriage returns to the station.

Table Cleaning



- Turn off the main power supply before carrying out maintenance.

Continuing to use while dirty will cause dried ink and attached dust to rub against the head nozzle surface, and lead to ejection failures (e.g., nozzle clogging or deflection).

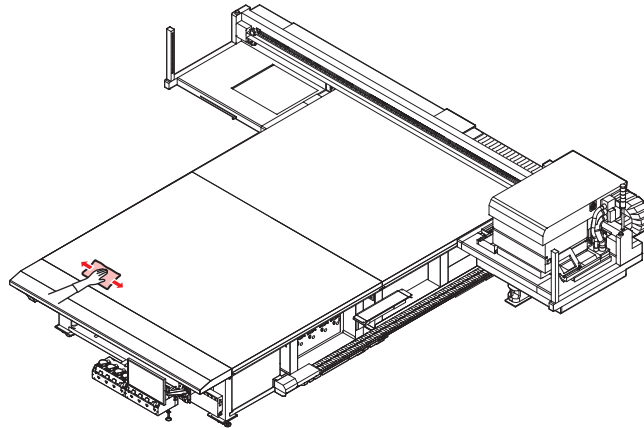

- Do not use organic solvents such as acetone to clean the table. These may damage the table. If the table becomes damaged, it cannot be repaired on-site.



- Be careful to prevent liquids from getting inside the table. Do not allow liquids to get inside the machine. Otherwise there is a risk of failure, electric shock, or fire.



- If you have to use IPA or ethanol to clean off ink or color transfers from the table surface, lightly dampen a soft cloth or paper towel with a small amount of the organic solvent, then wipe it off. Exercise extreme care to ensure that no organic solvent seeps inside the table.
- Remove debris and solidified ink frequently using a soft brush, dry cloth, or paper towel.
- For heavy soiling, wipe using a soft cloth soaked in diluted neutral detergent and thoroughly wrung out.
- Areas such as the table grooves and screw holes are particularly susceptible to dirt buildup, and should be cleaned frequently.
- Solidified ink on surfaces can be removed using a spatula, but care must be taken to avoid scratches.

Exterior Cleaning (e.g., cover, Y-bar,)



- Turn off the main power supply before carrying out maintenance.

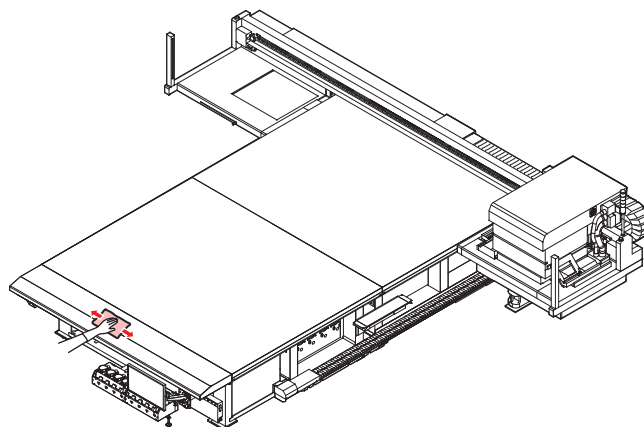



- For heavy soiling, wipe using a soft cloth soaked in diluted neutral detergent and thoroughly wrung out.



- Be careful to prevent liquids from getting inside the table. Do not allow liquids to get inside the machine. Otherwise there is a risk of failure, electric shock, or fire.

LM Guide

Wipe off dust from the left and right ends of the LM guide surface with a soft dry cloth.

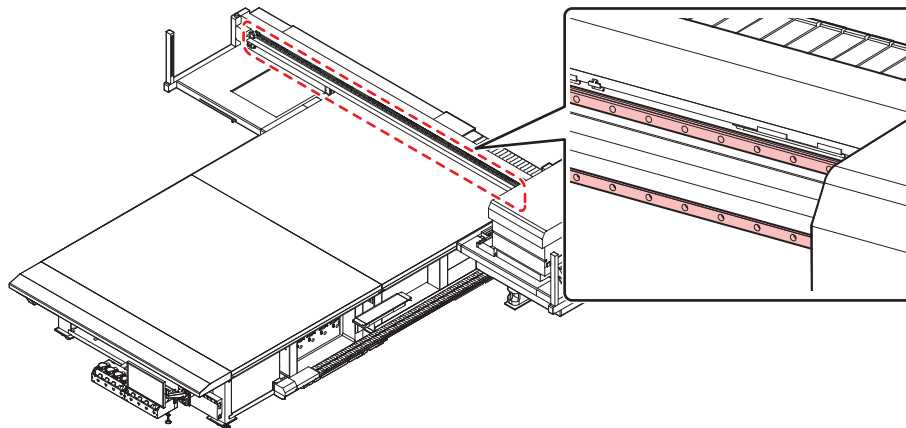

- The LM guide is lubricated. Never wipe with solvents such as ethanol. Wipe off any excess or dripping lubricant with a soft dry cloth.

Periodic Lubrication of the LM Blocks



- The LM blocks should be lubricated when "Lubricate the LM guide block" appears in SYSTEM ALARM on the MPC.

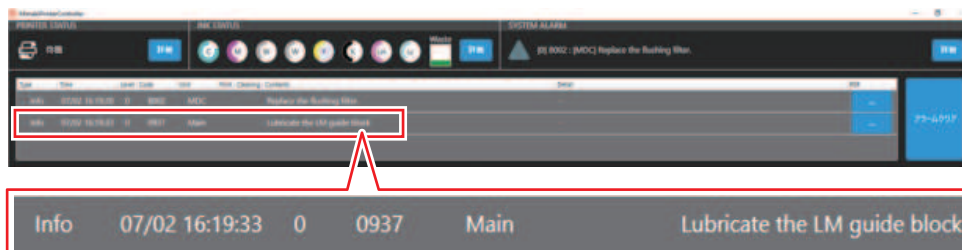

- The frequency with which the alarm is displayed is generally determined by the distance traveled by the machine, but this depends on the machine usage. (Distance of 450 km: Equivalent to approx. 2 years)



- The grease gun is provided in accessory box 2. The items included are as shown below. Either the KTC CG-400 or Yamada Corporation CH-400 is provided.



- [Required tools]
 - (1) Grease gun (CG-400 or CH-400)
 - (2) Hydro chuck nozzle (HSP-2)
 - (3) Grease (Alvania Grease: EP2 or Gadus S2V220 2)
 - (4) Gloves

Using the grease gun

A grease gun is used to grease the LM blocks. Be sure to read the grease gun usage instructions before greasing.



- The grease gun is provided in accessory box 2. The items included are as shown below. Either the KTC CG-400 or Yamada Corporation CH-400 is provided.



- (1) Grease gun (CG-400 or CH-400)
- (2) Hydro chuck nozzle (HSP-2)
- (3) Instruction Manual



- The grease gun is also required for user maintenance. Refer to Operation Manual > Maintenance > [Periodic Lubrication of the LM Block], and explain to the customer how to use the grease gun.

● Usage procedure

1 Attach the hydro chuck nozzle to the grease gun.



2 Load the grease (400 g cartridge) into the grease gun.

(1) Remove the grease gun head.



(2) Insert the grease cartridge.

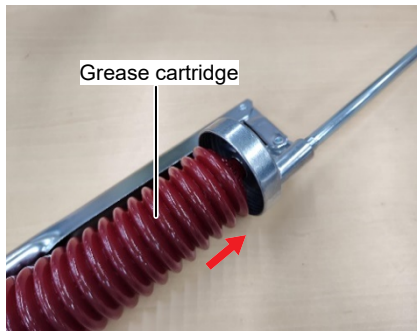

(3) Slide back the grease case.





- When mounting the grease in the cartridge case, pull the chain ring and secure the chain lock.

Release the chain lock when in use.



Chain ring



Chain lock groove

- 3** Push the grease gun nozzle up vertically against the lubrication point, then pull the handle to dispense the grease.

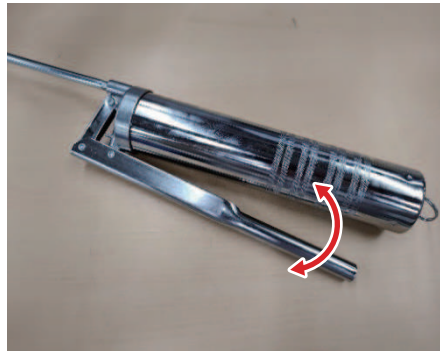

Lubrication procedure

1 Open the maintenance wizard in the MPC.

- (1) Opening using [Maintenance] > [Other maintenance] > [Grease up X-LM block]

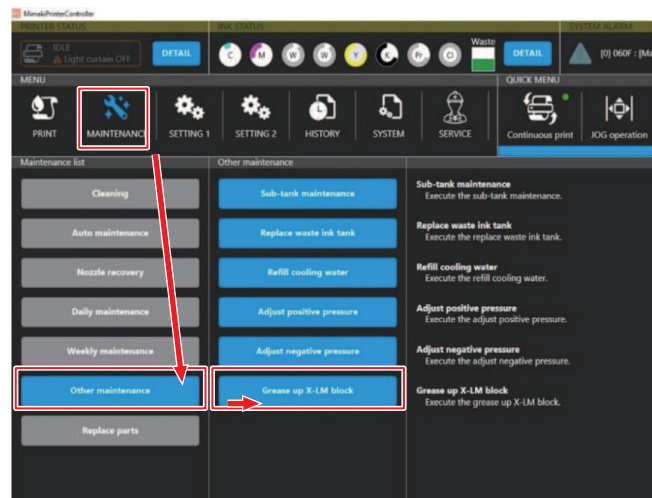

- (2) Opening the wizard from a notification message

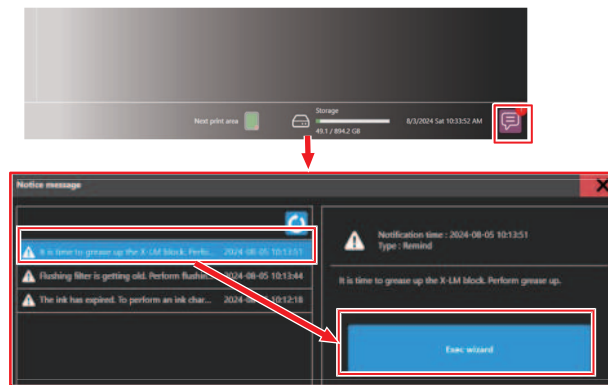

2 Tap [OK] in the window displayed.

- The carriage moves all the way to the rear. Once the carriage has moved all the way to the rear, a window is displayed with the greasing instructions.

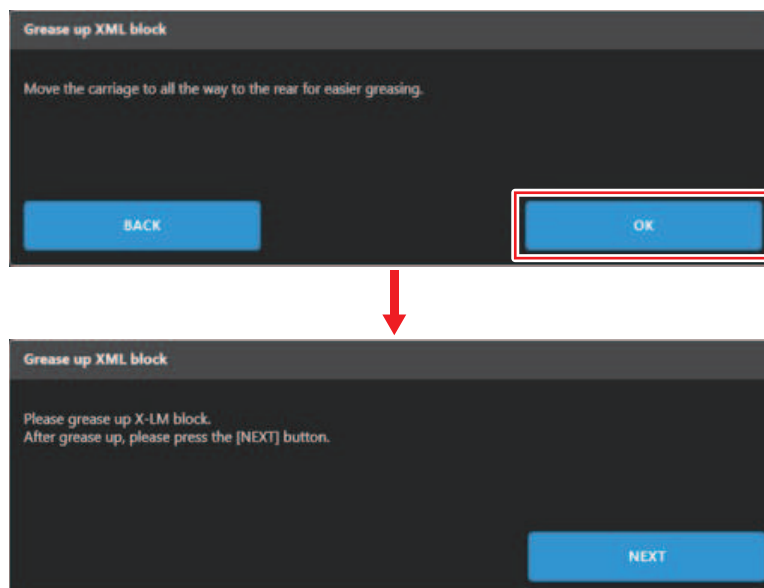

3 Check to confirm that this is the greasing window, then lubricate the four LM blocks.

LM block mounting positions

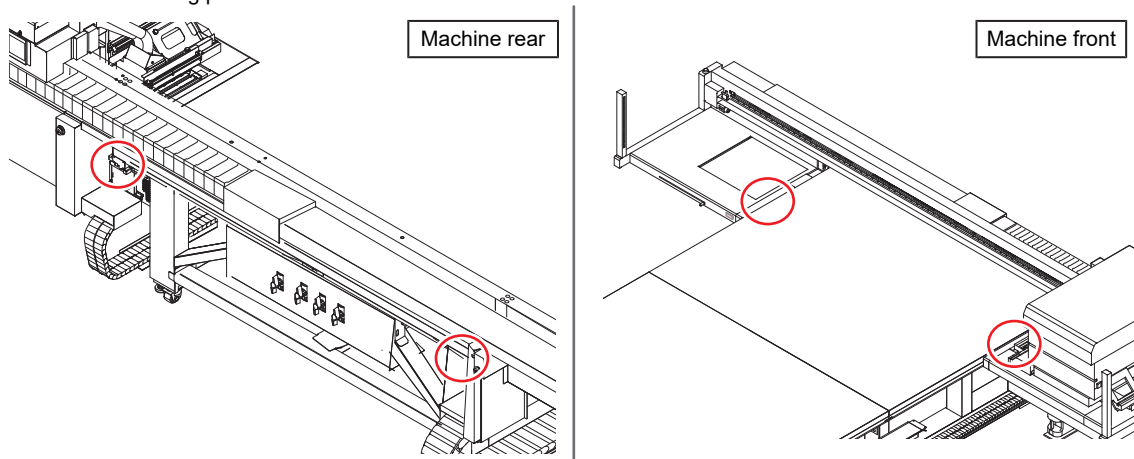

- Push the grease gun on to the grease nipples to lubricate. (Greasing guide: 2 pushes)

Important!

- Wipe away any grease that overflows from the LM blocks after two pushes.

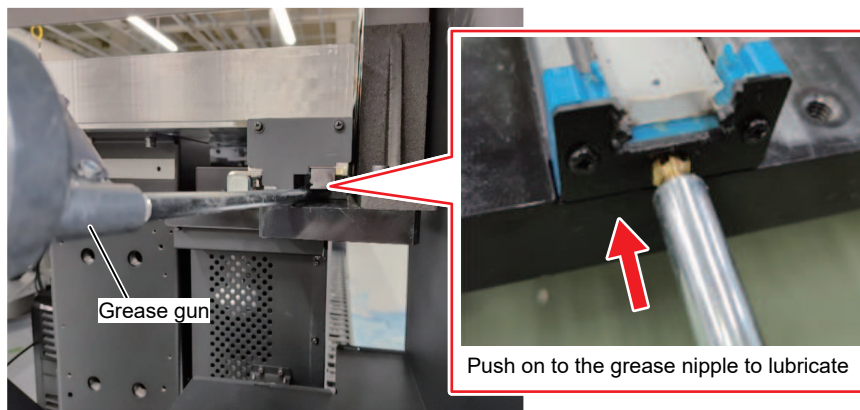
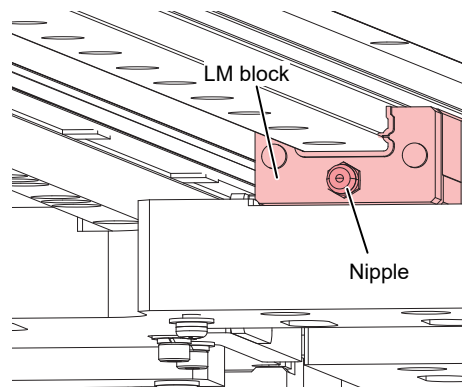

4 Once greasing at the rear of the machine is complete, select [Next] on the MPC operating panel.

- A confirmation dialog is displayed for moving the carriage all the way to the front.



- Check to confirm that there are no obstructions on the route for moving the carriage all the way to the front.

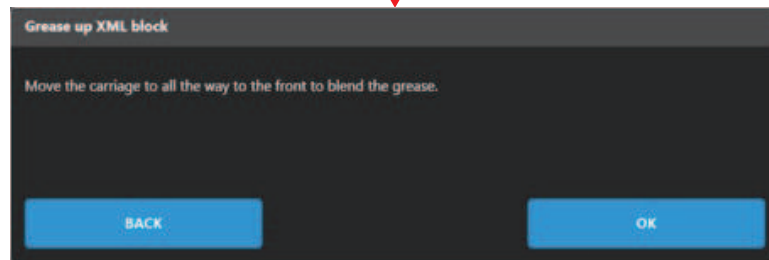
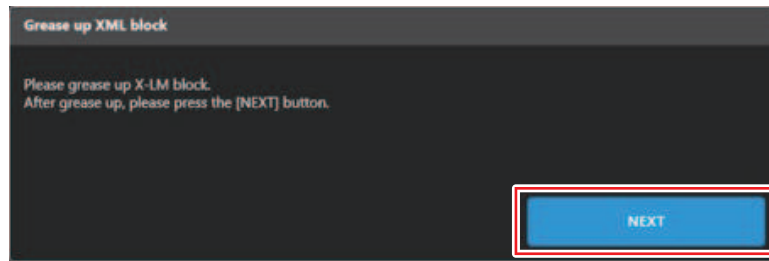

5 Check to confirm that there are no obstructions, then tap [OK].

- The carriage automatically moves to the front. (This takes about 30 seconds.)

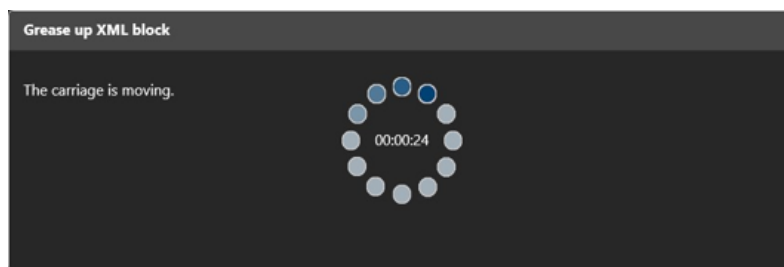

6 Once the carriage has moved all the way to the front and the following appears, tap [OK].



4.4 Consumable Item Replacement

To order replacement consumable items, contact your local dealer or our service office.

For more information on consumable items, refer to our website. <https://mimaki.com/supply/inkjet.html>



- Do not store consumable items in locations where children may enter.



- When disposing of consumable items, contact an industrial waste disposal operator or dispose of in accordance with local laws and regulations.

Wiper Replacement

The machine maintains a count of the number of wiping cycles. Once the specified value is reached, "0605 REPLACE WIPER" will appear in SYSTEM ALARM on the touch panel. Replace dirty or warped wipers with new ones.

- 1 From MENU on the touch panel, tap [MAINTENANCE].**
 - The Maintenance menu is displayed.
- 2 Tap [Replace parts] > [Replace wiper].**
 - The carriage moves over the table.
- 3 Remove the wiper.**
 - Hold the lugs on both sides of the wiper bracket, then pull out the wiper.

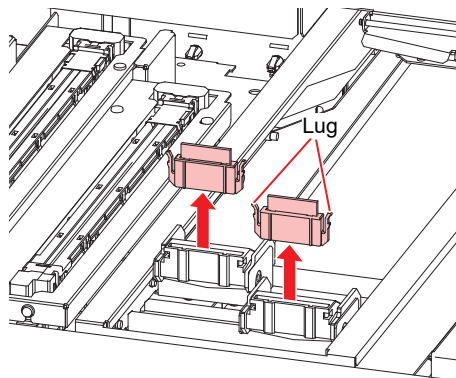

- 4 Clean the wiper cleaner.**
 - "Wiper Cleaning"(P. 130)

5 Mount a new wiper.

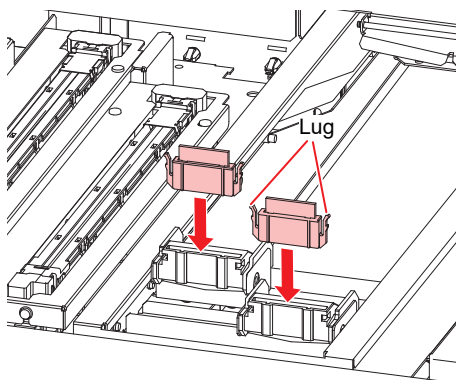

6 Tap [Complete] > [Finish] once replacement is complete.

- The wiper usage count is reset.

Carriage Filter Replacement

Check the mist filters and replace if very dirty.



- Turn off the main power supply before carrying out maintenance.

1 Remove the carriage filter covers.

- Remove the screws, then remove the filter covers.

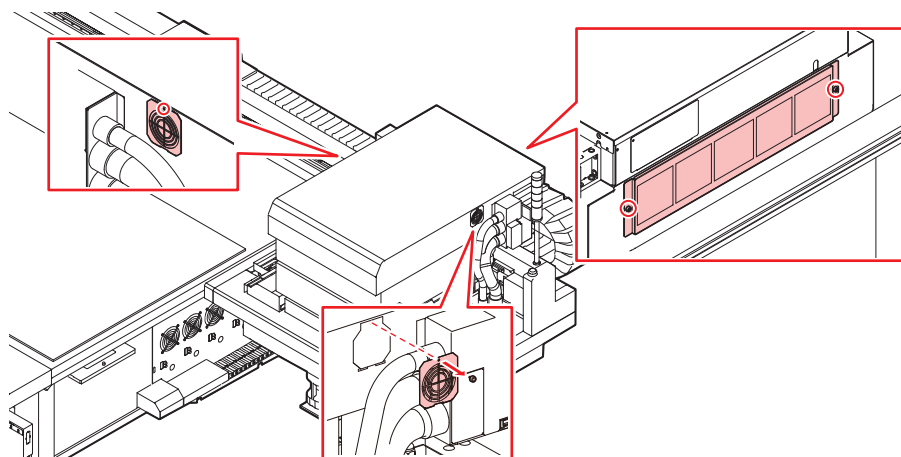

- Filters are positioned on the left, right, and back of the carriage.

2 Install new filters.

3 Install the filter covers.

- Left and right of carriage: Fit the tabs on the bottom of the filter cover to the carriage cover, then secure with screws.
- Back of carriage: Be careful to avoid dropping the filter cover.

Flushing Filter Replacement

The machine counts the amount of ink used in flushing. When a specified value is reached, SYSTEM ALARM will appear on the touch panel. Use this as a guide for replacing the flushing filter.

1 From MENU on the touch panel, tap [MAINTENANCE].

- The Maintenance menu is displayed.

2 Tap [Replace parts] > [Replace flushing filter].

- The carriage moves over the table.

3 Remove the flushing filter.

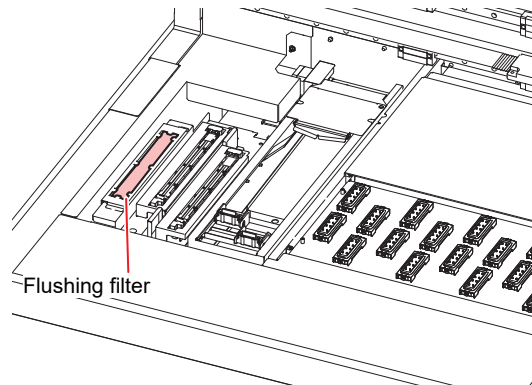

4 Clean around the flushing filter.

-  ["Station Area Cleaning"\(P. 132\)](#)

5 Install a new flushing filter.

6 Tap [Complete] > [Finish] once replacement is complete.

- This resets the ink flushing amount.

NCU Ink Pad Replacement

If the NCU ink pad must be replaced, "0657 Check NCU waste ink" will appear in SYSTEM ALARM on the touch panel. Use this as a guide for replacement.

1 From MENU on the touch panel, tap [MAINTENANCE].

- The Maintenance menu is displayed.

2 Tap [Replace parts] > [Replace NCU absorbent].

- The carriage moves over the table, and the station rises.

3 Remove the NCU ink-receiving pan.

- Slide forward to remove.

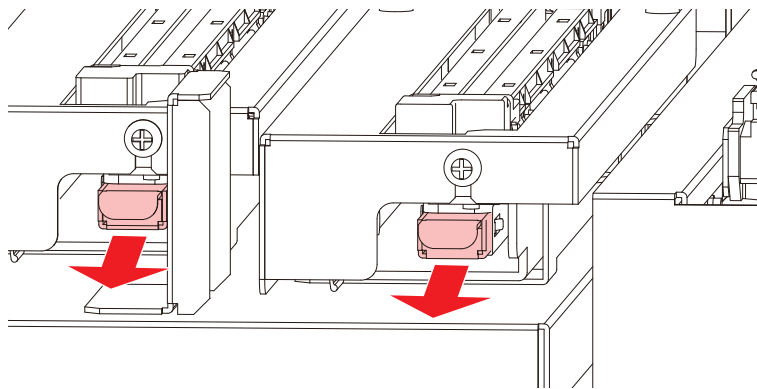

4 Remove the ink pad from the NCU ink-receiving pan.

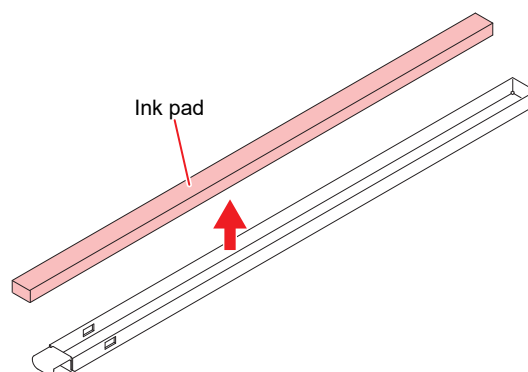

5 Clean the NCU ink-receiving pan.

6 Install a new NCU ink pad.

7 Install the NCU ink-receiving pan.

- Insert until it clicks into place, and confirm that the tabs are engaged.

8 Tap [Complete] > [Finish] once replacement is complete.

- This resets the NCU ink pad count.

Bottle Ink Wipe Filter Replacement

Check the bottle ink wipe filters and replace if very dirty.

1 Remove the wipe filters.

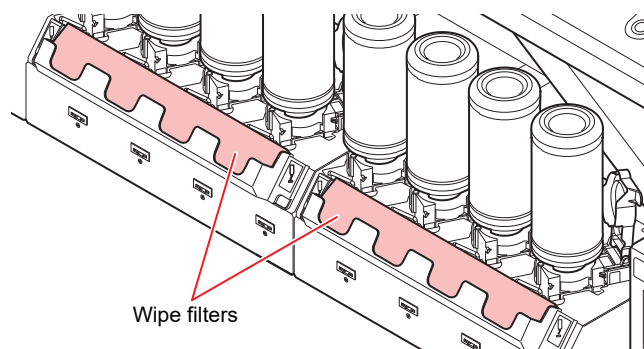

- 2 Clean the wipe filter case.
- 3 Install new wipe filters.

Waste Ink Tank Replacement

Ink used during head cleaning and other processes is collected in the waste ink tank at the lower right of the machine.

The machine uses a sensor to monitor the waste ink tank weight. When the weight sensor reacts, "0666 WASTE INK TANK FULL" will appear in SYSTEM ALARM on the touch panel. If this alarm appears, replace the waste ink tank. The machine also counts the amount of ink discharged. Once the discharge amount reaches a specified value, "0604 CHECK WASTE BOTTLE" will appear in SYSTEM ALARM on the touch panel. Use this a guide for replacing the waste ink tank.



- For a 2.6-liter tank, the preset level is 80% (2.1 liters).
- Continuing to use the product without disposing of the waste ink may result in waste ink overflowing from the waste ink tank. Although the machine uses a sensor to detect the waste ink amount, and displays the message prompting to replace the waste ink tank, visually check ink levels in the waste ink tank about once a week.



- Pay close attention to ventilation and be sure to wear safety glasses, gloves, and a mask when handling ink, maintenance liquid, waste ink, or other solutions used with the machine. Leaking ink may adhere to the skin or get into the eyes or mouth.



Replacing the Waste Ink Tank

- 1 From MENU on the touch panel, tap [MAINTENANCE].
 - The Maintenance menu is displayed.
- 2 Tap [Other maintenance] > [Replace waste ink tank].
- 3 Open the waste ink tank guard.
 - Remove the screw to open the waste ink tank guard.

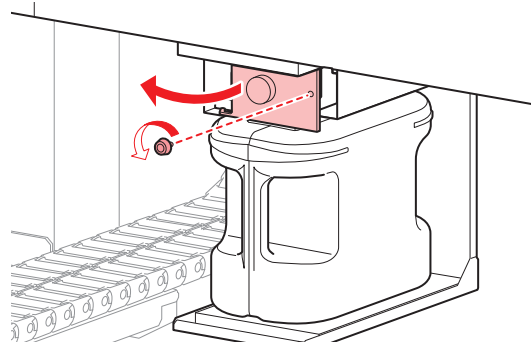

4 Grasp the handle of the waste ink tank and slide out.

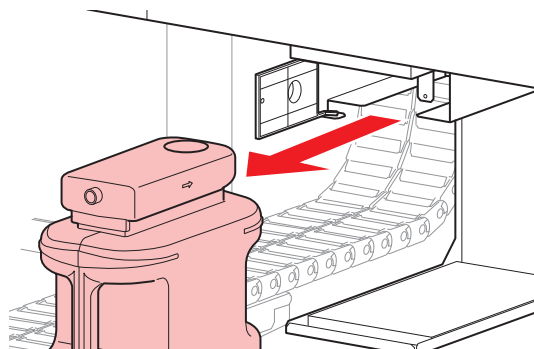

5 Attach the cap to the removed waste ink tank, and use tape to prevent leakage of waste ink.

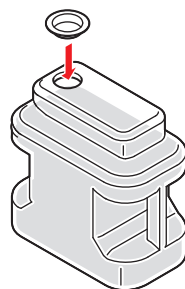

- When disposing of ink, maintenance liquid or other liquid used with the product, or containers or non-woven fabric contaminated with ink or other liquid, contact an industrial waste disposal operator or dispose of the product in accordance with the local laws and regulations.

6 Install a new waste ink tank.

7 Close the waste ink tank guard.

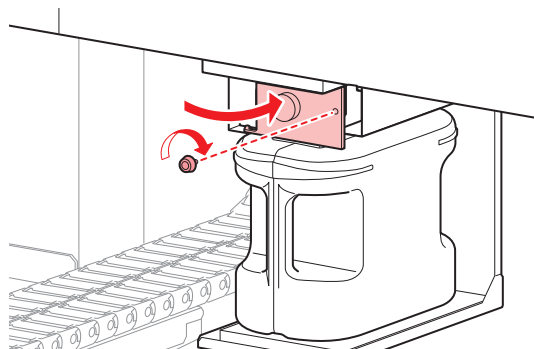

8 Tap [Complete] > [Finish] once replacement is complete.

- The waste ink level will be reset.

Refilling Cooling Water (Mixed With Antifreeze)

The UV-LED unit will become hot with use. Cooling water (mixed with antifreeze) is used to cool this unit. Once the specified value is reached, "0705 WATER LACK" will appear in SYSTEM ALARM on the touch panel, and a buzzer will sound. Refill the cooling unit tank with cooling water mixed with antifreeze (1 part antifreeze to 2 parts water). Filling requires about 830 ml of the antifreeze mixture per tank.



- Use only genuine Mimaki Engineering anti freezing liquid. Use of other anti freezing liquid may cause failures of the cooling unit.
- Take care to prevent any potential sources of ignition such as sparks caused by static electricity or material impacts.
- Be sure to dispose of any unneeded anti freezing liquid in the following manner.
 - (1) Soak it up with materials such as sawdust or rags and burn them in an incinerator.
 - (2) Pass them onto a licensed industrial waste disposal company after clearly indicating their contents.

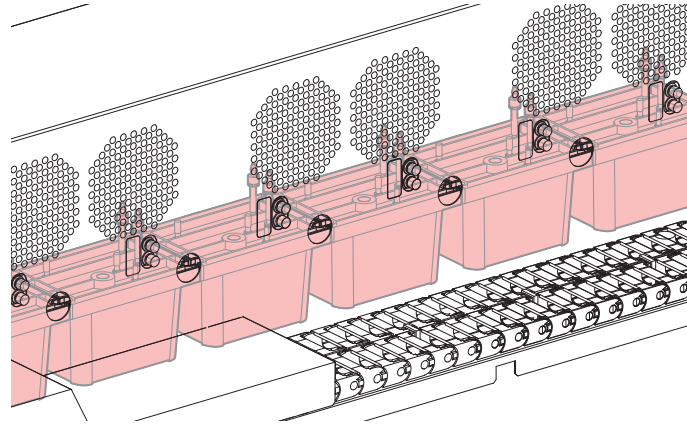

1 Combine 1 part antifreeze to 2 parts water in the container (provided).



- Antifreeze mixture precautions
 - (1) Be sure to use water that satisfies the following conditions.
 - Calcium content: Not exceeding 10 mg/L (1 mg/100 ml)
 - Hardness: Not exceeding 60 mg/L
 - Distilled or purified water
 - (2) Do not use antifreeze mixture that has been prepared far in advance.
 - (3) Any excess antifreeze mixture must be used within one week. Filling the machine with antifreeze mixture that has been prepared more than one week in advance may lead to a malfunction.

2 Transfer the antifreeze mixture to the syringe (provided).



3 From MENU on the touch panel, tap [MAINTENANCE].

- The Maintenance menu is displayed.

4 Tap [Other maintenance] > [Refill cooling water].

- A dialog box appears.



- During touch panel operation, the Y-bar will move to the front of the table. Do not approach the machine until the Y-bar has come to a complete stop.

5 Remove the caps for water supply and air purging.

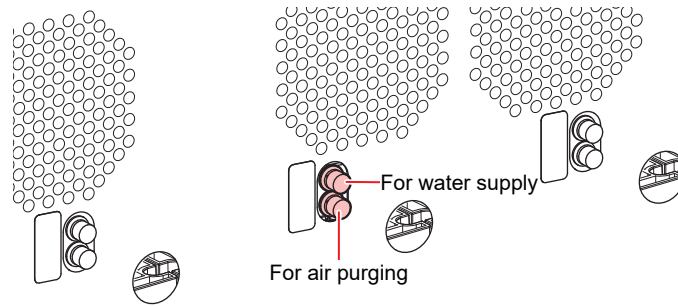

6 Inject the mixture of water and antifreeze.

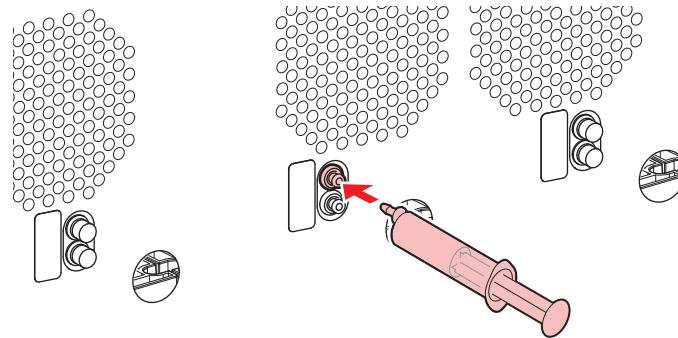

- The buzzer will stop after you inject about 400 ml of the mixture into each tank.

7 After the buzzer stops, inject an additional 430 ml of the mixture into each tank.



- Do not inject more than 430 ml of additional mixture. Injecting more may cause the tank to overflow.

8 After injection is finished, replace the caps.

Bottle Cap Replacement

Replace approximately once a year. For information on the replacement procedure, refer to  ["Replacing Ink"\(P. 45\)](#).



- Pay close attention to ventilation and be sure to wear safety glasses, gloves, and a mask when handling ink, maintenance liquid, waste ink, or other solutions used with the machine. Leaking ink may adhere to the skin or get into the eyes or mouth.



Chapter 5 Troubleshooting



This chapter

This chapter describes corrective actions for troubleshooting and messages on the display.

| | | | |
|--|-----|--|-----|
| Troubleshooting..... | 154 | The light-blocking cover comes off. | 159 |
| The power does not turn on. | 154 | Touch panel operation is not possible. | 160 |
| Printing is not possible. | 154 | Nozzle clogging occurs frequently when clear ink is used. | 160 |
| The media jams or the media is dirty. | 154 | Problems Causing Messages to Appear | 161 |
| Image defects occur..... | 154 | Collecting Logs..... | 174 |
| A pressure error occurred. | 158 | | |
| The ink has leaked..... | 159 | | |

5.1 Troubleshooting

For information on troubleshooting, refer to this chapter. Refer to the Mimaki website (<https://mimaki.com/support/>) for frequently asked questions (FAQs) about the machine and customer support videos.

If the recommended corrective action does not resolve the problem, contact your local dealer or our service office.

The power does not turn on.

| Points to check | Corrective action |
|--|---|
| <ul style="list-style-type: none"> For JFX600-2513 machine numbers 1 to 20 Is the power cable connected to the machine? | Insert the power socket until it clicks into place. |
| Is the main power supply turned on? | Turn on the main power supply. "Turning On the Power"(P. 125) |
| Is the PRINTER STATUS icon on the touch panel set to ? | Turn the power on. "Power Supply"(P. 124) |

Printing is not possible.





















| Points to check | Corrective action |
|---|--|
| Is the LAN cable connected to the machine also connected to the control PC? | Insert the LAN cable connector into the LAN port until it clicks into place. "System Configuration"(P. 35) |
| Does an "Ink end" message appear in SYSTEM ALARM on the touch panel? | Replace with new ink. "Ink Replacement Method"(P. 44) |
| Does a message appear in SYSTEM ALARM on the touch panel? | Take appropriate measures based on the message. "SYSTEM ALARM"(P. 108) "Problems Causing Messages to Appear"(P. 161) |

The media jams or the media is dirty.

| Points to check | Corrective action |
|--------------------------------------|--|
| Are you using the recommended media? | Make sure you are using the recommended media. https://mimaki.com/supply/inkjet.html |
| Are you using curled media? | Do not use curled media or media with folded ends. |
| Is media warped after being printed? | Changing UV illuminance may reduce the warp of printed media. "Setting Print Conditions"(P. 93) |

Image defects occur.

| Symptom / Points to check | Corrective action |
|---|--|
| White stripes, blurs, and dark stripes occur. (Scan (horizontal) direction) | <ol style="list-style-type: none"> Remove any paper scraps or other debris adhering to areas over which the print head passes. "Table Cleaning"(P. 137) Perform the procedure described in "Head Cleaning"(P. 78). |

| Symptom / Points to check | Corrective action |
|---|---|
| | <ol style="list-style-type: none"> 3. Perform the procedure described in  "Wiper Cleaning"(P. 130). 4. Perform the procedure described in  "Cap Rubber Cleaning"(P. 132). 5. Perform the procedure described in  "Carriage Underside Cleaning"(P. 134). |
| Offsetting occurs during bidirectional printing. | <ol style="list-style-type: none"> 1. Perform the procedure described in  "Correcting the Dot Position"(P. 80). |
| Ink droplets drip during printing. | <ol style="list-style-type: none"> 1. Perform the procedure described in  "Wiper Cleaning"(P. 130). 2. Perform the procedure described in  "Cap Rubber Cleaning"(P. 132). 3. Perform the procedure described in  "Carriage Underside Cleaning"(P. 134). 4. Perform the procedure described in  "Head Cleaning"(P. 78). 5. Set auto maintenance.  "Maintenance Menu"(P. 111) |
| Clear clogged nozzles. | <ol style="list-style-type: none"> 1. Perform the procedure described in  "Head Cleaning"(P. 78). 2. Perform the procedure described in  "Wiper Cleaning"(P. 130). 3. Perform the procedure described in  "Cap Rubber Cleaning"(P. 132). 4. Perform the procedure described in  "Ink fillup (Print head)"(P. 155). 5. Perform the procedure described in  "Wiper Replacement"(P. 145). 6. Set [MAINTENANCE] > [Nozzle recovery] > [Nozzle recovery] to "On". |
| Is the head gap excessive? | Reduce the head gap. If the head gap cannot be reduced, increase flushing frequency during printing ( "Maintenance Menu"(P. 111)) or make regular test prints to check for nozzle clogging. |
| Are there any ink colors that aren't used much? | Increase the refresh level ( "Setting 1 Menu"(P. 117)) during printing. Discharge from infrequently used nozzles tends to be inconsistent. Increasing the refresh level will allow more frequent nozzle use but increase ink consumption. |
| Are you using media easily affected by static electricity? | Increase flushing intervals during printing ( "Maintenance Menu"(P. 111)  "Setting 1 Menu"(P. 117)) or make regular test prints to check for nozzle clogging. Otherwise, use an optional ionizer. |
| Are you using mirrors, polished stainless steel plate, or gold or silver foil media? | When using reflective media, increase the flushing interval increase flushing frequency during printing ( "Setting 1 Menu"(P. 117)) or make regular test prints to check for nozzle clogging. |
| Are you using media with an uneven surface? | More light is reflected by uneven media than flat media. To reduce reflected light from sources other than the media, reduce unevenness as much as possible by loading unneeded media (thinner than the media used for printing) on the suction surface of the table even where no media is loaded. |
| Is the machine installed in a location with low humidity? | Increase the humidity by installing a humidifier or similar equipment. When printing continuously, increase flushing frequency during printing ( "Setting 1 Menu"(P. 117)) or make regular test prints to check for nozzle clogging. Otherwise, use an optional ionizer. |
| Is the machine installed in a location with significant amounts of airborne dust or powder? | Install the machine in a location free of excessive dust or powder (office equivalent: dust levels = 0.15 mg/m ³). If the printer is installed elsewhere, make regular test prints to confirm no nozzle clogging occurs. |

Ink fillup (Print head)

If ejection failures (e.g., nozzle clogging or deflection) remain unresolved even after head cleaning ( "Head Cleaning"(P. 78)), perform head filling.

- 1 From MENU on the touch panel, tap [MAINTENANCE].
 - The Maintenance menu is displayed.
- 2 Tap [Cleaning] > [Ink fillup (Print head)].
 - A dialog box appears.
- 3 Select the head for filling.

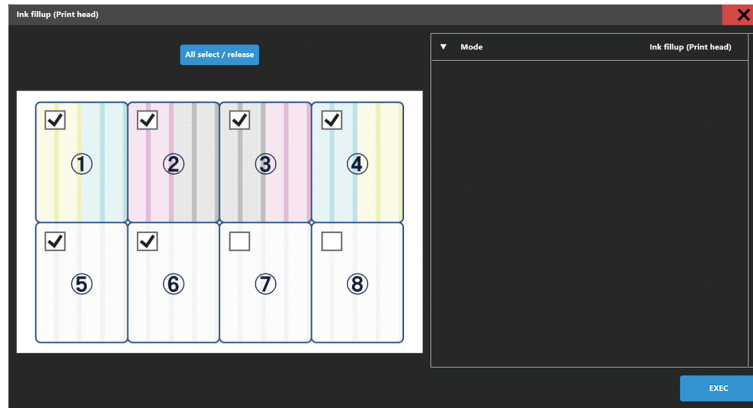

- 4 Tap [EXEC].
 - Filling begins. Head filling takes around ten minutes when eight paths are selected.



- If ejection failures (e.g., nozzle clogging, deflection) remain unresolved even after repeated head filling, contact your local dealer or our service office.

Cleaning the Print Head Nozzle Surface

Clean the print head nozzle surface if other cleaning or maintenance fails to resolve ejection failures (e.g., nozzle clogging, deflection).



- Allow only personnel trained by Mimaki engineers to clean the head nozzle surface. Allowing those without adequate training to clean nozzle surfaces may result in head failure.



- Use only the supplies specified by Mimaki. Cleaning with other products may cause print head wear.

- 1 From MENU on the touch panel, tap [MAINTENANCE].
 - The Maintenance menu is displayed.
- 2 Tap [Daily maintenance] > [Head maintenance].
 - The carriage moves to the maintenance space.

3 Slide the maintenance cover on the left side of the Y-bar.

- Lift the lever and slide it to the left.

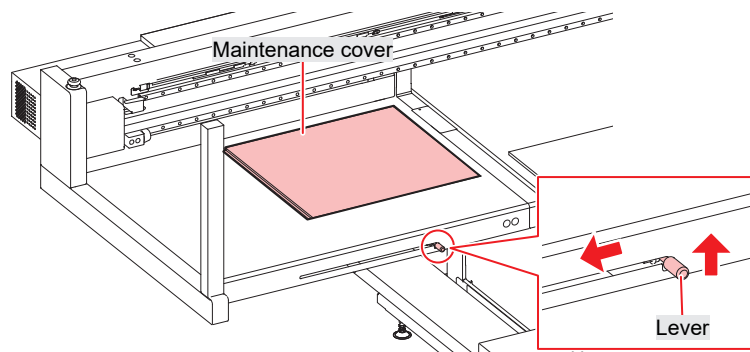

4 The nozzle surface is cleaned.

- Gently press a cleaning stick moistened with maintenance fluid against the nozzle surface for about 10 seconds.

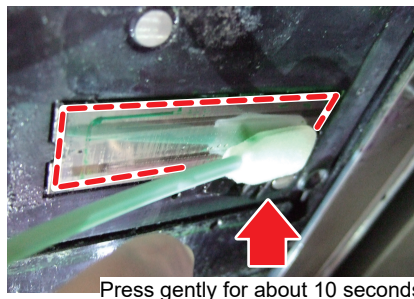

- Do not rub or press the cleaning stick with excessive force against the nozzle surface. Doing so may cause print head wear.
- Do not reuse cleaning sticks.

5 Once cleaning is complete, slide the maintenance cover on the left side of the Y-bar to close it.

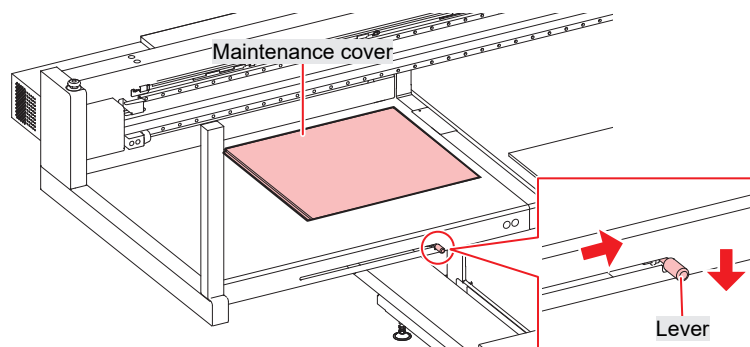

- Make sure the maintenance cover is returned to the correct position.

6 Tap [Complete] > [Finish].

7 Execute cleaning (in normal mode).

- "Head Cleaning"(P. 78)

8 Make a test print and check the print results.

- Repeat the cleaning and test printing process until the print results appear normal.

A pressure error occurred.

Depending on the usage environment and machine service life, the pressure controlled by the machine may exceed the range. If a pressure error occurs, adjust the pressure as soon as possible to restore normal conditions.

● For positive pressure adjustment

1 From MENU on the touch panel, tap [MAINTENANCE].

- The Maintenance menu is displayed.

2 Tap [Other maintenance].

3 Tap [Adjust positive pressure].

4 Release the pressure.

- Turn the positive pressure adjustment screw to the positions shown below.

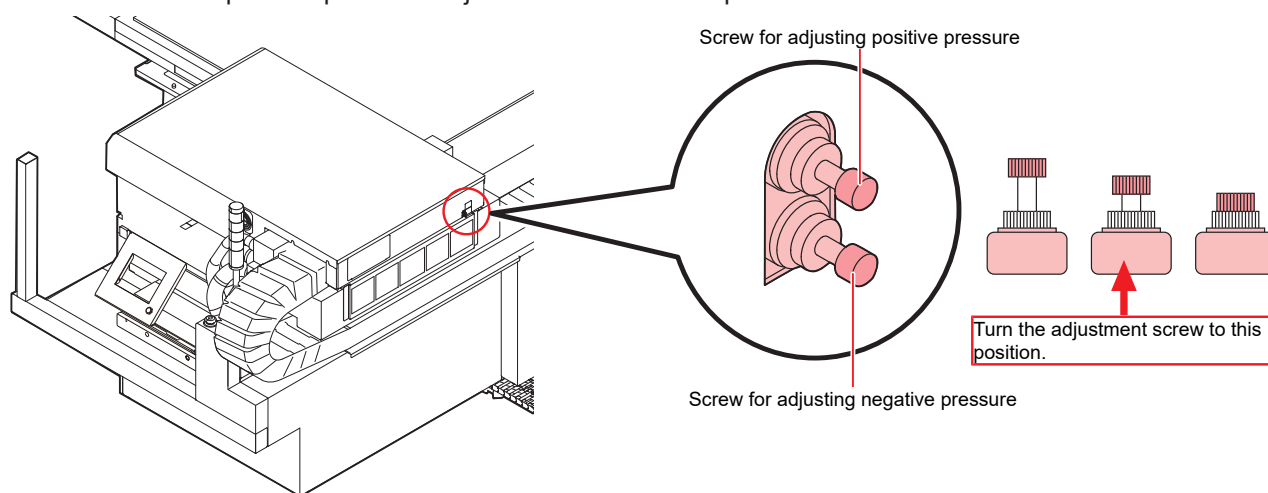

5 Turn the positive pressure adjustment screw to adjust pressure.

- Adjust while checking the color of the signal tower light. When the signal tower light is lit in green, stop turning the adjustment screw.



- Signal tower light illuminated in green: Correct value
- Signal tower light illuminated in red: Out of range Loosen the adjustment screw.
- Signal tower light illuminated in white: Out of range Tighten the adjustment screw.

6 Tap [Complete].

- The error is cleared. Negative pressure control begins.

● For negative pressure adjustment

1 From MENU on the touch panel, tap [MAINTENANCE].

- The Maintenance menu is displayed.

2 Tap [Other maintenance].

3 Tap [Adjust negative pressure].

4 Release the pressure.

- Turn the negative pressure adjustment screw to the positions shown below.

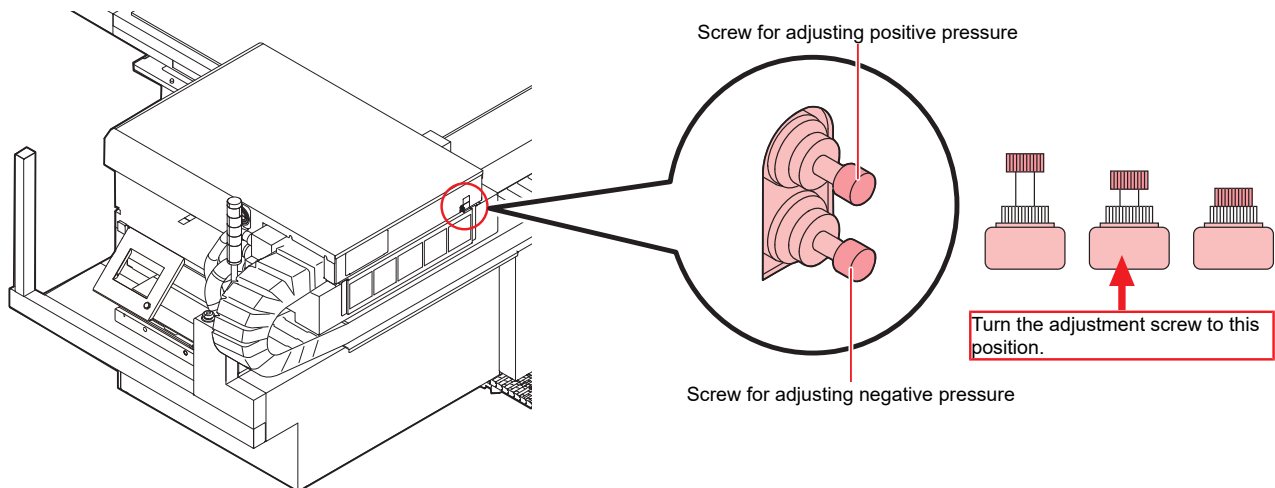

5 Turn the negative pressure adjustment screw to adjust pressure.

- Adjust while checking the color of the signal tower light. When the signal tower light is lit in green, stop turning the adjustment screw.



- Signal tower light illuminated in green: Correct value
- Signal tower light illuminated in red: Out of range Loosen the adjustment screw.
- Signal tower light illuminated in white: Out of range Tighten the adjustment screw.

6 Tap [Complete].

- The error is cleared. Negative pressure control begins.

The ink has leaked.



- If an ink leak occurs, turn off the three main power supply switches immediately. Then, contact your local dealer or our service office.

The light-blocking cover comes off.

If the light-blocking cover comes loose, the ink inside the tank may be exposed to light and begin to harden. If the light-blocking cover comes loose, reattach as follows:

1 Insert the lug on one side of the light-blocking cover into the corresponding hole in the tank.

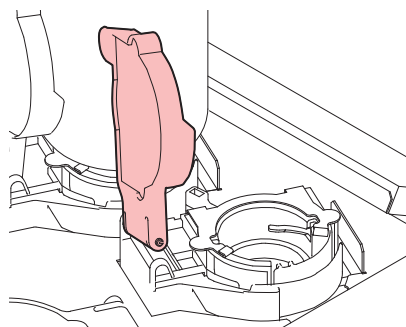

2 Insert the lug on the other side while pushing in toward the first hole in Step 1.

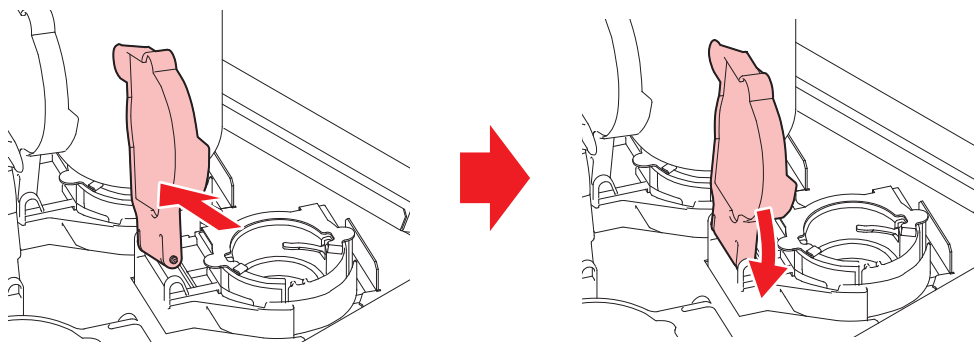

Touch panel operation is not possible.

| Points to check | Corrective action |
|--|--|
| Are any objects such as tape or labels affixed to the touch panel screen or the black outer frame? | Touch panel operation may not be possible if objects such as tape or labels are attached to it. Please remove any such objects before operation. |
| Is the touch panel dirty? | If it is very dirty, gently wipe off the dirt with a soft cloth. |

Nozzle clogging occurs frequently when clear ink is used.

If nozzle clogging occurs frequently when clear ink is used, replacing with the hard wiper kit can eliminate nozzle clogging.

For more information, contact your local dealer or our service office.



5.2 Problems Causing Messages to Appear



If a problem occurs, the buzzer will sound and a message will appear in SYSTEM ALARM on the touch panel. Take appropriate measures based on the message. If a message is displayed again even after you take the recommended corrective action, contact your local dealer or our service office.





| Error number | Message | Cause | Corrective action |
|--------------|------------------|--|--|
| 0104 | +35V RECVR | <ul style="list-style-type: none"> A problem was detected with the control PCB. | <ul style="list-style-type: none"> Turn off the control PC, and then turn off the main power supply of the machine. Wait briefly before turning the control PC and the main power supply back on. If this message reappears, contact your local dealer or our service office. |
| 010E | FROM CLEAR | | |
| 010F | FROM WRITE | | |
| 0115 | PCB MAIN-F1 | | |
| 0116 | PCB MAIN-F2 | | |
| 011F | PCB SLIDER | | |
| 0122 | CHECK :SDRAM | | |
| 0123 | PRAM DATA | | |
| 0124 | PRAM ADDR | | |
| 0127 | POWER OFF | | |
| 0128 | HDC FIFO | | |
| 0129 | BATTERY EXCHANGE | <ul style="list-style-type: none"> The machine has detected that the internal clock battery is nearly exhausted. | <ul style="list-style-type: none"> Contact your local dealer or our service office. |
| 012A | HDC SPEED | <ul style="list-style-type: none"> A problem was detected with the print head control. | |
| 012D | PCB MAIN-F4 | <ul style="list-style-type: none"> Blown main PCB fuse. | <ul style="list-style-type: none"> Turn off the control PC, then turn off the main power. Wait briefly before turning the control PC and the main power back on. |
| 012E | HeadFaild | <ul style="list-style-type: none"> A problem was detected with the head. | |
| 0147 | DS-IC BUSY | <ul style="list-style-type: none"> The read/write process of the ink IC coincided with the read/write process of an IC in another path. | <ul style="list-style-type: none"> Turn off the control PC, and then turn off the main power supply of the machine. Wait briefly before turning the control PC and the main power supply back on. If this message reappears, contact your local dealer or our service office. |
| 0151 | Main PCB V1R2 | <ul style="list-style-type: none"> A problem was detected with the main PCB power supply circuit. | |
| 0152 | Main PCB V2R5 | | |
| 0153 | Main PCB V3R3 | | |
| 0154 | Main PCB V05 | | |
| 0155 | Main PCB V36-1 | | |
| 0156 | Main PCB V5B | | |
| 0157 | Main PCB VTT | | |
| 0158 | Main PCB V36-2 | | |
| 0159 | PCB EXIO-FUSE | | |





| Error number | Message | Cause | Corrective action |
|--------------|-------------------|--|--|
| 016E | Main PCB V3R3B | <ul style="list-style-type: none"> A problem was detected with the main PCB power supply circuit. | <ul style="list-style-type: none"> Turn off the control PC, and then turn off the main power supply of the machine. Wait briefly before turning the control PC and the main power supply back on. If this message reappears, contact your local dealer or our service office. |
| 0171 | NEW HEAD CONNECT | <ul style="list-style-type: none"> New head connection detected. | |
| 0172 | Main PCB Q6 Check | <ul style="list-style-type: none"> A problem was detected with the main PCB power supply circuit. | |
| 017E | PCB IIO1 | <ul style="list-style-type: none"> The first ink-IO PCB could not be detected. | |
| 017F | PCB IIO2 | <ul style="list-style-type: none"> The second ink-IO PCB could not be detected. | |
| 0180 | PCB IIO3 | <ul style="list-style-type: none"> The third ink-IO PCB could not be detected. | |
| 0181 | PCB H21 | <ul style="list-style-type: none"> HDC PCB 1 could not be detected. | |
| 0182 | PCB H22 | <ul style="list-style-type: none"> HDC PCB 2 could not be detected. | |
| 0188 | HDC MEMORY | <ul style="list-style-type: none"> The waveform memory could not be written. | |
| 0189 | COM VOLT | <ul style="list-style-type: none"> A problem was detected with the COM voltage. | |
| 018A | Main PCB V_CORE | <ul style="list-style-type: none"> A problem was detected with the main PCB power supply circuit. | |
| 018B | Main PCB V1R5B | | |
| 018C | Main PCB V12 | | |
| 018D | PCB EXIO | <ul style="list-style-type: none"> A control PCB problem occurred. | |
| 018E | FLS NOT COMP | <ul style="list-style-type: none"> Ink ejection control error | |
| 018F | OFFSET WAVE | <ul style="list-style-type: none"> A problem was detected with the print head control. | |
| 0190 | Main PCB V_V1 | <ul style="list-style-type: none"> A problem was detected with the main PCB power supply circuit. | |
| 019D | HDC VOLT ERROR | <ul style="list-style-type: none"> A problem was detected with the PCB. | |
| 019E | HDC FUSE ERROR | <ul style="list-style-type: none"> Blown PCB fuse | |
| 019F | LED CONNCT ERR | <ul style="list-style-type: none"> The UV-LED PCB could not be detected. | |
| 01A2 | PCB DRV1 | <ul style="list-style-type: none"> DRV PCB 1 could not be detected. | |
| 01A3 | PCB DRV2 | <ul style="list-style-type: none"> DRV PCB 2 could not be detected. | |





| Error number | Message | Cause | Corrective action |
|--------------|-------------------|--|--|
| 01A4 | PCB DRV3 | <ul style="list-style-type: none"> • DRV PCB 3 could not be detected. | <ul style="list-style-type: none"> • Turn off the control PC, and then turn off the main power supply of the machine. Wait briefly before turning the control PC and the main power supply back on. If this message reappears, contact your local dealer or our service office. |
| 01AE | PCB CIO2 | <ul style="list-style-type: none"> • CIO PCB 2 could not be detected. | |
| 01BF | PCB MAIN-F2/F3 | <ul style="list-style-type: none"> • Blown main PCB fuse. | |
| 01C4 | HDC FUSE ERROR | <ul style="list-style-type: none"> • Blown PCB fuse | |
| 01C5 | PCB IIO-FUSE | <ul style="list-style-type: none"> • Blown PCB fuse | |
| 01D1 | PCB EXIO-FUSE | <ul style="list-style-type: none"> • Blown PCB fuse | |
| 01E7 | PCB INKCTRL1 | <ul style="list-style-type: none"> • A control PCB problem occurred. | |
| 01E8 | PCB INKCTRL2 | | |
| 01E9 | PCB INKCTR-FUSE | <ul style="list-style-type: none"> • Blown PCB fuse | |
| 01EB | PCB BIO | <ul style="list-style-type: none"> • A control PCB problem occurred. | |
| 0201 | COMMAND | <ul style="list-style-type: none"> • Communication error between the PC and the printer | |
| 0202 | PARAMETER | | |
| 0203 | Ment Command | | |
| 030C | SCAN DATA TIMEOUT | | |
| 0310 | PORT OPEN ERROR | <ul style="list-style-type: none"> • MAIN-PE FW communication error The Ethernet ports cannot be opened between PCBs. | |
| 0311 | ACK ERROR | <ul style="list-style-type: none"> • MAIN-PE FW communication error | |
| 0312 | CMD ERROR | <ul style="list-style-type: none"> • MAIN-PE FW communication error An error was detected for the command. | |
| 0313 | CMD TIMEOUT | <ul style="list-style-type: none"> • MAIN-PE FW communication error An error was detected for the command. | |
| 0314 | NOTICE ERROR | <ul style="list-style-type: none"> • MAIN-PE FW communication error Notifications cannot be received from PE-FW. | |
| 0401 | MOTOR X | <ul style="list-style-type: none"> • The X motor was overloaded. | <ul style="list-style-type: none"> • Turn off the control PC, and then turn off the main power supply of the machine. Wait briefly before turning the control PC and the main power supply back on. |
| 0402 | MOTOR Y | <ul style="list-style-type: none"> • The Y motor was overloaded. | |
| 0403 | X CURRENT | <ul style="list-style-type: none"> • An overcurrent was detected in the X motor. | |
| 0404 | Y CURRENT | <ul style="list-style-type: none"> • An overcurrent was detected in the Y motor. | |

| Error number | Message | Cause | Corrective action |
|--------------|-------------------------------------|---|--|
| 0405 | STATION ERROR | <ul style="list-style-type: none"> The station was close to exceeding its movement limit. | <ul style="list-style-type: none"> Turn off the control PC, and then turn off the main power supply of the machine. Wait briefly before turning the control PC and the main power supply back on. If this message reappears, contact your local dealer or our service office. |
| 0406 | Wiper origin detection failure | <ul style="list-style-type: none"> The wiper origin could not be detected. | |
| 0478 | OPTION BLOWER(FRONT) | <ul style="list-style-type: none"> Optional blower error | |
| 0479 | OPTION BLOWER(REAR) | <ul style="list-style-type: none"> Optional blower error | |
| 0505 | MEDIA JAM | <ul style="list-style-type: none"> The media jam sensor was triggered. | <ol style="list-style-type: none"> Remove the media in contact with the carriage and reload with fresh media. Clear the alarm on the touch panel.  "Clearing Alarms"(P. 109) |
| 0506 | Station sensor | <ul style="list-style-type: none"> The station sensor could not be detected. | <ul style="list-style-type: none"> Turn off the control PC, and then turn off the main power supply of the machine. Wait briefly before turning the control PC and the main power supply back on. If this message reappears, contact your local dealer or our service office. |
| 0509 | HDC Position count | <ul style="list-style-type: none"> A problem was detected with position control. | |
| 050A | Y origin detection failure | <ul style="list-style-type: none"> A problem was detected with the Y origin detection sensor. | |
| 0533 | X origin detection failure | <ul style="list-style-type: none"> A problem was detected with the X origin detection sensor. | |
| 0511 | Z origin detection failure | <ul style="list-style-type: none"> A problem was detected with the Z origin detection sensor. | |
| 0512 | Capshutter origin detection failure | <ul style="list-style-type: none"> A problem was detected with the shutter sensor. | |
| 0515 | Thickness measurement failure | <ul style="list-style-type: none"> A problem was detected with the gap pin detection sensor. | |
| 0519 | NEGATIVE PRESS SENSOR | <ul style="list-style-type: none"> Negative pressure sensor problem detected | |
| 051A | POSITIVE PRESS SENSOR | <ul style="list-style-type: none"> Positive pressure sensor problem detected. | <ul style="list-style-type: none"> Adjust the pressure.  "A pressure error occurred."(P. 158) |
| 051E | PL ENC SNS | <ul style="list-style-type: none"> Reduced sensitivity of the X linear scale | <ul style="list-style-type: none"> Turn off the control PC, and then turn off the main power supply of the machine. Wait briefly before turning the control PC and the main power supply back on. If this message reappears, contact your local dealer or our service office. |
| 0525 | WRONG IONIZER | <ul style="list-style-type: none"> The ionizer internal circuit is defective, or an abnormal discharge occurred. | |
| 0526 | IONIZER ION LEVEL | <ul style="list-style-type: none"> The amount of generated ions was reduced due to fouling and abrasion of the electrode needle. | <ul style="list-style-type: none"> Refer to the operation manual for the ionizer and clean the electrode probes. If this error continues to be displayed after cleaning, contact your local dealer or our service office. |

| Error number | Message | Cause | Corrective action |
|--------------|---------------------------------|---|---|
| 0527 | IONIZER CONDITION | <ul style="list-style-type: none"> Ambient conditions may cause ions to be absorbed by metals in the vicinity and affect discharge capability. | <ul style="list-style-type: none"> Please check for any metallic objects in the vicinity of the ionizer. Be sure to remove any metallic objects that are found. If this error continues to be displayed after removing such objects, contact your local dealer or our service office. |
| 0531 | WRONG SUBTANK SENSOR | <ul style="list-style-type: none"> A problem occurred with the ink supply unit's scales. | <ul style="list-style-type: none"> Check if the ink tank is correctly installed, if it has not been subjected to impact, or if anything heavy is not placed on top of it. Turn off the control PC, and then turn off the main power supply of the machine. Wait briefly before turning the control PC and the main power supply back on. If the problem persists, contact your dealer or our service office. |
| 0539 | WRONG CALIBRATION VALUE | <ul style="list-style-type: none"> Tank calibration is incomplete. | <ul style="list-style-type: none"> For the tank experiencing the error, execute [MAINTENANCE] > [Ink supply option] > [Tank calibration] on the touch panel. Clear the alarm on the touch panel.  "Clearing Alarms"(P. 109) If the problem persists, contact your dealer or our service office. |
| 0542 | Emergency switch | <ul style="list-style-type: none"> The emergency stop switch was pressed. | <ol style="list-style-type: none"> Resolve the cause of this problem. Turn the emergency stop switch to unlock. Clear the alarm on the touch panel.  "Clearing Alarms"(P. 109) <ul style="list-style-type: none"> Clearing the alarm will start the initial operations. |
| 054A | PDC Position interrupt | <ul style="list-style-type: none"> There is a problem with the scan control coordinates. | <ul style="list-style-type: none"> Turn off the control PC, and then turn off the main power supply of the machine. Wait briefly before turning the control PC and the main power supply back on. If this message reappears, contact your local dealer or our service office. |
| 0551 | HDC DIO LENC count | <ul style="list-style-type: none"> A problem was detected with the HDC and DIO PCB encoder values. | <ul style="list-style-type: none"> Turn off the control PC, then turn off the main power supply of the machine. Wait briefly before turning the control PC and the main power supply back on. If this message reappears, contact your dealer or our service office. |
| 0556 | Y LIMIT SENSOR | <ul style="list-style-type: none"> The carriage has exceeded the operating range in the Y direction. | <ul style="list-style-type: none"> Contact your local dealer or our service office. |
| 0557 | Light curtain detects obstacles | <ul style="list-style-type: none"> The light curtain was triggered. | <ol style="list-style-type: none"> Remove the obstacle from the light curtain detection area.  "Light Curtain"(P. 34) |

| Error number | Message | Cause | Corrective action |
|--------------|--------------------------|--|--|
| | | | 2. Clear the alarm on the touch panel.  "Clearing Alarms"(P. 109) |
| 0558 | PDC Scan position | <ul style="list-style-type: none"> • A problem occurred with the Y motor control coordinates. • A problem occurred with the Y motor. | <ul style="list-style-type: none"> • Turn off the control PC, then turn off the main power supply of the machine. Wait briefly before turning the control PC and the main power supply back on. If this message reappears, contact your dealer or our service office. |
| 0561 | Carriage Cap Sensor | <ul style="list-style-type: none"> • There is a problem with the carriage CAP sensor. | <ul style="list-style-type: none"> • Contact your local dealer or our service office. |
| 0601 | INK NEAR END | <ul style="list-style-type: none"> • The ink tank is running low on ink. | Ink is running low. Replace the ink bottle as follows: |
| 0602 | INK END | <ul style="list-style-type: none"> • The ink tank has run out of ink. | <ol style="list-style-type: none"> 1. Pull out the old ink IC. 2. Remove the old ink bottle. 3. Transfer the bottle cap from the old bottle to a new one. Then, insert the new bottle. 4. Insert a new ink IC. <p>If the problem persists, the sealing film on the bottle might not have been removed, preventing ink from transferring to the MBIS tank. Remove the ink bottle and verify that the film has been removed.</p> |
| 0603 | NO INK TANK | <ul style="list-style-type: none"> • The ink tank is not being detected. | <ul style="list-style-type: none"> • Remove and then reinstall the ink tank, and then execute [CLEAR ALARM]. For details, refer to "Clearing Alarms." <p>If this message reappears, execute [MAINTENANCE] > [Ink supply option] > [Tank calibration] on the touch panel. Afterwards, execute [CLEAR ALARM]. If the problem persists, contact your dealer or our service office.</p> |
| 0604 | WASTE INK TANK NEAR FULL | <ul style="list-style-type: none"> • The waste ink tank is nearly full. | <ul style="list-style-type: none"> • Note that the waste ink tank will be full soon. |
| 0605 | REPLACE WIPER | <ul style="list-style-type: none"> • It is time to replace the wiper. | <ol style="list-style-type: none"> 1. Replace the wiper.  "Wiper Replacement"(P. 145) 2. Clear the alarm on the touch panel.  "Clearing Alarms"(P. 109) |
| 0606 | WRONG INK IC | <ul style="list-style-type: none"> • The ink IC chip cannot be read correctly. | <ol style="list-style-type: none"> 1. Reinsert the ink IC chip. 2. Clear the alarm on the touch panel.  "Clearing Alarms"(P. 109) 3. If this error continues to be displayed after restarting, insert the supplied ink IC into the new ink bottle. |
| 060C | INK TYPE | <ul style="list-style-type: none"> • An ink IC of a different ink type was detected. | <ul style="list-style-type: none"> • Reinsert the ink IC. Afterwards, execute [CLEAR ALARM]. For details, refer to "Clearing Alarms." <p>If this message reappears, contact your dealer or our service office.</p> |



| Error number | Message | Cause | Corrective action |
|--------------|---------------------------|---|--|
| 060F | INK EXPIRATION | <ul style="list-style-type: none"> The ink has expired. | <ul style="list-style-type: none"> Replace with new ink or use up as quickly as possible. Printing is possible.  "Replacing Ink"(P. 45) If this message is displayed when inserting an ink IC chip into an ink bottle that has not reached its expiration date, contact your local dealer or our service office. |
| 0610 | NOT FILLUP | <ul style="list-style-type: none"> Ink filling is not complete. | <ul style="list-style-type: none"> Contact your local dealer or our service office. |
| 0617 | WRONG SUBTANK SENSOR | <ul style="list-style-type: none"> A sub-tank fluid level sensor error was detected. | <ul style="list-style-type: none"> Turn off the control PC, and then turn off the main power supply of the machine. Wait briefly before turning the control PC and the main power supply back on. If this message reappears, contact your local dealer or our service office. |
| 061A | INK OVERFLOW | <ul style="list-style-type: none"> Sub-tank sensor limit detected | <ol style="list-style-type: none"> Execute [MAINTENANCE] > [Other maintenance] > [Sub-tank maintenance]. Clear the alarm on the touch panel.  "Clearing Alarms"(P. 109) |
| 061B | INK SUPPLY | <ul style="list-style-type: none"> Ink cannot be supplied to the sub-tank. | <ol style="list-style-type: none"> Execute [MAINTENANCE] > [Other maintenance] > [Sub-tank maintenance]. Clear the alarm on the touch panel.  "Clearing Alarms"(P. 109) If this error continues to be displayed after clearing, turn off the control PC, then turn off the main power. Wait briefly before turning the control PC and the main power back on. Execute [MAINTENANCE] > [Other maintenance] > [Sub-tank maintenance]. |
| 061C | NEGATIVE PRESS CONTROL | <ul style="list-style-type: none"> Negative pressure control could not be initiated. | <ol style="list-style-type: none"> If the error message starts with "NEGATIVE...", execute [MAINTENANCE] > [Other maintenance] > [Adjust negative pressure]. If it starts with "POSITIVE...", execute [MAINTENANCE] > [Other maintenance] > [Adjust positive pressure]. This will adjust the throttle valve opening degree. A pressure error occurred. After the function has finished, reapply the pressure. If this message reappears, contact your dealer or our service office. Execute [MAINTENANCE] > [Other maintenance] > [Adjust negative pressure]. |
| 061D | NEGATIVE PRESS NOT ENOUGH | <ul style="list-style-type: none"> Proper negative pressure cannot be maintained. | |
| 061E | NEGATIVE PRESS OVER | <ul style="list-style-type: none"> Excessive negative pressure | |
| 061F | POSITIVE PRESS CONTROL | <ul style="list-style-type: none"> Positive pressure control could not be initiated. | |
| 0620 | POSITIVE PRESS NOT ENOUGH | <ul style="list-style-type: none"> Proper positive pressure cannot be maintained. | |
| 0621 | POSITIVE PRESS OVER | <ul style="list-style-type: none"> Excessive positive pressure | |
| 0629 | INK EXPIRATION 1MONTH | <ul style="list-style-type: none"> The ink is one month past its expiration date and cannot be used. | <ol style="list-style-type: none"> Replace with new ink or use up as quickly as possible. Replace the ink IC chip, then clear the alarm on the touch panel.  "Clearing Alarms"(P. 109) |

| Error number | Message | Cause | Corrective action |
|--------------|------------------------|--|--|
| 062A | INK EXPIRATION 2MONTH | <ul style="list-style-type: none"> The ink is two months past its expiration date and cannot be used. | <ol style="list-style-type: none"> Replace with new ink. Replace the ink IC chip, then clear the alarm on the touch panel.  "Clearing Alarms"(P. 109) |
| 0631 | INK COLOR | <ul style="list-style-type: none"> The ink color registered on the ink IC chip differs from the ink color filled. | <ol style="list-style-type: none"> Insert the ink IC chip supplied with the correct color ink bottle. Clear the alarm on the touch panel.  "Clearing Alarms"(P. 109) |
| 0637 | INK LEAK | <ul style="list-style-type: none"> Ink is leaking from around the ink tank. | <ul style="list-style-type: none"> Contact your local dealer or our service office. |
| 063D | SUPPLY INK NEAR END | <ul style="list-style-type: none"> Ink cannot be supplied due to an ink supply unit or ink IC chip error. | <ol style="list-style-type: none"> Check the ink bottle to see if there is any residual ink. Check to see if an ink IC chip error occurred. |
| 063E | SUPPLY INK END | <ul style="list-style-type: none"> Ink cannot be supplied due to an ink supply unit or ink IC chip error. Sub-tank was empty. | <ol style="list-style-type: none"> Clear the alarm on the touch panel.  "Clearing Alarms"(P. 109) |
| 0641 | CHARGED INK EXPIRATION | <ul style="list-style-type: none"> The charged ink has reached its expiration date. | <ul style="list-style-type: none"> The charged ink has reached its expiration date. Please use it up as soon as possible. |
| 0642 | INK EXPIRATION 1MONTH | <ul style="list-style-type: none"> The charged ink is one month past its expiration date. | <ul style="list-style-type: none"> The ink will soon become unusable. Please use it up as soon as possible. |
| 0643 | INK EXPIRATION 2MONTH | <ul style="list-style-type: none"> The charged ink is two months past its expiration date. | <ul style="list-style-type: none"> The ink is no longer usable. Execute [MAINTENANCE] > [Ink supply option] > [Dispose expired ink] to remove the ink from the tank. Afterwards, charge the tank with new ink. (Refer to "OPT-J0534 3L Ink Supply Unit Operation Manual.") |
| 0644 | SUPPLY INK NEAR END | <ul style="list-style-type: none"> The charge ink level is running low. | Charge the ink IC as follows: |
| 0645 | SUPPLY INK END | <ul style="list-style-type: none"> There is no charge ink remaining. | <ol style="list-style-type: none"> Insert a new ink IC. While charging the ink IC, check the ink level LED to ensure the charging is successfully completed. Refill the ink tank with ink. Execute [CLEAR ALARM] on the touch panel.  "Clearing Alarms"(P. 109) |
| 0646 | INK IC ALREADY USED | <ul style="list-style-type: none"> The machine detected that the ink IC from previously used ink was inserted. | <ul style="list-style-type: none"> Insert the ink IC supplied with the new ink bottle. |
| 064C | NCU ERROR | <ul style="list-style-type: none"> A problem was detected with the nozzle clogging assessment. | <ul style="list-style-type: none"> The NCU must be replaced. Contact your local dealer or our service office. |
| 064D | NCU Y ADJUST ERROR | <ul style="list-style-type: none"> NCU Y adjustment failed. | <ul style="list-style-type: none"> Clean the NCU.  "NCU Cleaning"(P. 133) |
| 064E | NCU S/N ADJUST ERROR | <ul style="list-style-type: none"> NCU S/N adjustment failed. | |

| Error number | Message | Cause | Corrective action |
|--------------|------------------------------|--|--|
| 0650 | NCU CONNECT | <ul style="list-style-type: none"> A problem was detected with the NCU connection. | <ul style="list-style-type: none"> Turn off the main power and wait briefly before turning the power back on. |
| 0651 | NCU SENSOR | <ul style="list-style-type: none"> A problem was detected with the nozzle clogging assessment. | <ul style="list-style-type: none"> The NCU must be replaced. Contact your local dealer or our service office. Clean the NCU. "NCU Cleaning"(P. 133) |
| 0652 | NCU Detection failure (HW) | | |
| 0653 | NCU Detection failure (MARK) | | |
| 0654 | NCU Center position | | |
| 0655 | NCU Flush position | <ul style="list-style-type: none"> Ink ejection position adjustment failed. | |
| 0656 | NCU Sensor adjust | <ul style="list-style-type: none"> Sensor sensitivity adjustment failed. | |
| 0657 | Check NCU waste ink. | <ul style="list-style-type: none"> It is time to replace the ink pad. | <ul style="list-style-type: none"> Replace the NCU ink pad. "NCU Ink Pad Replacement"(P. 147) |
| 0658 | NCU SENSOR LEVEL LOW | <ul style="list-style-type: none"> There is a drop in the sensor sensitivity level. | <ul style="list-style-type: none"> Clean the NCU. "NCU Cleaning"(P. 133) Replace the NCU if the error does not clear. Contact your local dealer or our service office. |
| 065B | NCU Sensitivity adjust Hi | <ul style="list-style-type: none"> Sensor sensitivity adjustment failed. | |
| 065C | NCU Sensitivity adjust Low | | |
| 0666 | WASTE INK TANK FULL | <ul style="list-style-type: none"> The waste ink tank is FULL. | <ol style="list-style-type: none"> Execute [Maintenance] > [Other maintenance] > [Replace waste ink tank]. Clear the alarm on the touch panel. "Clearing Alarms"(P. 109) |
| 0693 | Stirring stopped | <ul style="list-style-type: none"> The ink in one of the bottles in the 3L external supply unit cannot be stirred because the ink level in that bottle is 700 cc or less. | <ul style="list-style-type: none"> Refill the bottle with white ink. |
| 0705 | WATER LACK | <ul style="list-style-type: none"> The machine detected inadequate cooling water levels. | <ul style="list-style-type: none"> Refill the cooling water. "Refilling Cooling Water (Mixed With Antifreeze)"(P. 150) |
| 0706 | UV LAMP TEMP. HIGH | <ul style="list-style-type: none"> High UVLED PCB temperature detected. | <ul style="list-style-type: none"> Make sure the cooling unit tank is filled with cooling water. Turn off the control PC, then turn off the main power. Wait briefly before turning the control PC and the main power back on. |
| 0707 | Head heater break | <ul style="list-style-type: none"> The head heater is disconnected. | <ul style="list-style-type: none"> Turn off the control PC, and then turn off the main power supply of the machine. Wait briefly before turning the control PC and the main power supply back on. If this message reappears, contact your local dealer or our service office. |
| 070B | UV Drive PCB overheat | <ul style="list-style-type: none"> The UVDRV PCB was overheated. | |

| Error number | Message | Cause | Corrective action |
|--------------|---------------------|---|--|
| 0711 | UV Led PCB overheat | <ul style="list-style-type: none"> High UVLED PCB temperature detected. | <ul style="list-style-type: none"> Make sure the cooling unit tank is filled with cooling water. Turn off the control PC, then turn off the main power. Wait briefly before turning the control PC and the main power back on. |
| 0714 | INK HEATER COM ERR | <ul style="list-style-type: none"> Communication problem detected with ink heater PCB | <ul style="list-style-type: none"> Turn off the control PC, and then turn off the main power supply of the machine. Wait briefly before turning the control PC and the main power supply back on. If this message reappears, contact your local dealer or our service office. |
| 0715 | InkHeater Thr | <ul style="list-style-type: none"> Problem detected with ink heater thermistor | |
| 0716 | InkHeater Tmp | <ul style="list-style-type: none"> A problem was detected with the ink heater temperature. | |
| 0717 | Ink heater break | <ul style="list-style-type: none"> The ink heater is disconnected. | |
| 0718 | InkHeaterPCB Thr | <ul style="list-style-type: none"> Problem detected with ink heater PCB thermistor | |
| 0719 | InkHeaterPCB Fuse | <ul style="list-style-type: none"> Blown ink heater PCB fuse | |
| 071A | UV-DRV Fuse | <ul style="list-style-type: none"> A blown fuse was detected on the UV drive PCB. | |
| 0801 | (C) OPCODE | <ul style="list-style-type: none"> A problem was detected with the control PCB. | |
| 0802 | (C) SWI | | |
| 0803 | (C) PFTCH ABRT | | |
| 0804 | (C) DATA ABRT | | |
| 0806 | FW/SIO bit | | |
| 0807 | FW/SIO wbsy | | |
| 080E | FW/FROM prm | | |
| 080F | FW/SIO vch | | |
| 0811 | FW/SIO read | | |
| 0815 | FW/SIO rsrc | | |
| 0816 | FW/FROM WRC | | |
| 0817 | FW/SaveArea | | |
| 081B | FW/STACK OV | | |
| 0826 | FW/PrmSaveBuf | | |
| 0828 | PRG ERR L***** | | |
| 0829 | FW/ERASE TIMEOV | | |
| 083A | PARAMETER ERROR | <ul style="list-style-type: none"> A parameter error was detected. | |
| 083B | MESSAGE ERROR | <ul style="list-style-type: none"> A message between tasks contained an invalid value. | |

| Error number | Message | Cause | Corrective action |
|--------------|--------------------|---|---|
| 083C | INITIAL FAILD | <ul style="list-style-type: none"> Initialization failed. | <ul style="list-style-type: none"> Clear the alarm. Turn off the control PC, and then turn off the main power supply of the machine. Wait briefly before turning the control PC and the main power supply back on. |
| 0912 | INVALID INK CHARGE | <ul style="list-style-type: none"> The machine detected that an ink IC that cannot be used for ink charging was inserted. | <p>Check if the ink IC is inserted into the correct slot.</p> <p>Depending on the type of problem, take one of the following steps:</p> <ol style="list-style-type: none"> If charging failed because the ink has reached or is one month past its expiration date, execute [MAINTENANCE] > [Ink supply option] > [Ink charge] to perform ink charging. (If you proceed with ink charging, please use up the ink as soon as possible, as it will soon become unusable.) If charging failed due to incorrect ink type or color, insert the correct ink IC. If charging failed because the ink is two months past its expiration date, the ink IC is from previously used ink, or there is an IC error, insert a new ink IC. |
| 0913 | FULL CHARGE INK | <ul style="list-style-type: none"> No further charging is possible because the charge ink level is full. | <ul style="list-style-type: none"> Use up the ink and then reinsert the ink IC. |
| 0916 | ROM MISMATCH | <ul style="list-style-type: none"> Inappropriate ROM | <ul style="list-style-type: none"> Ensure the ROM matches the model being used. If this problem persists with the matching ROM, contact your local dealer or our service office. |
| 091D | COVER OPEN | <ul style="list-style-type: none"> The maintenance cover is open. | <ol style="list-style-type: none"> Close the maintenance cover. Clear the alarm on the touch panel.  "Clearing Alarms"(P. 109) |
| 0B0F | UVD PCB UV power | <ul style="list-style-type: none"> There is a problem with the UV drive 32B PCB LED POW (+36 V or +42 V) <ul style="list-style-type: none"> - JFX600-2513: 36 V - JFX600-2531: 42 V | <ul style="list-style-type: none"> Turn off the control PC, and then turn off the main power supply of the machine. Wait briefly before turning the control PC and the main power supply back on. If this message reappears, contact your local dealer or our service office. |
| 0B17 | PCB SLDT3 | <ul style="list-style-type: none"> The slider T PCB could not be detected. | |
| 0B25 | HDC DIRECTION | <ul style="list-style-type: none"> Scan control error | |
| 0B27 | HD LOGIC FUSE | <ul style="list-style-type: none"> Problem detected with print head control PCB | <ul style="list-style-type: none"> Turn off the control PC, then turn off the main power. Wait briefly before turning the control PC and the main power back on. |
| 0B28 | HD DRIVER FUSE | | |
| 0B29 | HD VLT ERR | | |
| 0B35 | HD VLT ERR | <ul style="list-style-type: none"> HD driver voltage 26 V error detected | |
| 0B38 | HD DRV V26 | <ul style="list-style-type: none"> HD driver voltage 26 V \pm5 % error | |

| Error number | Message | Cause | Corrective action |
|--------------|-------------------------------|--|--|
| 0B3E | PCB LOADCELL AD | <ul style="list-style-type: none"> A problem was detected with the load cell AD PCB. | |
| 0B54 | PCB INKIO-FUSE | <ul style="list-style-type: none"> Blown PCB fuse | <ul style="list-style-type: none"> Turn off the control PC, and then turn off the main power supply of the machine. Wait briefly before turning the control PC and the main power supply back on. If this message reappears, contact your local dealer or our service office. |
| 0D09 | HD MEMORY | <ul style="list-style-type: none"> Head memory access error | |
| 0D0B | HD CONNECT | <ul style="list-style-type: none"> A problem was detected with the head connector conversion PCB connection. | <ul style="list-style-type: none"> Turn off the control PC, then turn off the main power. Wait briefly before turning the control PC and the main power back on. |
| 0D0C | HD THERMIS | <ul style="list-style-type: none"> Problem detected with head temperature. | |
| 0D0D | HDC SPEED | <ul style="list-style-type: none"> Head control error | <ul style="list-style-type: none"> Turn off the control PC, and then turn off the main power supply of the machine. Wait briefly before turning the control PC and the main power supply back on. If this message reappears, contact your local dealer or our service office. |
| 0D1C | HD BUSY | <ul style="list-style-type: none"> An error was detected with the print head communication. | <ul style="list-style-type: none"> Turn off the control PC, then turn off the main power. Wait briefly before turning the control PC and the main power back on. |
| 0D1D | HD CMD | | |
| 0D1E | HD DRIVE HOT | <ul style="list-style-type: none"> High print head temperature was detected. | |
| 0108 | HD TYPE | <ul style="list-style-type: none"> A problem was detected with head control | |
| 0186 | HDC WAVEFLOW | <ul style="list-style-type: none"> A problem was detected with head control | |
| B001 | Shake the white ink bottle. | <ul style="list-style-type: none"> This is displayed when filled with white ink. (Each week) | <ul style="list-style-type: none"> Shake the white ink bottle.  "Ink Maintenance"(P. 130) |
| B002 | Replace the flushing filter. | <ul style="list-style-type: none"> This reminds you to replace the flushing filter every 30 days. | <ul style="list-style-type: none"> Replace the filter.  "Flushing Filter Replacement"(P. 147) |
| B003 | Replace the ink tank. | <ul style="list-style-type: none"> This reminds you to replace the ink tank at specified intervals (in days). | <ul style="list-style-type: none"> Replace the ink tank.  "Ink Replacement Method"(P. 44) |
| C111 | Print data transmission error | <ul style="list-style-type: none"> A communication error was detected between the control PC and firmware. | <ul style="list-style-type: none"> Turn off the control PC, then turn off the main power. After confirming that the LAN cable on the rear of the control PC is properly connected, turn the power back on. |

| Error number | Message | Cause | Corrective action |
|--------------|---------------------------------|--|---|
| C801 | Destination specification error | <ul style="list-style-type: none"> The initial operations of units comprising the machine failed. | <ul style="list-style-type: none"> Turn off the control PC, then turn off the main power. Wait briefly before turning the control PC and the main power back on. There are improper device configuration settings. Contact your local dealer or our service office. |
| C802 | Device composition ERROR | | |
| C803 | Version mismatch | <ul style="list-style-type: none"> Problem detected with version of units in the system | <ul style="list-style-type: none"> The version of units in the system is incorrect. Contact your local dealer or our service office. |

5.3 Collecting Logs

If a problem arises with the machine, you may be requested by our service engineers or service office to collect the corresponding logs. Please follow the procedure below to collect the logs if requested.

● Log collection tool

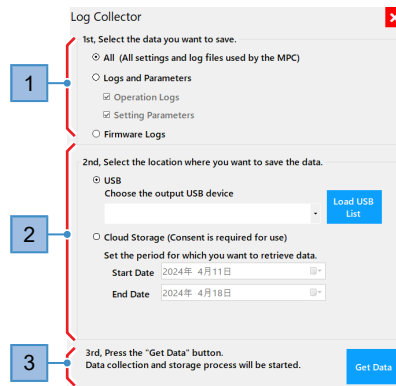

| No. | Overview |
|-----|---|
| 1 | <p>Select the data to be collected.</p> <ul style="list-style-type: none"> • All: Collects all log data. "All" should normally be selected. • Logs and Parameters: Allows either "Operation Logs" or "Setting Parameters" to be selected. • Firmware Log: Collects the firmware log. |
| 2 | <p>Select a destination for saving data to.</p> <ul style="list-style-type: none"> • USB: Saves to an external hard drive. <ul style="list-style-type: none"> – Choose the output USB device: Select the external hard drive to be saved to. – Load USB list: Tap if a particular external hard drive is not listed. • Cloud Storage: Saves log data directly to Mimaki cloud storage. <ul style="list-style-type: none"> – Set the period for which you want to retrieve data: Up to 180 days of log data can be set. |
| 3 | <p>Tap [Get Data] to start log data acquisition.</p> |

● Saving Log Data to an External Hard Drive

Save the logs to an external hard drive, and send the data to our service engineers by e-mail or other means.



- Please contact our service engineers if the log data volume is excessive.

- 1 Connect an external hard drive to the machine (control PC).**
- 2 From MENU on the touch panel, tap [SYSTEM] > [Log collection] > [Manual Log collection tool].**
 - The log collection tool starts up.  ["Log collection tool"\(P. 174\)](#)
- 3 Select the data to be collected.**
 - "All" should normally be selected.
- 4 Select a destination for saving data to.**
 - Select [USB], then select the external hard drive to be saved to.
- 5 Tap [Get Data].**
 - Data is saved in Zip format to the external hard drive.
Example: 20211001-0903_JFX600_A1234567_P.zip
20211001-0903_JFX600_A1234567_FWLOG.zip



- The log data has been encrypted and can be sent as is.

● Uploading the Logs to Cloud Storage

If the machine is connected to the Internet, you can save the logs directly to our cloud storage platform.



- Contact your network administrator for more information regarding network connectivity.
- Please be careful of the size of the log data if you are using a metered Internet connection.

- 1 From MENU on the touch panel, tap [SYSTEM] > [Log collection] > [Manual Log collection tool].**
 - The log collection tool starts up.  [P. 174](#)
- 2 Select the data to be collected.**
 - "All" should normally be selected.
- 3 Select a destination for saving data to.**
 - Select [Cloud Storage].
- 4 Set the log data collection interval.**
 - Set the time period specified by our service engineer.

5 Tap [Get Data].

- The log data is uploaded to the cloud storage platform.
- If it is the first time using this service, the [Cloud Settings] and [ConsentFormDialog] dialog boxes will appear.

● [Cloud Settings] dialog box

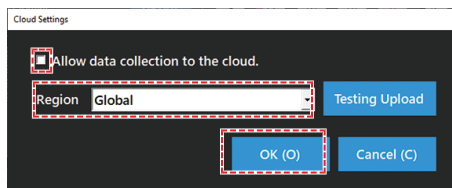

(1) Select the following check box:

- Allow data collection to the cloud

(2) Set [Region] to Global and tap [OK].

● [ConsentFormDialog] dialog box

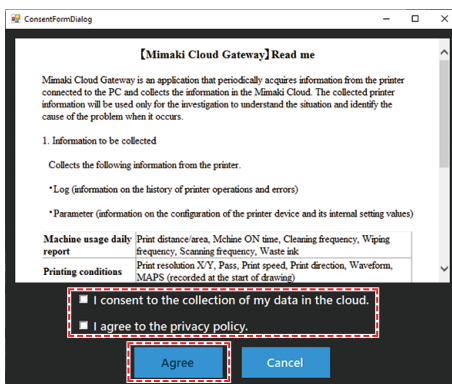

(1) Check the details described, then select the following check boxes:

- I consent to the collection of my data in the cloud
- I agree to the privacy policy

(2) Tap [Agree].

6 Please notify our service engineer once the upload is complete.

Chapter 6 Appendix



This chapter

This chapter describes the machine specifications.

6.1 Specifications

| Item | | JFX600-2531 |
|---|---------------------------------|---|
| Print head | Type | On-demand piezo head |
| | Specifications | 16 heads (4 staggered, 4 in-line array) |
| | Resolution | Y: 600 dpi, 1,200 dpi X: 600 dpi, 1,200 dpi |
| Ink set | 4-color | C, M, Y, K |
| | 4-color, 2W, CI, Pr | C, M, Y, K, 2W, CI, Pr |
| | 4-color, 2W, 2CI | C, M, Y, K, 2W, 2CI |
| | 6-color, 2W | C, M, Y, K, Lm, Lc, 2W |
| | 6-color, W, CI | C, M, Y, K, Lm, Lc, W, CI |
| Media | Max. printing width | 2500 mm |
| | Maximum width | 3100 mm |
| | Thickness | 60 mm or less (54 mm or less when using automatic media thickness measurement) |
| | Weight | Up to 50 kg/m ² |
| Distance accuracy ^{*6} | Absolute accuracy | ±0.3 mm or ±0.3 % of specified distance, whichever is greater |
| | Duplicability | ±0.2 mm or ±0.1 % of specified distance, whichever is greater |
| Perpendicularity | | ±0.5 mm / 500 mm |
| Printing gap | | 1.5 to 3.0 mm (media thickness detected automatically) |
| Origin alignment | | LED pointer |
| Ink supply | | Ink bottle |
| Maintenance liquid feed | | N/A |
| Waste ink tank | | Bottle type (2,600 ml) |
| Media retention | | Held in place by a vacuum unit |
| NCU (Nozzle clogging detection) | | Provided |
| UV unit | | Water-cooled UV-LED emitters ×2 (one each on left and right) |
| Interface | Data transfer function | 10GBASE-T Ethernet |
| Languages | | English, Japanese |
| Noise levels | During standby | Not exceeding 60 dB (A) |
| | In operation (continuous) | Not exceeding 75 dB (A) |
| Compliance with standards | | UL62368-1 ETL compliance, CE marking (EMC Directive, Machinery Directive), RoHS, REACH, RCM marking, KC certified, UKCA marking |
| Power supply specifications ^{*1} | | Single-phase 200 to 240 V AC ±10 % / 24 A ×3, 50/60 Hz ±1 Hz |
| Power consumption ^{*2} | | Not exceeding 4,800 W ×3 |
| Installation environment ^{*3} | Permissible ambient temperature | 20 to 30 °C |
| | Relative humidity | 35 to 65 %RH (no condensation) |

| Item | | JFX600-2531 |
|---------------------------|---|--|
| | Temperature range in which accuracy is guaranteed | 20 to 25 °C |
| | Temperature gradient | Not more than ± 10 °C/h |
| | Dust | 0.15 mg/m ³ (typical office) |
| | Maximum operating altitude | 2000 m |
| External dimensions *4 | Width (W) | Max. 5,400 mm |
| | Depth (D) | Max. 5,600 mm |
| | Height (H) | Max. 1,700 mm |
| Package dimensions *5 | Main unit | 2,850 mm (W) × 5,900 mm (D) × 2,000 mm (H) |
| | Table | 2,850 mm (W) × 4,800 mm (D) × 1,400 mm (H) |
| Weight | | Max. 1,500 kg |
| Package weight *5 | Main unit | 2,200 kg |
| | Table | 1,200 kg |

*1. Excluding options

*2. Varies depending on print mode.

*3. Use in an environment not exposed to direct sunlight. Ink discharge will become less consistent under conditions outside this range.

*4. Dimensions shown do not include the touch panel (accessory).

*5. The packaging consists of two boxes, one each for the main unit and table.

*6. Excluding media size variation and fluctuations at initial loading.

6.2 LICENSE Library

Mimaki printer Firmware

Copyright ©2020 MIMAKI ENGINEERING CO.,LTD. All rights reserved.

This product contain open source software listed in the tables below.

| Component | License |
|---|---------|
| StarterWare for ARM® based TI Sitara Processors | BSD-TI |

The following license terms and conditions shall apply to the open source software listed in the table above:

BSD-TI

Copyright (C) 2010 Texas Instruments Incorporated - <http://www.ti.com/>

Redistribution and use in source and binary forms, with or without modification, are permitted provided that the following conditions are met:

1. Redistributions of source code must retain the above copyright notice, this list of conditions and the following disclaimer.
2. Redistributions in binary form must reproduce the above copyright notice, this list of conditions and the following disclaimer in the documentation and/or other materials provided with the distribution.
3. Neither the name of Texas Instruments Incorporated nor the names of its contributors may be used to endorse or promote products derived from this software without specific prior written permission.

THIS SOFTWARE IS PROVIDED BY THE COPYRIGHT HOLDERS AND CONTRIBUTORS "AS IS" AND ANY EXPRESS OR IMPLIED WARRANTIES, INCLUDING, BUT NOT LIMITED TO, THE IMPLIED WARRANTIES OF MERCHANTABILITY AND FITNESS FOR A PARTICULAR PURPOSE ARE DISCLAIMED. IN NO EVENT SHALL THE COPYRIGHT OWNER OR CONTRIBUTORS BE LIABLE FOR ANY DIRECT, INDIRECT, INCIDENTAL, SPECIAL, EXEMPLARY, OR CONSEQUENTIAL DAMAGES (INCLUDING, BUT NOT LIMITED TO, PROCUREMENT OF SUBSTITUTE GOODS OR SERVICES; LOSS OF USE, DATA, OR PROFITS; OR BUSINESS INTERRUPTION) HOWEVER CAUSED AND ON ANY THEORY OF LIABILITY, WHETHER IN CONTRACT, STRICT LIABILITY, OR TORT (INCLUDING NEGLIGENCE OR OTHERWISE) ARISING IN ANY WAY OUT OF THE USE OF THIS SOFTWARE, EVEN IF ADVISED OF THE POSSIBILITY OF SUCH DAMAGE.

Index

A

| | |
|--------------------------------|-----|
| Adjust negative pressure | 112 |
| Adjust positive pressure | 112 |
| Alarm | 106 |
| Alarm list..... | 124 |
| Antifreeze mixture | 150 |
| Apply change..... | 114 |
| Auto Maint. | 111 |
| Auto vacuum | 117 |

B

| | |
|-------------------------------------|---------|
| Bi-direction adjustment value | 80, 122 |
| Bi-directional adjustment | 80, 122 |
| bottle cap..... | 46, 48 |
| bottle cap..... | 48 |
| Browser area | 110 |

C

| | |
|---------------------------------------|----------------------------------|
| Cable carrier | 30 |
| Cap | 129, 132 |
| Capping station | 30, 32 |
| Carriage..... | 30, 32, 129, 134 |
| Cleaning | 78, 107, 111 |
| Cleaning (Standby)..... | 111 |
| Cleaning before print | 111 |
| Cleaning the ink discharge path | 112, 136 |
| Clear..... | 114 |
| Clear alarm | 109 |
| Color profile | 42 |
| Consumables | 129, 145 |
| Continuous print | 92, 107 |
| Control PC | 31, 35, 36, 83, 87, 89, 124, 125 |
| Cooling unit | 150 |
| Cooling water unit..... | 31 |
| Correction of Dot Position | 80 |

D

| | |
|---------------------------------|-------------------------|
| Daily maintenance | 112, 130, 132, 134, 156 |
| Daily station maintenance | 112, 130, 132, 134 |

| | |
|--------------------------------|---------------|
| Delete job | 110 |
| Detailed Job Information | 93 |
| DISCLAIMERS | 5 |
| Distance correction..... | 124 |
| Document | 124 |
| Drop.PosCorrect..... | 54 |
| <hr/> | |
| E | |
| <hr/> | |
| Ejection failures | 77 |
| Emergency stop switch | 30 |
| Error List..... | 124 |
| Exection times | 93 |
| <hr/> | |
| F | |
| <hr/> | |
| Flushing (Standby) | 111 |
| Flushing filter | 147 |
| Folder | 110 |
| Foot switch | 31 |
| <hr/> | |
| G | |
| <hr/> | |
| Grease up X-LM block..... | 112 |
| <hr/> | |
| H | |
| <hr/> | |
| HDD disk space..... | 124 |
| Head Cleaning..... | 78 |
| Head maintenance | 112, 134, 156 |
| History | 106, 123 |
| HotFolder setting | 122 |
| <hr/> | |
| I | |
| <hr/> | |
| Illuminance | 94 |
| Ink..... | 106 |
| Ink discharge channel | 129, 136 |
| Ink End | 44 |
| Ink expired..... | 124 |
| Ink fillup (Print head) | 111, 155, 156 |
| Ink IC chip | 50 |
| Ink IC chip slot..... | 31 |
| Ink maintenance | 130 |
| INK NEAR-END..... | 44 |
| INK STATUS | 106, 107 |
| Ink status indicator lamp..... | 32 |

| | |
|--------------------------|------------|
| Ink status lamp | 31 |
| Ink Supply Unit | 31, 32, 50 |
| Ink wipe filter | 31, 148 |
| Installation guide | 42, 43 |
| Installation Space | 24 |
| Interference | 5 |
| Internal pattern | 75, 118 |
| Ionizer..... | 117 |

J

| | |
|----------------------|-----------------|
| Job..... | 35, 36, 83, 87 |
| Job history | 110 |
| Job import..... | 89, 110 |
| Job Information..... | 93 |
| Job status area..... | 110 |
| Jobs | 84, 86, 92, 110 |
| JOG operation | 65, 107, 122 |

L

| | |
|--|--------|
| LAN cable | 35 |
| Languages..... | 122 |
| License | 124 |
| Light curtain mode selector switch | 31 |
| Light Curtain | 30, 34 |
| Light-blocking cover | 45 |
| Local network | 36, 83 |
| Logical Seek..... | 117 |

M

| | |
|---------------------------------|-----------------|
| Machine information | 124 |
| Machine motion | 117 |
| Machine setting | 93 |
| Main power supply | 124 |
| Main power switch..... | 31, 125 |
| Maintenance | 106, 111 |
| Manual Log collection tool..... | 124 |
| MAPS* | 94, 117 |
| Measure | 71 |
| Measure media thickness..... | 70, 107, 122 |
| Media..... | 59, 72, 73, 122 |
| Media origin | 122 |
| Media suction valves | 31 |

| | |
|----------------------------------|--------------|
| Media thickness..... | 70 |
| Media thickness / Head gap | 72, 73, 122 |
| MENU | 106 |
| Mimaki driver | 41 |
| MIST FILTER..... | 146 |
| MPC..... | 35, 106, 110 |
| MPC user's guide | 124 |

N

| | |
|------------------------------------|----------------|
| Name | 120 |
| NCU..... | 32, 129, 133 |
| NCU ink pad | 147 |
| Network setting..... | 122 |
| Nozzle Check | 113 |
| Nozzle check before print..... | 111 |
| Nozzle image..... | 114 |
| Nozzle recovery table | 114 |
| Nozzle recovery table filter | 114 |
| Nozzle Recovery | 111, 112 |
| Numeric keypad | 68, 72, 82, 98 |

O

| | |
|---------------------------|---------------|
| Operation manual..... | 124 |
| Origin shift | 75, 118 |
| Origin shift margin | 75, 119 |
| Other maintenance..... | 112, 149, 151 |
| Over print..... | 94 |

P

| | |
|---------------------------------|----------|
| Pass | 93 |
| Pause | 96, 110 |
| PICT Up..... | 124 |
| PICT Up update..... | 124 |
| Power | 124 |
| Print | 117 |
| Print conditions/settings | 110 |
| Print direction | 94 |
| Print head | 73 |
| Print menu | 106, 110 |
| Print origin | 93, 94 |
| Print origin X..... | 93 |
| Print origin Y | 93 |

PRINTER STATUS..... 106, 107

Q

Queued jobs 110

QUICK MENU..... 107

R

RasterLink 42, 43, 83, 85, 88

Reboot System 124

Reference guide 85, 88

Refill cooling water 112, 151

Refresh 117

Regist nozzle recovery 112

Removable disk 87

Replace flushing filter 113

Replace NCU absorbent 113

Replace parts 113, 145, 147

Replace waste ink tank 112, 149

Replace Wiper 113, 145

Reset machine 124

Resume 97, 110

RIP software 35

S

Scan speed 94

Scroll buttons 114

Select head 117

Select head operation manual 117

Serial number 84, 87

Service maintenance mode 124

Setting 1 75, 106, 117

Setting 2 68, 72, 73, 80, 97, 106, 122

Shutdown system 125

Signal tower light 30, 33

Station 129

Stop 97, 110

Sub-tank maintenance 112

Suction valves 61

Support Video Link 124

Symbol 7

SYSTEM ALARM 106, 108

System information 41, 84, 87, 124

| | |
|----------------------------------|---------------|
| System menu | 106, 124 |
| System setting | 122 |
| <hr/> T <hr/> | |
| Table | 30, 129, 137 |
| Test pattern | 76, 110 |
| Test printing | 74, 107 |
| Tool | 124 |
| Touch panel | 31 |
| <hr/> U <hr/> | |
| Unit | 122 |
| UV conditions | 117 |
| UV illuminance | 94, 120 |
| UV-LED lamp | 129, 135 |
| UV-LED Unit | 90 |
| <hr/> V <hr/> | |
| Vacuum | 107 |
| Version | 124 |
| View position | 97, 107, 122 |
| <hr/> W <hr/> | |
| Warning Labels | 26 |
| Waste ink tank | 30, 129, 149 |
| Weekly maintenance | 112, 133, 136 |
| Weekly station maintenance | 112, 133 |
| White ink | 75 |
| Wiper | 129, 130, 145 |
| Wiper bracket | 129 |
| Wiper cleaner | 129 |
| Work change | 117 |
| <hr/> Y <hr/> | |
| Y-bar | 30, 97, 129 |

Operation manual

November, 2024

MIMAKI ENGINEERING CO., LTD.

2182-3 Shigeno-otsu, Tomi-shi, Nagano 389-0512 JAPAN

D203830-11-29112024

