

# JV400-LX Daily Care



Make sure to wear the attached **goggles and glove** when you work.

With a view to using this machine in a better condition, please be sure to the following daily care **after at the end of the daily work**. Please refer to “Daily care manual” for the detail.

## Cleaning of around the heads

### 1. Perform [HEAD MAINT.], move the carriage to the maintenance position and open the left maintenance cover.

- (1) Press the **MAINT.** key in LOCAL.
- (2) Press the **ENTER** key.
- (3) Press **▲** **▼** to select [HEAD MAINT.].
- (4) Press the **ENTER** key.
- (5) Open the left maintenance cover.

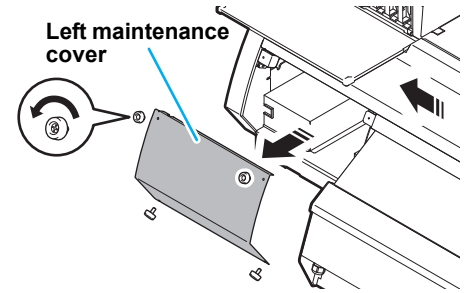

### 2. Wipe off the ink of around the head and groove with clean stick or waste cloth dipped in maintenance washing liquid LX.

Clean with a clean stick.

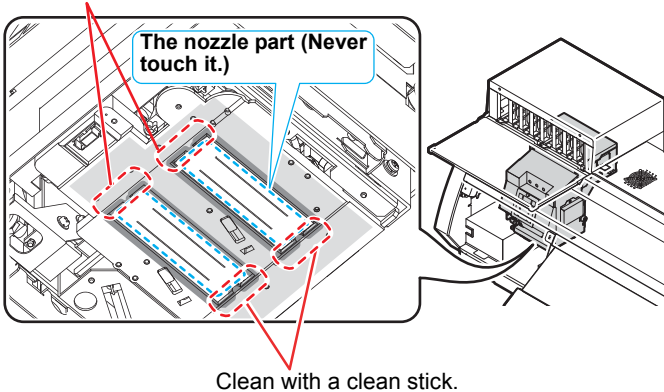

[Before cleaning]



[After cleaning]



**Important!**

- When you clean, fully be careful not to touch the nozzle surface.

### 3. Close the left maintenance cover.

### 4. Press **ENTER**, complete the cleaning.

## Cleaning of the station

### 1. Perform [STATION MAINT.], move the carriage to the maintenance position and open the right maintenance cover.

- (1) Press the **MAINT.** key in LOCAL.
- (2) Press the **ENTER** key.
- (3) Press **▲** **▼** to select [STATION MAINT.].
- (4) Press the **ENTER** key.
- (5) Open the right maintenance cover.

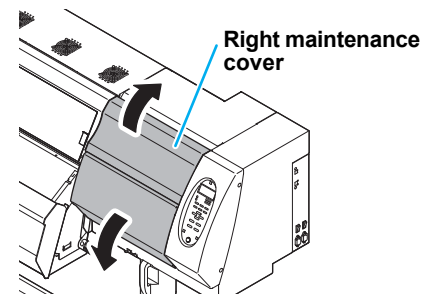

### ① Cleaning of the cap

Wipe off the ink of the cap rubber and cap cover with clean stick or waste cloth dipped in maintenance washing liquid LX.

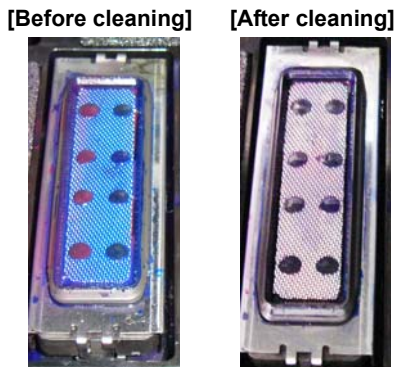
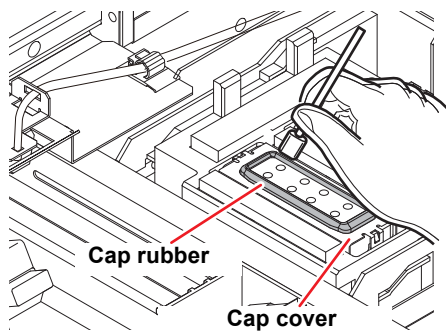

**Important!**

- Do not clean the mesh inside the cap at this point. Execute "DISWAY WASH" regularly (about once a week) to clean the mesh inside the cap. (Refer to "Operation Manual" chapter4)

### ② Cleaning of the wiper

Put the wiper that you used for one day into a provided case or solvent-resistance-covered-container (glass, earthenware, etc.) and pour maintenance washing liquid LX.

Take out the wiper and remove ink blot etc. with a Kimwipe®.

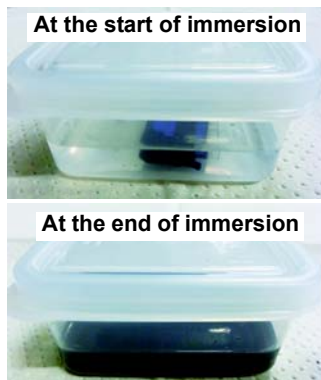
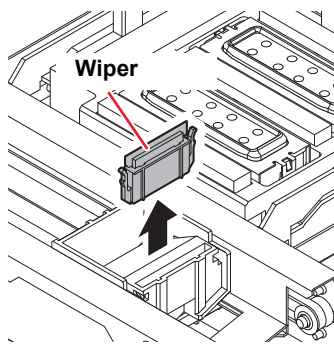

**Important!**

- Time to immerse the wiper shall be for 1 to 24 hours.
- Wipe off well so that any lint etc. do not remain on the top edge of the wiper film.

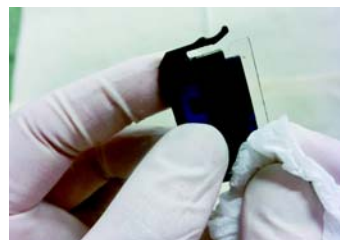

### ③ Cleaning of around the wiper

Wipe off around the wiper with clean stick dipped in maintenance washing liquid LX.

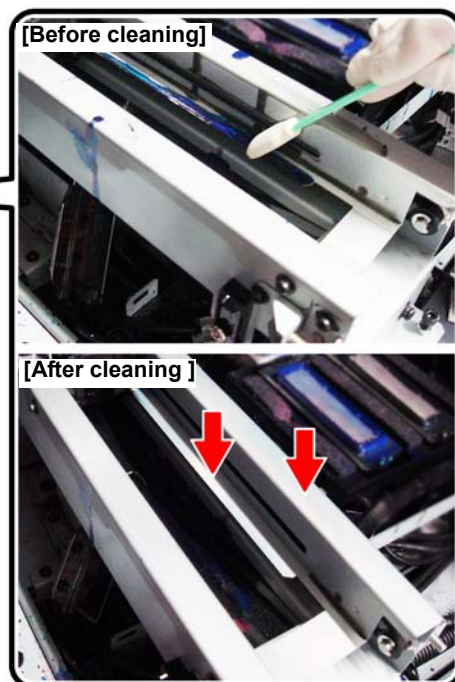
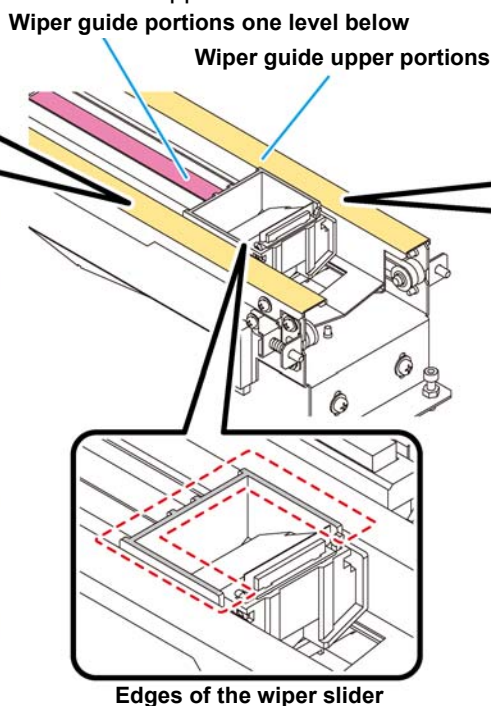
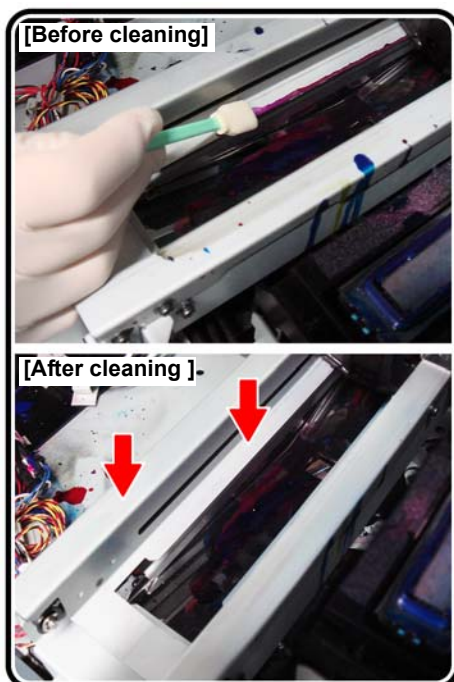

2. Close the right maintenance cover.

3. Press **ENTER**, complete the cleaning.